

 **DMC Co., Ltd.**
Interface with Touch

Analog Resistive Touch Screen Controller TSC-54/RU User's Guide

Table of Contents

1. Product Overview	2
1.1. Products Applicable.....	2
1.2. Overview	2
1.3. Peripheral Composition Overview	3
2. Specifications	4
3. Connector	5
3.1. Explanation of a connector terminal	5
3.2. The mounted connector.....	5
4. Interface type	6
4.1. Serial mode	6
4.2. USB mode	6
5. Packing Specification	7
5.1. Outline.....	7
5.2. Packing material.....	7
5.3. Outer case and lot label.....	7
5.4. Product name label	8
6. Changes & Improvements	9
6.1. Version History	9
7. Warranty	10
7.1. Warranty Period	10
7.2. Warranty Target	10
7.3. Warranty Exceptions	10
8. Precautions for Use	11
8.1. General Handling	11
8.2. Others.....	11

Dimensional Drawing

1. Product Overview

1.1. Products Applicable

This specification is applicable to TSC-54/RU.

1.2. Overview

TSC-54/RU is a touch screen controller board that performs an A/D conversion of an analog signal of a 4-wire resistive touch screen, and transmits the coordinate data to the host in a 10-bit resolution serial correspondence at 9600bps and USB. TSC-54/RU can be used for various applications for its functions including the power saving mode, seven sampling speed settings (max. 150p/s *1), two external switch connections, and automatic calibration data loading with an external EEPROM.

§ TSC-54/RU TSC-54/RU dispenses a need to newly design the peripheral circuits, and can easily be used by connecting to the touch screen and the host. Using the driver software *2 enables the mouse emulation on various operation systems and dispenses the need to newly design the controller software.

In addition, the correction data can be saved in the IC on the board with the built-in EEPROM.

TSC-54/RU is the product compatible with software of the TSC-30 series.

*1: 150 transmissions of coordinate data per second.

*2: Please contact the local sales representatives for software availability.

TSC-54/RU is a succeeding model of the boards of the TSC-30 series. TSC-54/RU is lead-free and compliant with RoHS.

1.3. Peripheral Composition Overview

A resistive touch screen is operated by resistance sensitive system between two layers such as film or glass. Two pieces of transparent materials with conductive coating are placed in the same direction as two electrodes face each other. The touch screen is activated when these transparent conductive layers are pressed to contact each other with a finger or a pen. The one of these conductive layers functions as an X-coordinates electric circuits and the other as a Y-coordinates circuits. To measure the X-coordinates TSC-54/RU supplies voltage, V_{cc} to the one of X-coordinates electrodes with GND to the other. When the touch screen is pressed under this environment the voltage of the X-coordinates resistance is detected by the Y-coordinates electrode (A_{in}) at the input point ($x1$), where the X-Y coordinate resistance layers make contact. The detected voltage in supply side is higher than the GND side, which means ' $A_{in}=V_{cc}$ ' at the point 'E' and ' $A_{in}=0(*1)$ ' at the point 'A'. TSC-54/RU calculates coordinates data starting from A/D conversion of the ' A_{in} ' voltage. The Y-coordinates is measured in the same way. By repeating this process alternately, coordinate value at the input point is determined.

(*1) Excluding the loss in the controller circuits and touch screen. Actual detected voltage should be lower than ' $V_{cc} - GND$ ' because of loss happened in the circuitry.

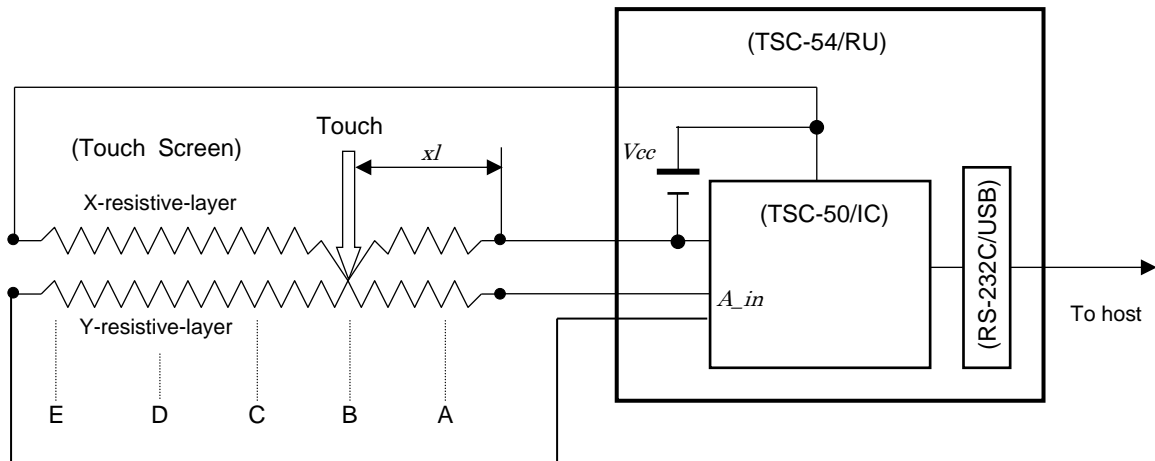
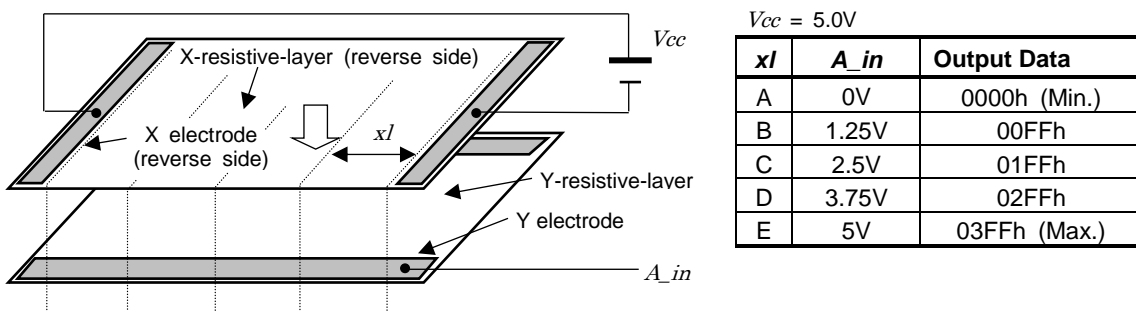

2. Specifications

General Specifications

Item		Rating	Remarks
Operating Temp.	Serial/USB	-20°C to +75°C	No dew condensation
Storing Temp.	Serial/USB	-20°C to +85°C	No dew condensation
Supply Voltage	Serial	DC 3.0V to 5.5V	
	USB	DC 3.0V to 5.25V	
Consumption Current		43mA	In serial mode, 50pps, Vin=5.0V, at touch input.
Correspondence (Serial)	Format	Asynchronous Serial	Fixed value
	Transfer Rate	9600bps	
	Data Format	8bit	
	Stop Bit	1bit	
	Parity	None	
Correspondence (USB)	Spec	USB Specification 2.0 Full Speed	
	Transfer Mode	Control transfer (command)	
		Interrupt transfer (coordinate)	
Device class	Vendor definition		
Frequency		16MHz	16MHz fixed
Dimension		30 x 53 mm	
Max height of components		4.8 mm	

Performance Specifications

Description	Rating	Note
Coordinate Output Rate (point/sec)	(1) point mode (2) 30p/s (3) 50p/s (4) 80p/s (5) 100p/s (6) 130p/s (7) 150p/s	Default: 150p/s with DMC original driver software. (TSC-DD)
Coordinate Resolution	10bit (1024 x 1024)	The value will be lower in the active area of the touch screen
Linearity Error	±3 LSB	
Input Response Time	10ms (TYP)	

3. Connector

3.1. Explanation of a connector terminal

CN	Terminal	Name	Function
CN2	1	XL	Touch screen Input XL.
	2	YU	Touch screen Input YU.
	3	XR	Touch screen Input XR.
	4	YD	Touch screen Input YD.
CN4*1	1	Vbus	USB Vbus
	2	D-	USB D-
	3	D+	USB D+
	4	GND	USB GND
	5	Shield	USB FG
CN5	1	Dout	RS-232C Data Output
	2	Din	RS-232C Data Input
	3	GND	RS-232C GND
CN6	1	Vin	Power Input
	2	GND	GND

*1: When you use it at 3.3V of the serial mode, please do not connect TSC-54/RU to Vbus of CN4.

3.2. The mounted connector

CN	P/N	Manufacturer
CN2	00-8370-049-000-800+	Kyosera Elco Corporation
CN4	S5B-PH-K-S	J.S.T. Mfg Co., Ltd
CN5	S3B-PH-K-S	J.S.T. Mfg Co., Ltd
CN6	S2B-PH-K-S	J.S.T. Mfg Co., Ltd

4. Interface type

TSC -54/RU has serial and USB interface type. You choose either type. You cannot use both these at the same time.

(Notice) In the state that connected a serial and a USB cable to a computer, please do not start power on of TSC-54/RU and computer. Because it may cause malfunction.

4.1. Serial mode

In serial mode, please use CN5 for connecting to host computer, and CN6 for power supply.

Specifications

Transmission format: Asynchronous serial

Transfer rate: 9600bps

Data format: 8 bit

Stop bit: 1 bit

Parity: None

4.2. USB mode

In USB mode, please use CN4 for connecting to host computer.

Specifications

Transmission spec: USB Specification 2.0 Full Speed

Transfer mode: Control transfer (Command) / Interrupt transfer (Coordinate)

Device class: Vendor definition

5. Packing Specification

5.1. Outline

TSC-54/RU is wrapped up in the air packing of the prevention of static protection type and puts it in a packing box.

5.2. Packing material

Outer case: 75 x 55 x 15 mm, clay coated newsback board

Cushioning: 120 x 70 mm, air packing, static protection

5.3. Outer case and lot label

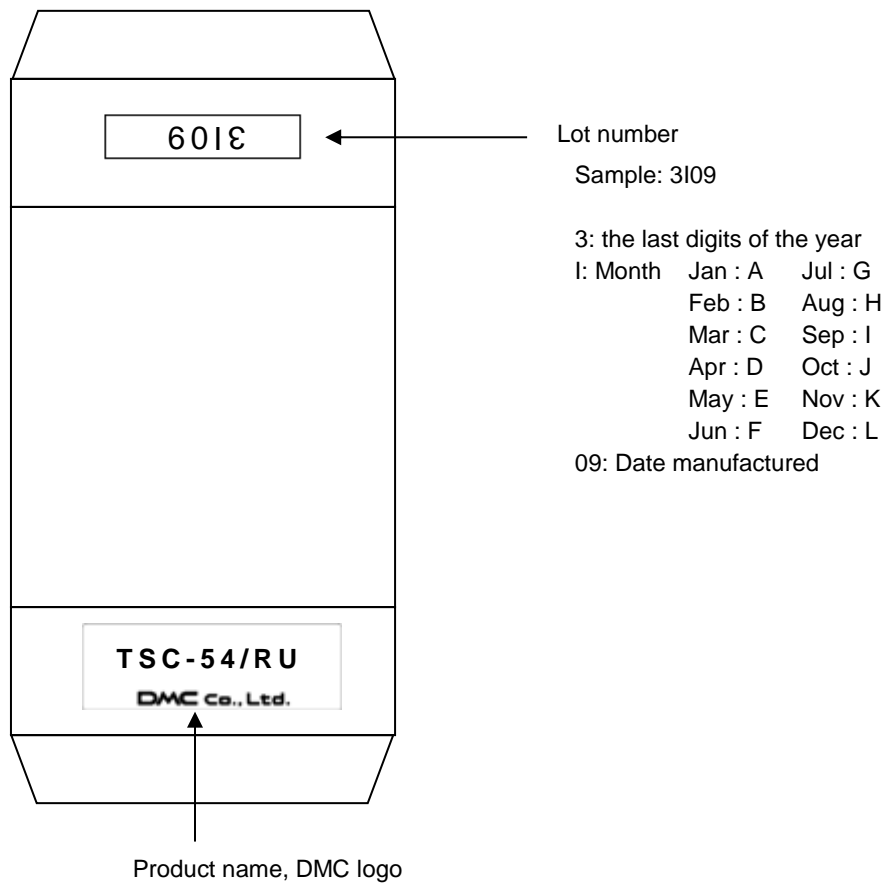

5.4. Product name label

Backside of board

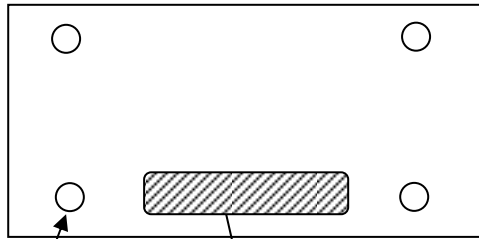

Screw Hole

Product Name Label

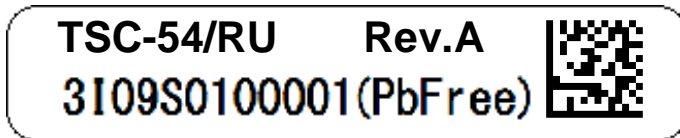

TSC-54/RU: Product name
Lot#: 3I09S0100001

Definitions of the lot number

① 3I09

3: the last digits of the year

I: Month Jan : A Jul : G

 Feb : B Aug : H

 Mar : C Sep : I

 Apr : D Oct : J

 May : E Nov : K

 Jun : F Dec : L

09: Date manufactured

② S01: Control number for DMC use

③ 00001: Serial number (5 digits)

Rev: Revision information

(PbFree): lead free

Data Matrix: lot number [3I09S0100001] can be read with a barcode reader. (Product name and revision information are not included.)

6. Changes & Improvements

6.1. Version History

§ TSC-54/RU

Ver0.1 (November 20, 2015)

Draft release

Ver1.0 (March 31, 2016)

First edition release

2. Specifications Consumption Current is described in General Specifications.

Ver1.1 (May 9, 2016)

5.4. Product Name Label: Label contents changes (applied from mass production)

5.3. Outer case and lot label: The example of lot number changes to be same as 5-4.

Ver2.0 (June 25, 2021)

1.2. Overview: Added the description that EEPROM is built in TSC-54 / RU.

2. Specifications: Revised the Operating Temp of General Specifications.

5.4. Product name label: Corrected the QR code to Data Matrix.

7. Warranty

7.1. Warranty Period

- § The warranty period is limited to 1 year from the date of shipping. The warranty for the initial deflection such as appearance deflection is limited to 1 month.
- § Any defected parts under proper use will be examined by the supplier and replaced by the new parts if the deflection is considered to be caused by the supplier.
- § The replacement is subject to be included in the next lot.

7.2. Warranty Target

- § The warranty only covers the product itself and does not cover any damage to others caused by using this product. Onsite repair or replacement is not supported.
- § We will do our best for delivery problem and product deflections, but the warranty for the production line is not covered.

7.3. Warranty Exceptions

Following conditions are not covered with the warranty and subject to charge.

- § Any malfunctions and damages during transportation and transfer by the user.
- § Any malfunctions and damages caused by a natural disaster or a fire.
- § Any malfunctions and damages caused by static electricity
- § Any malfunctions and damages caused by the failure of the associated equipment.
- § If the product is remodeled, disassembled or repaired by the user.
- § If the product is glued onto the equipment and uninstalled.
- § Any malfunctions and damages caused by an improper usage and handling against the specifications and notes.

8. Precautions for Use

8.1. General Handling

- § Keep the product away from any conductive objects while in use.
- § Do not touch the conductive part of the product to avoid being damaged by the electrostatic discharge. Follow the proper procedure for handling.
- § Keep the product in the proper storing environment and avoid any load to the product.
- § Do not use or store the product in the severe condition like following:
 - Wet environment or a condition where the product is likely to get wet.
 - Where dew condensation is likely to occur.
 - Near solvent or acid.
- § Do not take apart or alter the product.

8.2. Others

- § The contents of this document are subject to change without notice.
- § The manufacturer or sales representatives will not be liable for any damages or loss arising from use of this product.
- § This product is intended for use in standard applications (computers, office automation, and other office equipment, industrial, communications, and measurement equipment, personal and household devices, etc.) Please avoid using this product for special applications where failure or abnormal operation may directly affect human lives, or cause physical injury or property damage, or where extremely high levels of reliability are required (such as aerospace systems, vehicle operating control, atomic energy controls, medical devices for life support, etc.).
- § Any semiconductor devices have inherently a certain rate of failure. The user must protect against injury, damage, or loss from such failures by incorporating safety design measures into the user's facility and equipment.

TSC-54/RU User's Guide
Rev. 2.0, June 25, 2021
©2021 DMC Co., Ltd.

This document can be freely distributed, but any alternation to this document is prohibited.

Component side

Back side

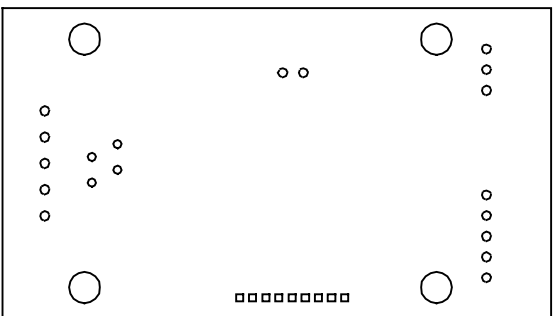
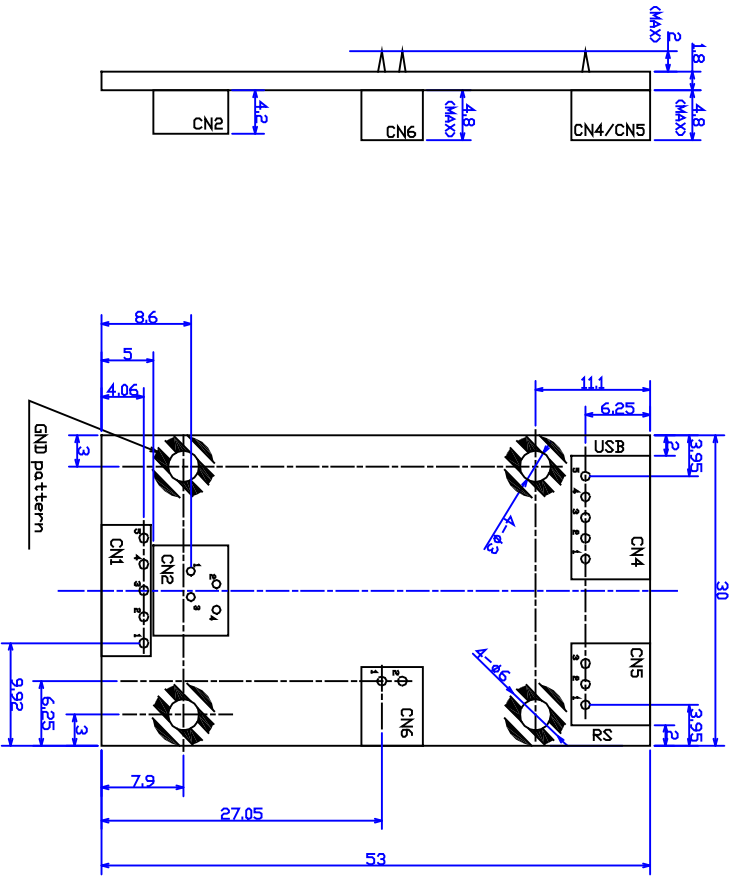

Unit = mm

Date	P/N
November 20, 2015	TSC-54/RU
Name	
Dimensional Drawing	Rev.1
DMC CO., LTD.	