

User's Manual

ECM-A50M

3,5" AMD eOntario Module

2nd Ed - February 2012

FCC Statement



THIS DEVICE COMPLIES WITH PART 15 FCC RULES. OPERATION IS SUBJECT TO THE FOLLOWING TWO CONDITIONS:

(1) THIS DEVICE MAY NOT CAUSE HARMFUL INTERFERENCE.

(2) THIS DEVICE MUST ACCEPT ANY INTERFERENCE RECEIVED INCLUDING INTERFERENCE THAT MAY CAUSE UNDESIRE OPERATION.

THIS EQUIPMENT HAS BEEN TESTED AND FOUND TO COMPLY WITH THE LIMITS FOR A CLASS "A" DIGITAL DEVICE, PURSUANT TO PART 15 OF THE FCC RULES.

THESE LIMITS ARE DESIGNED TO PROVIDE REASONABLE PROTECTION AGAINST HARMFUL INTERFERENCE WHEN THE EQUIPMENT IS OPERATED IN A COMMERCIAL ENVIRONMENT. THIS EQUIPMENT GENERATES, USES, AND CAN RADIATE RADIO FREQUENCY ENERGY AND, IF NOT INSTALLED AND USED IN ACCORDANCE WITH THE INSTRUCTION MANUAL, MAY CAUSE HARMFUL INTERFERENCE TO RADIO COMMUNICATIONS.

OPERATION OF THIS EQUIPMENT IN A RESIDENTIAL AREA IS LIKELY TO CAUSE HARMFUL INTERFERENCE IN WHICH CASE THE USER WILL BE REQUIRED TO CORRECT THE INTERFERENCE AT HIS OWN EXPENSE.

Copyright Notice

Copyright © 2012 Avalue Technology Inc., ALL RIGHTS RESERVED.

No part of this document may be reproduced, copied, translated, or transmitted in any form or by any means, electronic or mechanical, for any purpose, without the prior written permission of the original manufacturer.

A Message to the Customer

Avalue Customer Services

Each and every Avalue's product is built to the most exacting specifications to ensure reliable performance in the harsh and demanding conditions typical of industrial environments. Whether your new Avalue device is destined for the laboratory or the factory floor, you can be assured that your product will provide the reliability and ease of operation for which the name Avalue has come to be known.

Your satisfaction is our primary concern. Here is a guide to Avalue's customer services. To ensure you get the full benefit of our services, please follow the instructions below carefully.

Technical Support

We want you to get the maximum performance from your products. So if you run into technical difficulties, we are here to help. For the most frequently asked questions, you can easily find answers in your product documentation. These answers are normally a lot more detailed than the ones we can give over the phone. So please consult the user's manual
2 ECM-A50M User's Manual

ECM-A50M User's Manual

first.

To receive the latest version of the user's manual; please visit our Web site at:

<http://www.avalu.com.tw/>

If you still cannot find the answer, gather all the information or questions that apply to your problem, and with the product close at hand, call your dealer. Our dealers are well trained and ready to give you the support you need to get the most from your Avalue's products. In fact, most problems reported are minor and are able to be easily solved over the phone. In addition, free technical support is available from Avalue's engineers every business day. We are always ready to give advice on application requirements or specific information on the installation and operation of any of our products. Please do not hesitate to call or e-mail us.

Headquarters and Branch

Avalue Technology Inc.

7F, 228, Lian-cheng Road, Chung Ho City, Taipei,
Taiwan

Tel:+886-2-8226-2345

Fax: +886-2-8226-2777

Information: sales@avalu.com.tw

Service: service@avalu.com.tw

Avalue USA

Avalue Technology Inc.

9 Timber Lane, Marlboro, NJ 07746-1443

Tel: (732) 414-6500

Fax: (732) 414-6501

Information: sales@avalu-usa.com

Service: support@avalu-usa.com

BCM Advanced Research

BCM Advanced Research an Avalue Company

7 Marconi, Irvine, CA92618

Tel: +1-949-470-1888

Fax: +1-949-470-0971

Information: BCMSales@bcmcom.com

Web: www.bcmcom.com

Avalue Europe

Avalue Europe A/S

Moelledalen 22C, 3140

Aalsgaarde, Denmark

Tel: +45-7025-0310

Fax:+45-4975-5026

Information: sales.europe@avalu.com.tw

Service: service.europe@avalu.com.tw

Avalue China

Avalue Technology Inc.

Room 805, Building 9, No.99 Tianzhou Rd.,

Caohejing Development Area,

Xuhui District, Shanghai

Tel: +86-21-5169-3609

Fax:+86-21-5445-3266

Information: sales.china@avalu.com.cn

Service: service@avalu.com.tw

Avalue Japan

Avalue Technology Inc.

2F keduka-Bldg, 2-27-3 Taito,

Taito-Ku, Tokyo 110-0016 Japan

Tel: +81-3-5807-2321

Fax: +81-3-5807-2322

Information: sales.japan@avalu.com.tw

Service: service@avalu.com.tw

Product Warranty

Avalue warrants to you, the original purchaser, that each of its products will be free from defects in materials and workmanship for two years from the date of purchase.

This warranty does not apply to any products that have been repaired or altered by people other than repair personnel authorized by Avalue, or that have been subject of misuse, abuse, accident or improper installation. Avalue assumes no liability under the terms of this warranty as a consequence of such events. Because of Avalue's high quality-control standards and rigorous testing, most of our customers never need to use our repair service. If any of Avalue's products is defective, it will be repaired or replaced at no charge during the warranty period. For out-of-warranty repairs, you will be billed according to the cost of replacement materials, service time, and freight. Please consult your dealer for more details. If you think you have a defective product, follow these steps:

1. Collect all the information about the problem encountered. (For example, CPU type and speed, Avalue's products model name, hardware & BIOS revision number, other hardware and software used, etc.) Note anything abnormal and list any on-screen messages you get when the problem occurs.
2. Call your dealer and describe the problem. Please have your manual, product, and any helpful information available.
3. If your product is diagnosed as defective, obtain an RMA (return material authorization) number from your dealer. This allows us to process your good return more quickly.
4. Carefully pack the defective product, a complete Repair and Replacement Order Card and a photocopy proof of purchase date (such as your sales receipt) in a shippable container. A product returned without proof of the purchase date is not eligible for warranty service.
5. Write the RMA number visibly on the outside of the package and ship it prepaid to your dealer.

Contents

1. Getting Started	8
1.1 Safety Precautions	8
1.2 Packing List	8
1.3 Document Amendment History.....	9
1.4 Manual Objectives	10
1.5 System Specifications	11
1.6 Architecture Overview—Block Diagram.....	13
2. Hardware Configuration	14
2.1 Product Overview	15
2.2 Installation Procedure.....	17
2.2.1 Main Memory	18
2.3 Jumper and Connector List	20
2.4 Setting Jumpers & Connectors.....	22
2.4.1 Clear CMOS (JBAT1).....	22
2.4.2 Serial port 1 (COM1) signal selector (JRI1).....	22
2.4.3 Serial port 2 (COM2) signal selector (JRI2).....	23
2.4.4 Power connector (DCIN)	23
2.4.5 AT/ ATX power Input selector (JAT/ATX).....	24
2.4.6 +V5A connector in ATX (PWR_SB)	24
2.4.6.1 Signal Description –AT/ATX mode & Input power type	25
2.4.7 ErP Power saving mode selector (JDEEPS5)	26
2.4.8 Touch selector (JTSEL).....	27
2.4.9 Battery connector (BAT-WB).....	27
2.4.10 CPU fan connector (CPU_FAN)	28
2.4.11 Serial port 1 in RS-422/485 mode (J422/485)	29
2.4.12 Audio connector (JAUDIO).....	29
2.4.13 LCD backlight brightness adjustment (JVR).....	30
2.4.14 LCD Inverter Connector (JBKL)	31
2.4.14.1 Signal Description – LCD Inverter Connector (JBKL).....	31
2.4.15 Serial port 2 connector (JCOM2).....	32
2.4.16 Touch connector (JTOUCH).....	32
2.4.17 General purpose I/O connector (JDIO).....	33
2.4.18 Miscellaneous setting connector (JFP).....	34
2.4.19 Keyboard & Mouse connector (JKBMS).....	34
2.4.20 Low pin count interface connector (JLPC).....	35
2.4.21 SPI connector (JSPI).....	35

ECM-A50M User's Manual

2.4.22	LVDS connector (JLVDS).....	36
2.4.23	USB connector 0 & 1/ 4 & 5/ 2 & 3 (JUSB1/2/3).....	37
2.4.24	SATA1/2 Power connector (SATA1_PWR/ SATA2_PWR)	37
3	BIOS Setup	38
3.1	Introduction.....	39
3.2	Starting Setup.....	39
3.3	Using Setup.....	40
3.4	Getting Help	41
3.5	In Case of Problems	41
3.6	BIOS setup	42
3.6.1	Main Menu	42
3.6.1.1	System Language	42
3.6.1.2	System Date	42
3.6.1.3	System Time	42
3.6.2	Advanced BIOS settings	43
3.6.2.1	PCI Subsystem Settings	44
3.6.2.1.1	PCI Express Settings	45
3.6.2.2	ACPI Settings.....	47
3.6.2.3	CPU Configuration	48
3.6.2.3.1	Node 0 Information	49
3.6.2.4	IDE Configuration.....	49
3.6.2.5	USB Configuration	50
3.6.2.6	H/W Monitor	51
3.6.2.7	Super IO Configuration	52
3.6.2.7.1	Serial Port 0 Configuration	53
3.6.2.7.2	Serial Port 1 Configuration	54
3.6.3	Advanced Chipset Features	55
3.6.3.1	North Bridge.....	55
3.6.3.1.1	GFX Configuration	56
3.6.3.1.2	Memory configuration	57
3.6.3.1.1	Node 0 Information	58
3.6.3.2	North Bridge LVDS configuration	59
3.6.3.3	South Bridge	60
3.6.3.3.1	SB SATA Configuration	61
3.6.3.3.2	SB USB Configuration	62
3.6.3.3.3	SB HD Azalia Configuration.....	62
3.6.4	Boot.....	63
3.6.5	Security	64
3.6.5.1	Administrator Password	64
3.6.5.2	User Password.....	64

ECM-A50M User's Manual

3.6.6	Save & Exit.....	65
3.6.6.1	Save Changes and Exit	65
3.6.6.2	Discard Changes and Exit	66
3.6.6.3	Save Changes and Reset	66
3.6.6.4	Discard Changes and Reset	67
3.6.6.5	Save Changes	67
3.6.6.6	Discard Changes	68
3.6.6.7	Restore Defaults	68
3.6.6.8	Save as user defaults	69
3.6.6.9	Restore as user defaults	69
3.6.6.10	Boot override.....	70
4.	Drivers Installation.....	71
4.1	Install Audio Driver (For Realtek ALC892).....	72
4.2	Install Ethernet Driver (For Realtek 8111E).....	73
4.3	Install Display Driver (For AMD Fusion Accelerated Processors).....	74
5.	Mechanical Drawing	75

1. Getting Started

1.1 Safety Precautions

Warning!



Always completely disconnect the power cord from your chassis whenever you work with the hardware. Do not make connections while the power is on. Sensitive electronic components can be damaged by sudden power surges. Only experienced electronics personnel should open the PC chassis.

Caution!



Always ground yourself to remove any static charge before touching the CPU card. Modern electronic devices are very sensitive to static electric charges. As a safety precaution, use a grounding wrist strap at all times. Place all electronic components in a static-dissipative surface or static-shielded bag when they are not in the chassis.

Always note that improper disassembling action could cause damage to the motherboard. We suggest not removing the heatsink without correct instructions in any circumstance. If you really have to do this, please contact us for further support.

1.2 Packing List

Before you begin installing your single board, please make sure that the following materials have been shipped:

- 1 x 3.5" ECM-A50M Micro Module
- 1 x Quick Installation Guide for ECM-A50M
- 1 x DVD-ROM contains the followings:
 - User's Manual (this manual in PDF file)
 - Ethernet driver and utilities
 - VGA drivers and utilities
 - Audio drivers and utilities
- 1 x Cable set contains the followings:
 - 1 x Audio cable (12pin, 2.0mm pitch)
 - 1 x USB cable (10P/2.54mm-10P/2.0mm)
 - 1 x Serial ATA cable (7-pin, standard)
 - 1 x Serial ATA cable (15-pin, 2P/2.0mm)
- 4 x D-sub Jack Screws

1.3 Document Amendment History

Revision	Date	By	Comment
2nd	February 2012	Avalue	Initial Release

1.4 Manual Objectives

This manual describes in details Avalue Technology ECM-A50M Single Board.

We have tried to include as much information as possible but we have not duplicated information that is provided in the standard IBM Technical References, unless it proved to be necessary to aid in the understanding of this board.

We strongly recommend that you study this manual carefully before attempting to set up ECM-A50M series or change the standard configurations. Whilst all the necessary information is available in this manual we would recommend that unless you are confident, you contact your supplier for guidance.

Please be aware that it is possible to create configurations within the CMOS RAM that make booting impossible. If this should happen, clear the CMOS settings, (see the description of the Jumper Settings for details).

If you have any suggestions or find any errors regarding this manual and want to inform us of these, please contact our Customer Service department with the relevant details.

1.5 System Specifications

System	
CPU	AMD G-series processor
BIOS	AMI 32M-bit SPI BIOS
System Chipset	AMD A50M
I/O Chip	Winbond W83627DHG-P
System Memory	One 204-pin DDR3 SODIMM socket, supports up to 4GB DDR3 1066/1333 SDRAM
SSD	1 x CompactFlash Type I/II socket
Watchdog Timer	Reset: 1 sec.-65535 sec./min. and 1 sec. or 1 min./step
H/W Status Monitor	Monitoring system temperature, voltage. Auto throttling control when CPU overheats
Expansion	Mini-PCIe (mSATA supported)
I/O	
MIO	2 x Serial ATA ports (7-pin with +5V power for SATADOM), 2 x Serial (COM2 with 5 x 2, pitch 2.0mm pin header. One COM can be set as RS-232/422/485 by BIOS), LPC (7 x 2, pitch 2.00mm pin header), 2 x SATA power connector (+5V)
USB	7x USB 2.0 ports (1 for edge connector, 3 for 5 x 2, pitch 2.0mm pin header)
IrDA	N/A
DIO	8-bit GPI, 8-bit GPO
Display	
Chipset	AMD Fusion Accelerated Processors
Display Memory	
Resolution	CRT mode: 2560 x 1200 & 18W, 1920 x 1200 & 9W LCD/Simultaneous mode : 1920 x 1200 @ 60 Hz
Multiple Display	CRT + LVDS, HDMI + LVDS, CRT + HDMI
LCD Interface	Dual channel 18/24-bit LVDS (transfer through DDI)
TV-out	N/A
Built-in Touch Screen (Optional)	
Chipset	PenMount 6000
Touch Screen Interface	With 9-pin 2.0mm box header (can be selected to support 4/5/8-wire touch screen)
Audio	

ECM-A50M User's Manual

AC97 Codec	Realtek ALC892 supports 7.1-CH Audio
Audio Interface	Min In, Line in, Line out
Ethernet	
LAN Chip	2 x Realtek 8111E
Ethernet Interface	10/100/1000 Base-Tx Gigabit Ethernet Compatible
Mechanical & Environmental	
Power Requirement	+12V
ACPI	Single power ATX Support S0, S3, S4, S5 ACPI 3.0 Compliant
Power Type	AT/ATX
Operating Temp.	0 to 60°C
Storage Temp.	-20~-80°C
Operating Humidity	0%~90% relative humidity, non-condensing
Size (L x W)	146 mm x 101 mm
Weight	TBD

1.6 Architecture Overview—Block Diagram

The following block diagram shows the architecture and main components of ECM-A50M

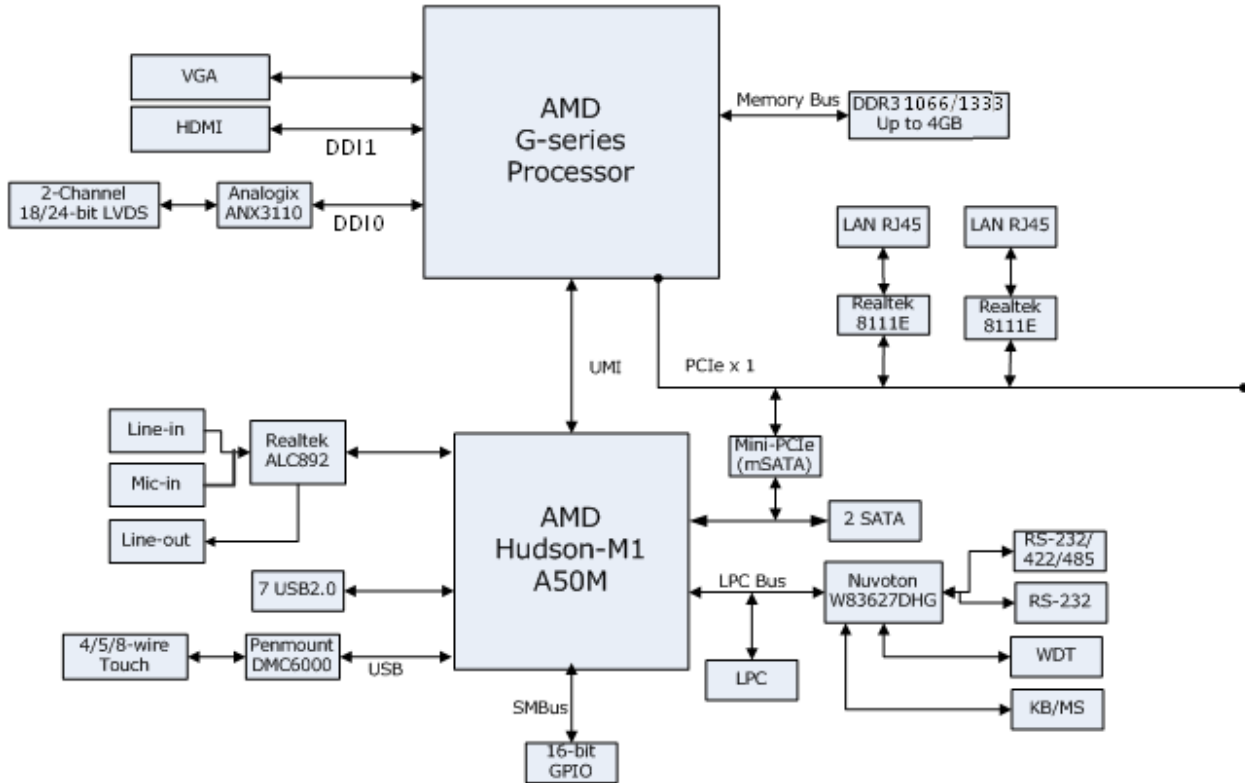

2. Hardware Configuration

2.1 Product Overview

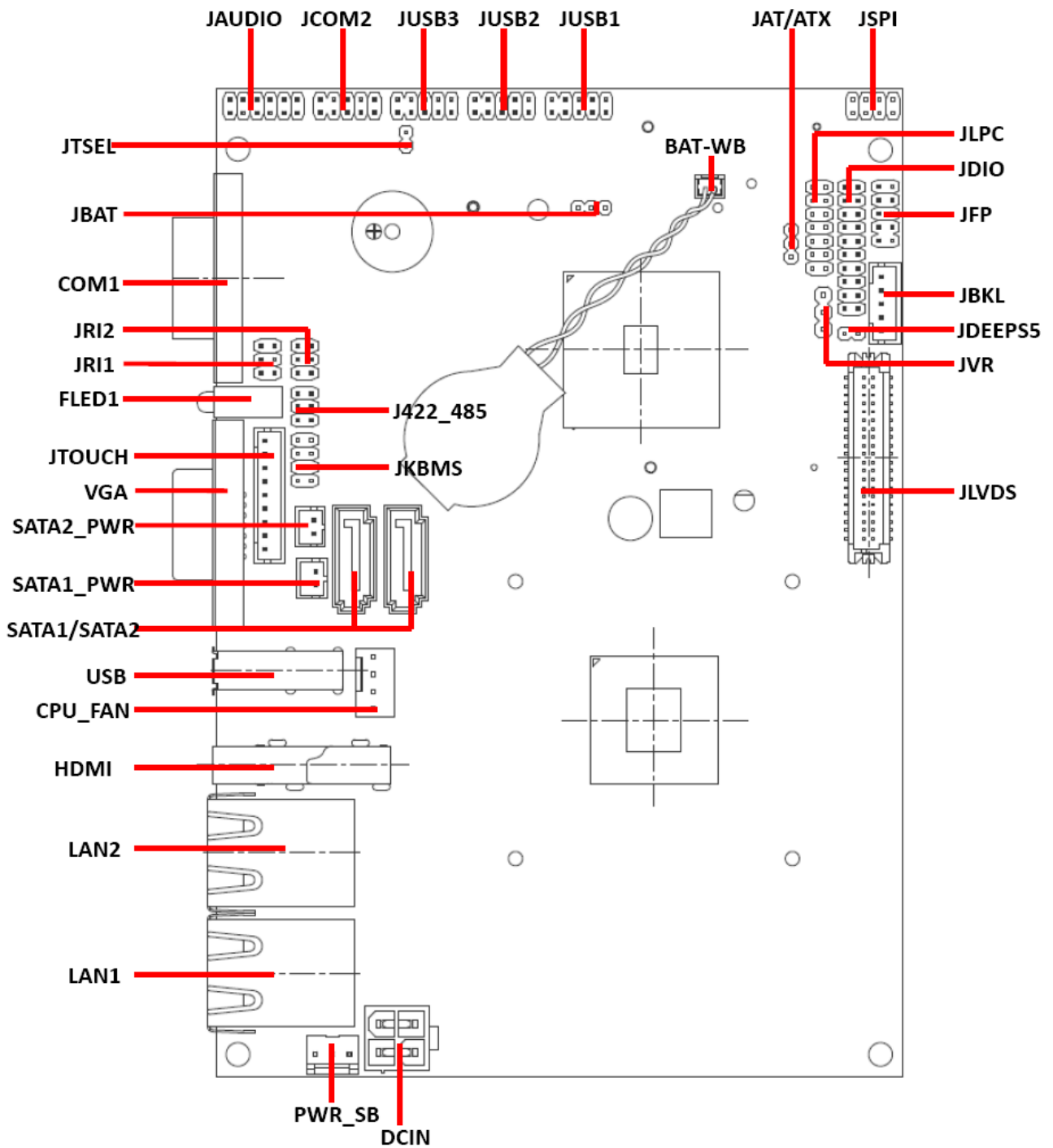

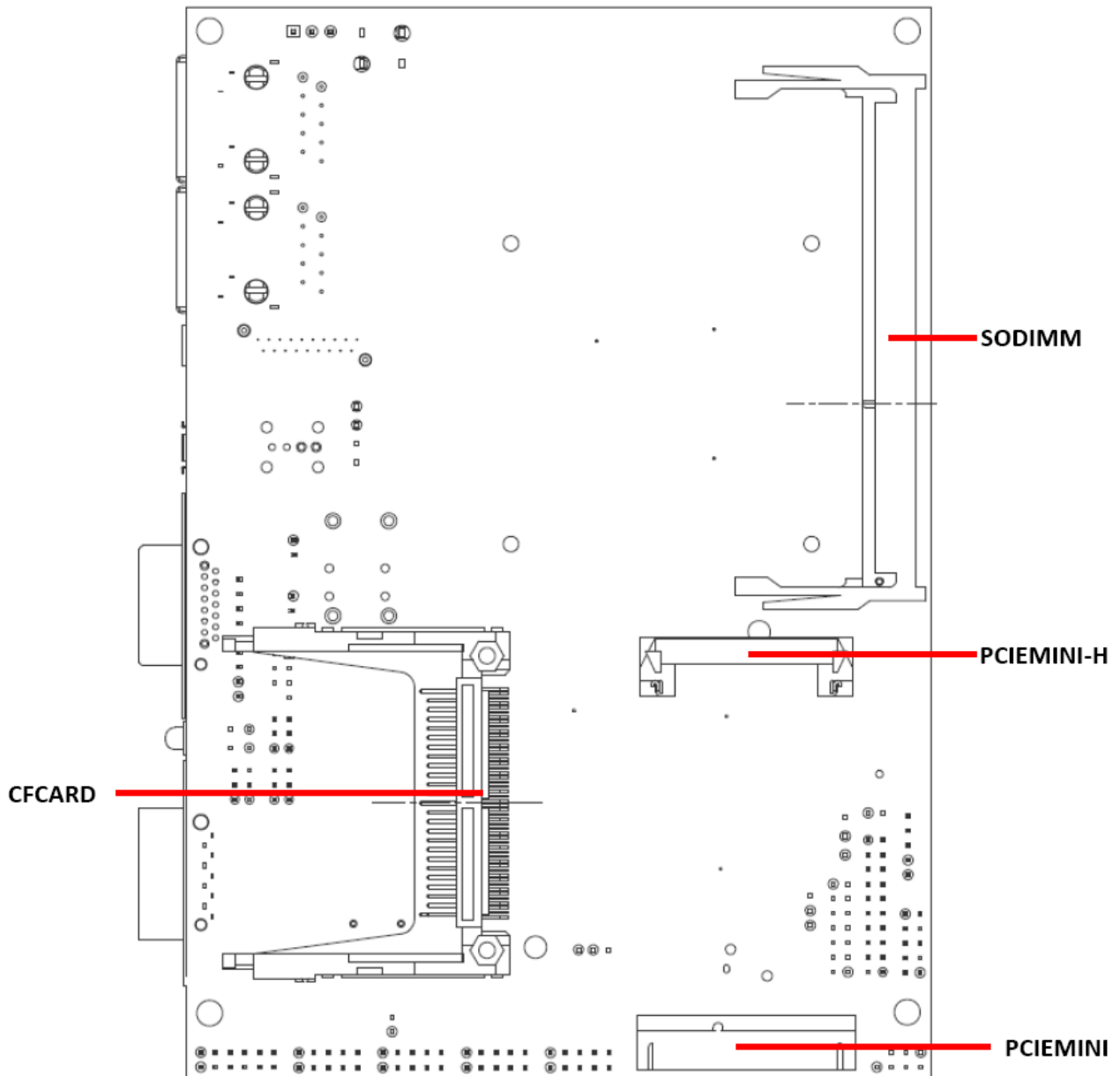

2.2 Installation Procedure

This chapter explains you the instructions of how to setup your system.

1. Turn off the power supply.
2. Insert the DIMM module (be careful with the orientation).
3. Insert all external cables for hard disk, floppy, keyboard, mouse, USB etc. except for flat panel. A CRT monitor must be connected in order to change CMOS settings to support flat panel.
4. Connect power supply to the board via the ATXPWR.
5. Turn on the power.
6. Enter the BIOS setup by pressing the delete key during boot up. Use the "LOAD BIOS DEFAULTS" feature. The **Integrated Peripheral Setup** and the **Standard CMOS Setup** Window must be entered and configured correctly to match the particular system configuration.
7. If TFT panel display is to be utilized, make sure the panel voltage is correctly set before connecting the display cable and turning on the power.

2.2.1 Main Memory

ECM-A50M provides one 204-pin DDR3 SODIMM socket, supports up to 4GB DDR3 1066/1333 SDRAM

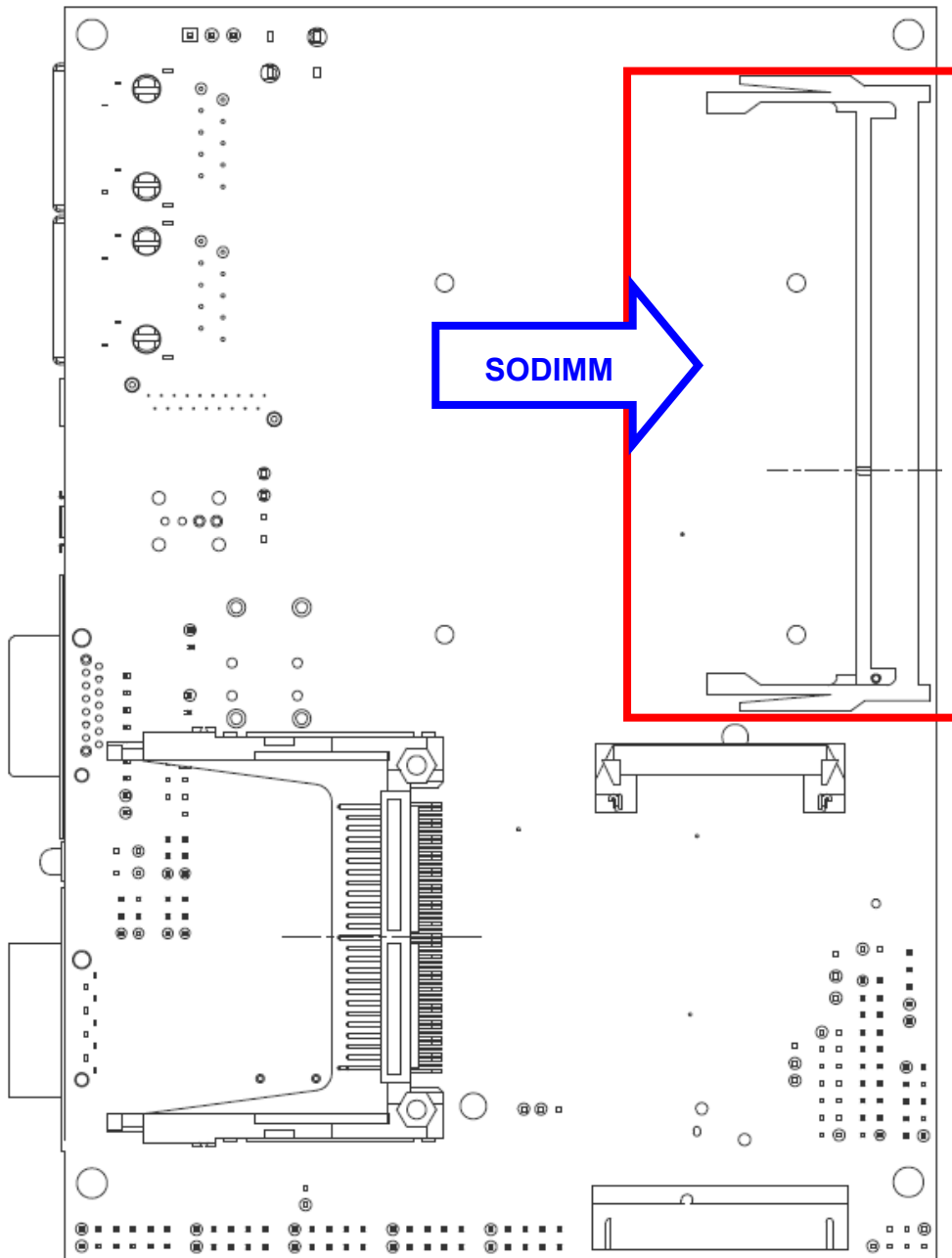

(Rear side)



Make sure to unplug the power supply before adding or removing DIMMs or other system components. Failure to do so may cause severe damage to board and components.

- Locate the SODIMM socket on the board.
- Carefully hold two edges of the SODIMM module. avoid touching its connectors.
- Align the notch key on the module with the rib on the slot.
- Firmly press the modules into the socket which automatically snaps into the mounting notch. Do not force the SODIMM module in with extra force as the SODIMM module only fits in one direction.

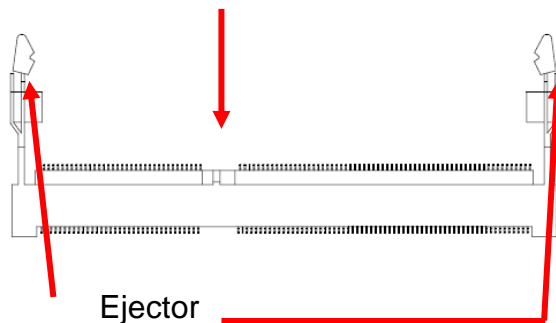
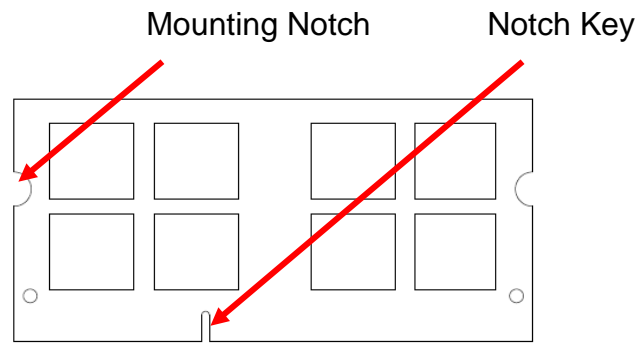

204-pin DDR3 SODIMM

- To remove SODIMM modules, simultaneously push the two ejector tabs outward, then pull out the SODIMM module.



Note:

- (1) Please do not change any DDR3 SDRAM parameter in BIOS setup to increase your system's performance without acquiring technical information in advance.
- (2) Static electricity can damage the electronic components of the computer or optional boards. Before proceeding, ensure that you are discharged of static electricity by briefly touching a grounded metal object.

2.3 Jumper and Connector List

You can configure your board to match the needs of your application by setting jumpers. A jumper is the simplest kind of electric switch.

It consists of two metal pins and a small metal clip (often protected by a plastic cover) that slides over the pins to connect them. To “close” a jumper you connect the pins with the clip. To “open” a jumper you remove the clip. Sometimes a jumper will have three pins, labeled 1, 2, and 3. In this case, you would connect either two pins.

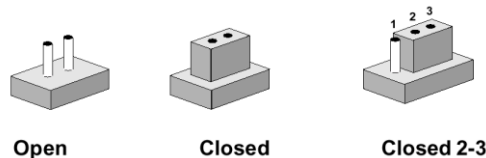

The jumper settings are schematically depicted in this manual as follows:



A pair of needle-nose pliers may be helpful when working with jumpers.

Connectors on the board are linked to external devices such as hard disk drives, a keyboard, or floppy drives. In addition, the board has a number of jumpers that allow you to configure your system to suit your application.

If you have any doubts about the best hardware configuration for your application, contact your local distributor or sales representative before you make any changes.

The following tables list the function of each of the board's jumpers and connectors.

Jumpers

Label	Function	Note
JBAT1	Clear CMOS	3 x 1 header, pitch 2.00 mm
JRI1	Serial port 1 (COM1) signal selector	3 x 2 header, pitch 2.0 mm
JRI2	Serial port 2 (COM2) signal selector	3 x 2 header, pitch 2.0 mm
JAT/ATX	AT/ ATX power Input selector	3 x 1 header, pitch 2.0 mm
JDEEPS5	ErP power saving mode selector	2 x 1 header, pitch 2.0 mm
JTSEL	Touch Selector	2 x 1 header, pitch 2.0 mm

Connectors

Label	Function	Note
BAT-WB	Battery connector	2 x 1 wafer, pitch 1.25 mm
COM1	Serial port 1 connector	D-sub 9-pin, male
CFCARD	CF card connector	
CPU_FAN1	CPU fan connector	4 x 1 wafer
DCIN	Power connector	2 x 2 wafer, pitch 4.2 mm
FLED1	LED connector	
HDMI	HDMI connector	19 pin
J422/485	Serial port 1 in RS-422/485 mode	3 x 2 header, pitch 2.0 mm
JAUDIO	Audio connector	6 x 2 header, pitch 2.0 mm
JBKL	LCD inverter connector	5 x 1 wafer, pitch 2.0 mm
JCOM2	Serial port 2 connector	5 x 2 header, pitch 2.0 mm
JDIO	General purpose I/O connector	10 x 2 header, pitch 2.0 mm
JFP	Miscellaneous setting connector	5 x 2 header, pitch 2.0 mm
JKBMS	Keyboard & Mouse connector	4 x 2 header, pitch 2.0 mm
JLPC	Low pin count interface connector	7 x 2 header, pitch 2.0 mm
JLVDS	LVDS connector	20 x 2 header, pitch 2.0 mm
JSPI	SPI connector	4 x 2 header, pitch 2.0 mm
JTOUCH	Touch Connector	9 X 1 wafer box, pitch 2.00 mm
JUSB1	USB connector 0 & 1	5 x 2 header, pitch 2.0 mm
JUSB2	USB connector 4 & 5	5 x 2 header, pitch 2.0 mm
JUSB3	USB connector 2 & 3	5 x 2 header, pitch 2.0 mm
JVR	LCD backlight brightness adjustment	3 x 1 header, pitch 2.54 mm
LAN1/ LAN2	RJ-45 Ethernet connector	
PCIEMINI	Mini PCI express connector	52 pin
PCIEMINI-H	Mini PCI express latch	
PWR_SB	+V5A connector in ATX	3 x 1 wafer, pitch 2.54 mm
SATA1_PWR	SATA1 power connector	2 x 1 wafer, pitch 2.0 mm
SATA2_PWR	SATA2 power connector	2 x 1 wafer, pitch 2.0 mm
SATA1	Serial ATA connector 1	
SATA2	Serial ATA connector 2	
SODIMM	204-pin DDR3 SODIMM connector	
USB	USB connector 6	
VGA	VGA connector	D-sub 15-pin, female

2.4 Setting Jumpers & Connectors

2.4.1 Clear CMOS (JBAT1)

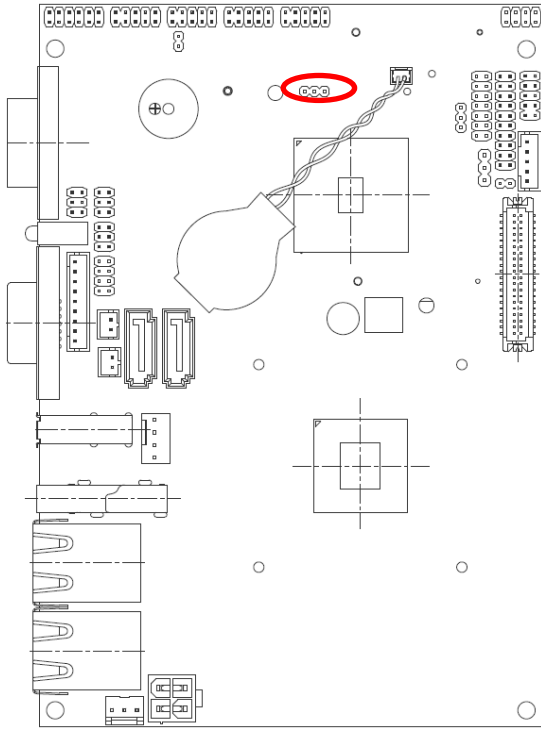

Protect*

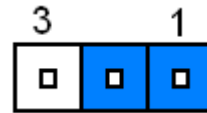

Clear CMOS

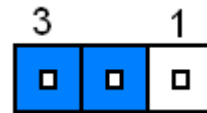

* Default

2.4.2 Serial port 1 (COM1) signal selector (JRI1)

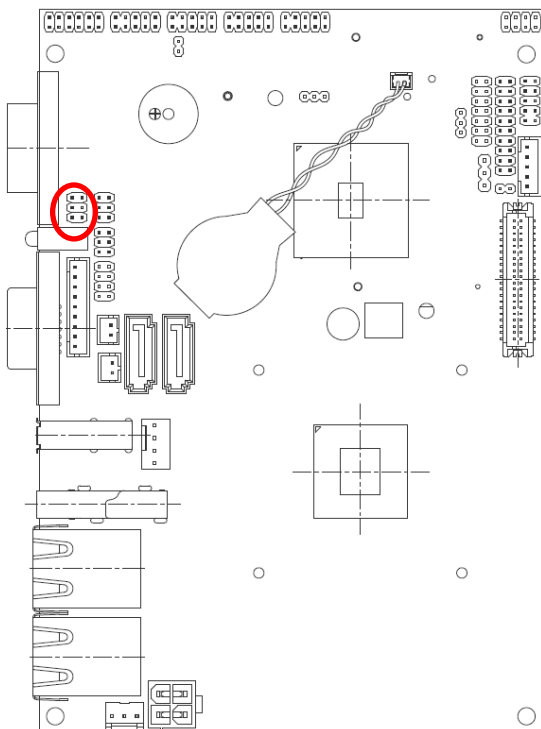

Ring*

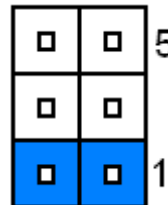

+5V

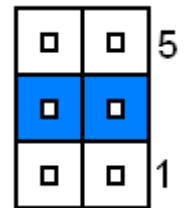

+12V

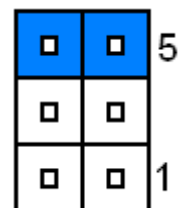

* Default

2.4.3 Serial port 2 (COM2) signal selector (JRI2)

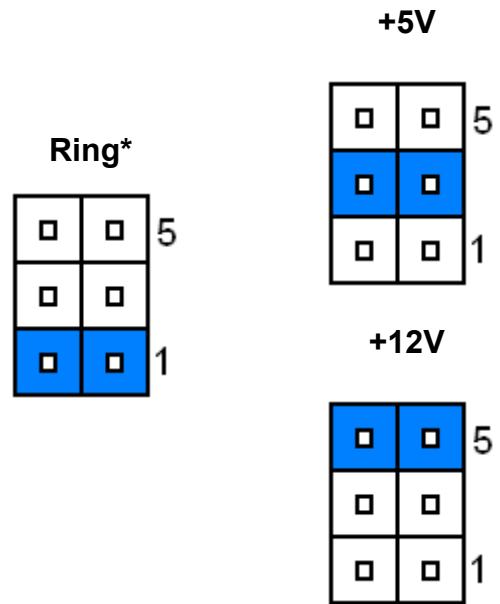
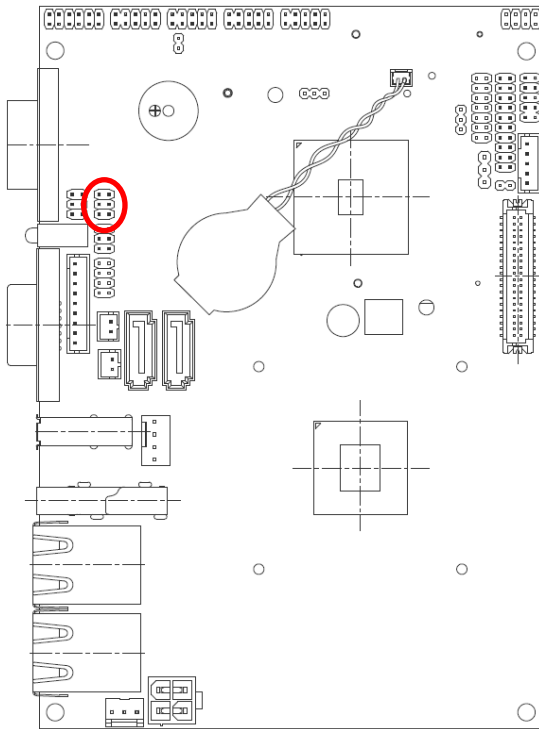

* Default

2.4.4 Power connector (DCIN)

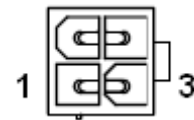
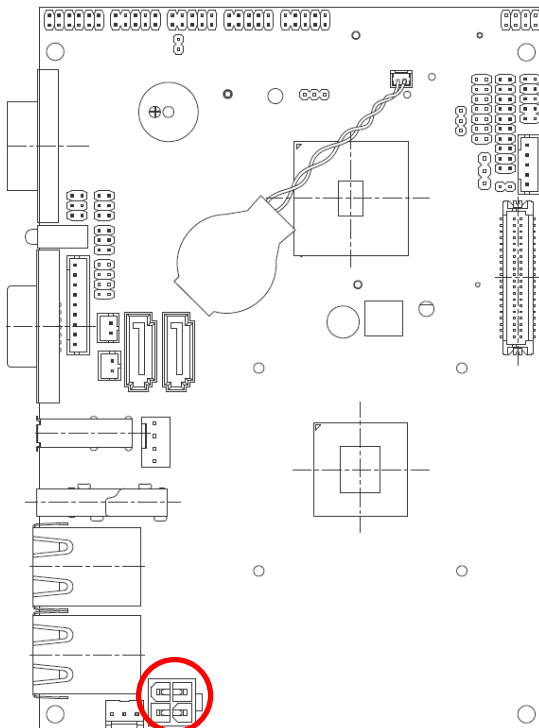

Signal	PIN	PIN	Signal
GND	2	4	VIN=12V
GND	1	3	VIN=12V

2.4.5 AT/ ATX power Input selector (JAT/ATX)

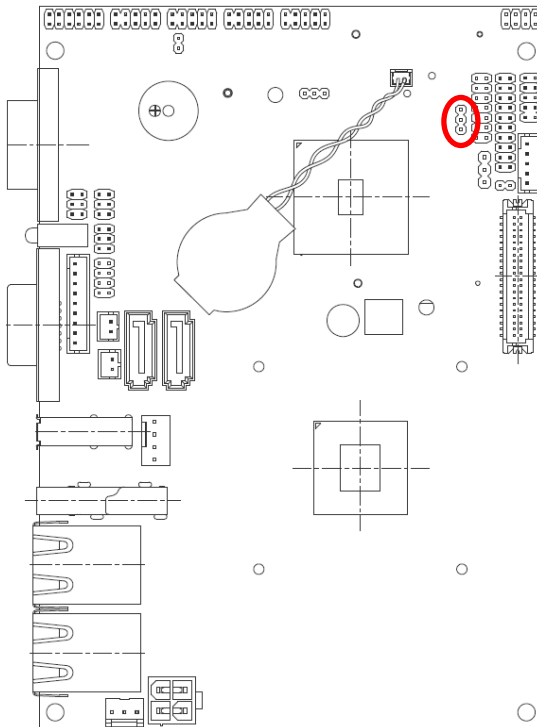

AT*

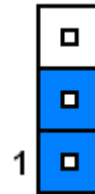

ATX



* Default

2.4.6 +V5A connector in ATX (PWR_SB)

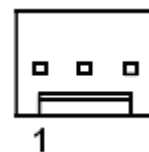
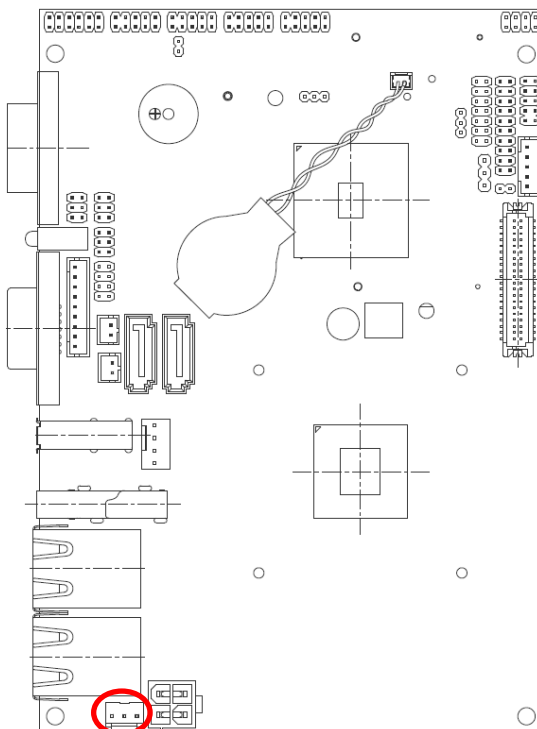

Signal	PIN
PSON	1
GND	2
+V5A	3

2.4.6.1 Signal Description –AT/ATX mode & Input power type

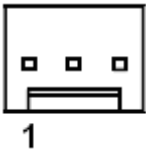
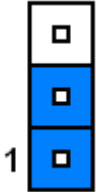
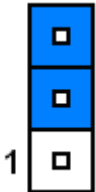
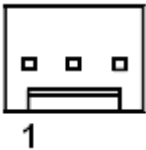
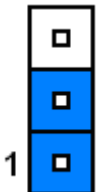
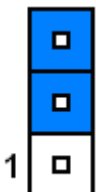
Input power type	Power-ON Mode	Description
<p>AT Type (DCIN)</p> 	<p>AT Mode (JAT/ATX)</p> 	<p>Use AT type power input, and set the board in AT mode.</p>
	<p>ATX Mode (JAT/ATX)</p> 	<p>Use AT type power input, and set the board in ATX mode.</p>
<p>ATX Type (PWR_SB)</p> 	<p>AT Mode (JAT/ATX)</p> 	<p>Use ATX type power input, and set the board in AT mode.</p>
	<p>ATX Mode (JAT/ATX)</p> 	<p>Use ATX type power input, and set the board in ATX mode.</p>

2.4.7 ErP Power saving mode selector (JDEEPS5)

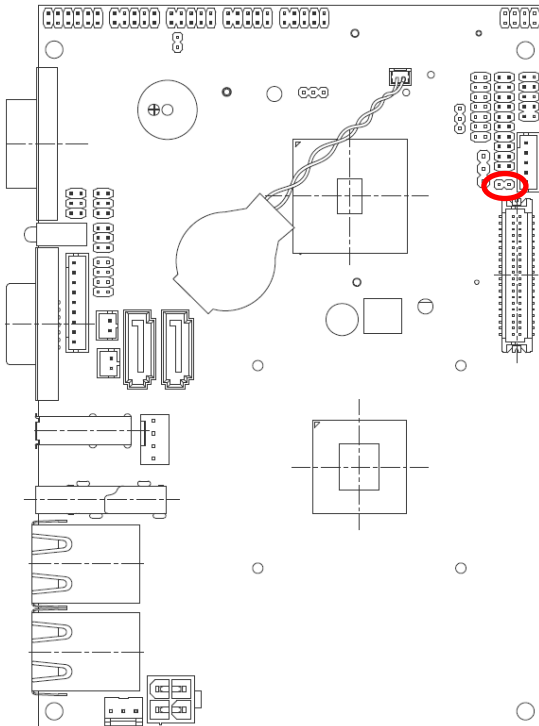

DEEPS5=0*



DEEPS5=1

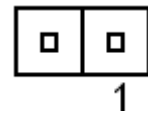

Signal	PIN
DEEPS5_SEL	1
GND	2

* Default

2.4.7.1 ErP Power saving mode selector setting details

Settings	Description
DEEPS5=0	System will not enter deep S5 state after AC power on, it remains in normal ACPI S5 state.
DEEPS5=1	System will enter deep S5 state 6 sec after AC power on.

2.4.8 Touch selector (JTSEL)

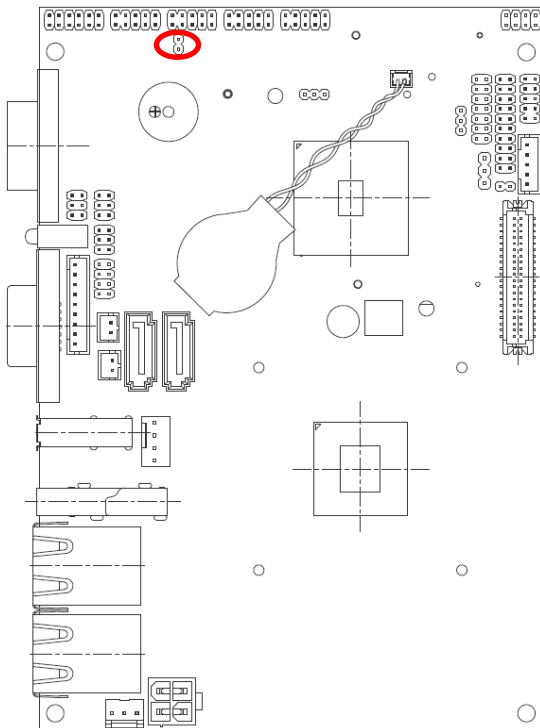

* Default

4/8W*

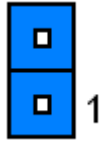

1

5W



1

Signal	PIN
CSENSE	2
CY-	1

JTOUCH	4-WIRE (5~8)	5-WIRE (4~8)	8-WIRE (1~8)
1	N/A	N/A	Right Sense
2	N/A	N/A	Left Sense
3	N/A	N/A	Bottom Sense
4	N/A	Sense	Top Sense
5	Right	LR	Right Excite
6	Left	LL	Left Excite
7	Bottom	UR	Bottom Excite
8	Top	UL	Top Excite
9	GND	GND	GND

2.4.9 Battery connector (BAT-WB)

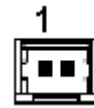
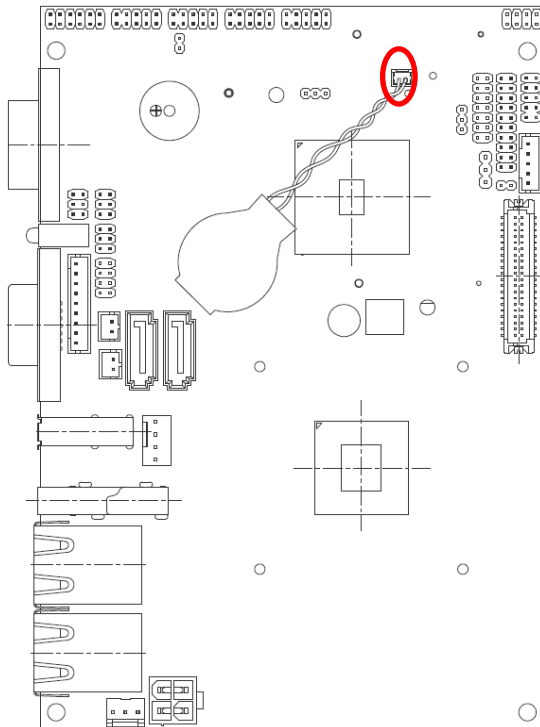

1

Signal	PIN
VBAT	1
GND	2

ECM-A50M User's Manual

2.4.10 CPU fan connector (CPU_FAN)

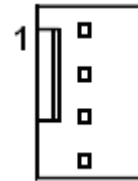
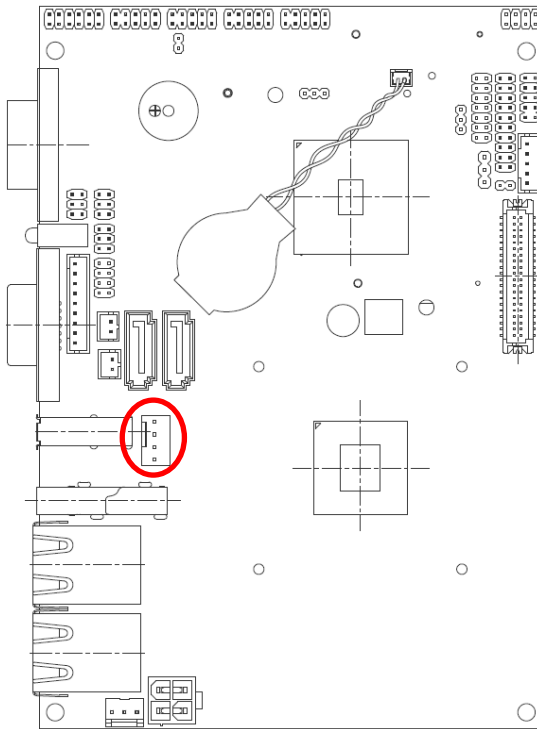

Signal	PIN
GND	1
+V12S	2
SIO_FANI	3
SIO_FANO	4

2.4.11 Serial port 1 in RS-422/485 mode (J422/485)

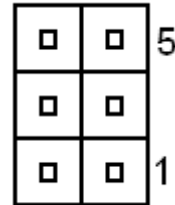
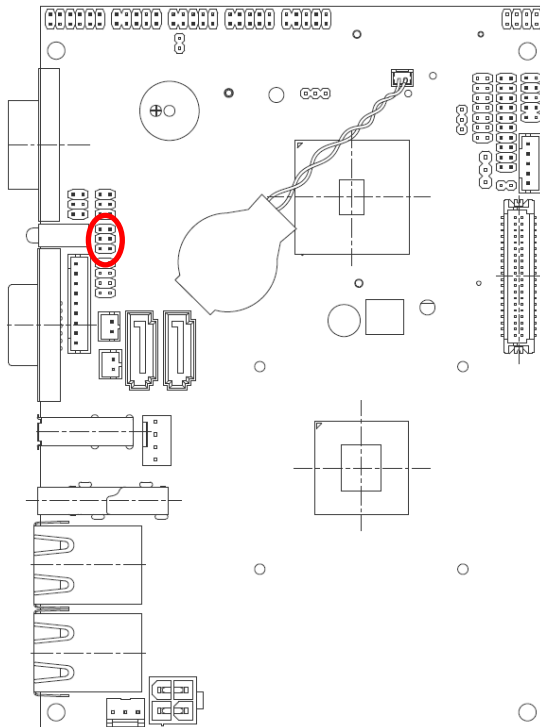

Signal	PIN	PIN	Signal
GND	6	5	+V5S
422_RXDP	4	3	485-422_TXDP
422_RXDN	2	1	485-422_TXDN

2.4.12 Audio connector (JAUDIO)

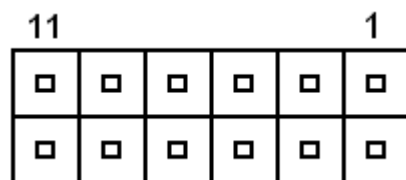
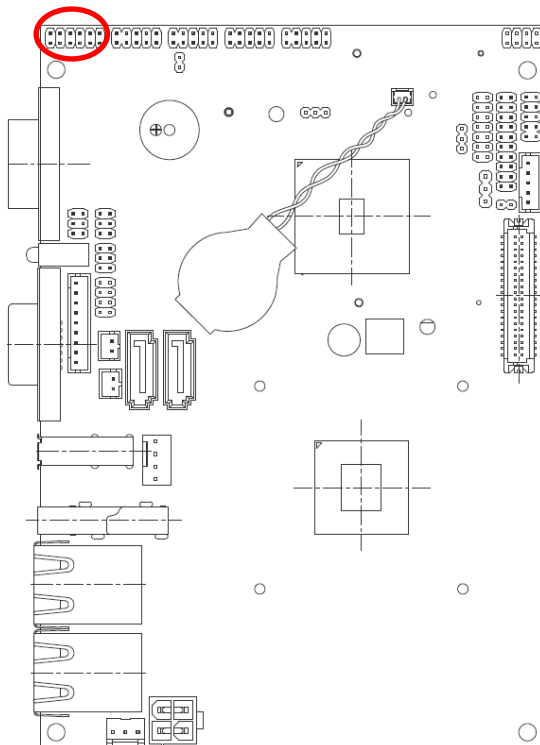

Signal	PIN	PIN	Signal
GND	12	11	MIC1_JD
LIN1_JD	10	9	FRONT_JD
MIC1_L	8	7	MIC1_R
LIN1_L	6	5	LIN1_R
GND	4	3	GND
FRONT_L	2	1	FRONT_R

2.4.13 LCD backlight brightness adjustment (JVR)

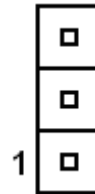
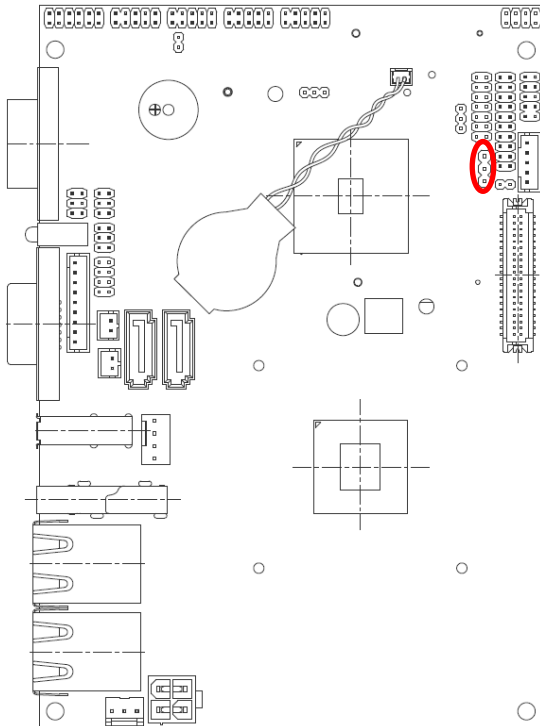

Signal	PIN
GND	3
LVDS_BKLT_CTRL	2
+5V	1

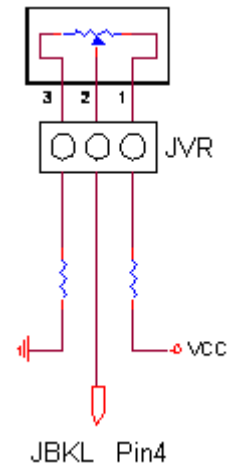

Variation Resistor

(Recommended: 4.7KΩ,
>1/16W)

2.4.14 LCD Inverter Connector (JBKL)

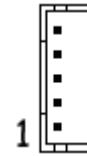
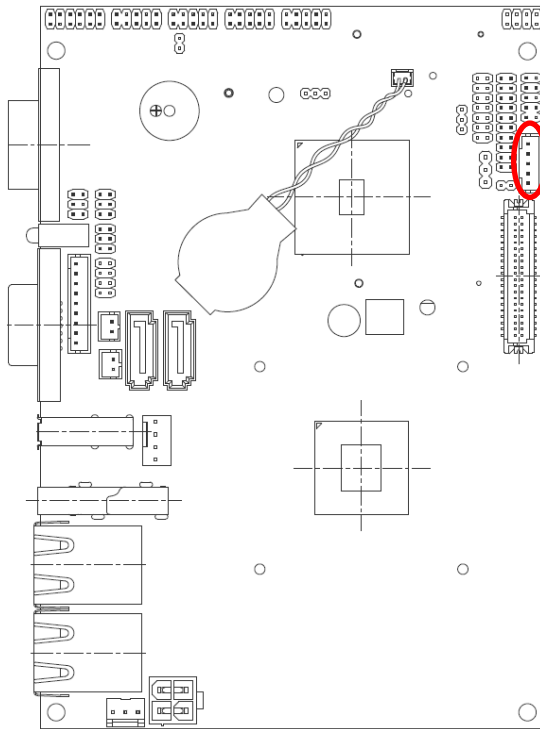

Signal	PIN
+5V	5
BRIADJ	4
BKLEN	3
GND	2
+12V	1



Note:

For inverters with adjustable Backlight function, it is possible to control the LCD brightness through the VR signal controlled by **JVR**. Please see the **JVR** section for detailed circuitry information.

2.4.14.1 Signal Description – LCD Inverter Connector (JBKL)

Signal	Signal Description
BRIADJ	Vadj = 0.75V ~ 4.25V (Recommended: 4.7KΩ, >1/16W)
BKLEN	LCD backlight ON/OFF control signal

2.4.15 Serial port 2 connector (JCOM2)

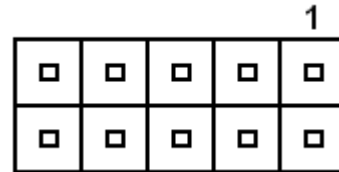
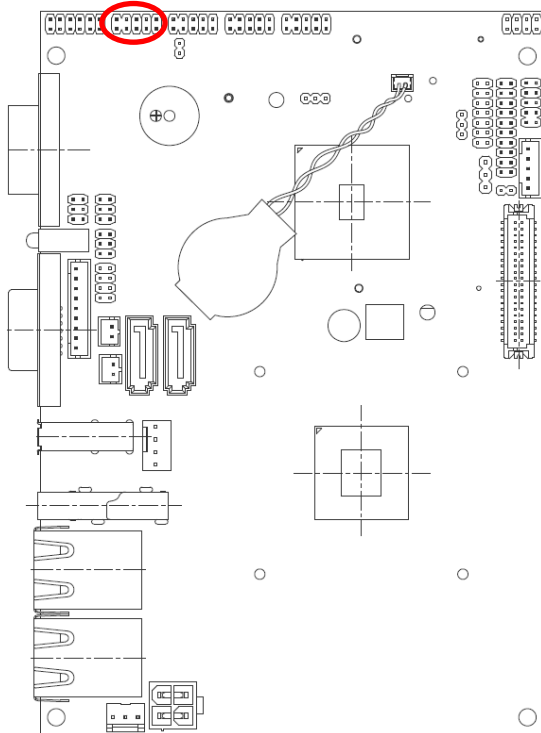

Signal	PIN	PIN	Signal
DCD	1	2	RXD
TXD	3	4	DTR
GND		6	DSR
RTS	7	8	CTS
RI2	9	10	NC

2.4.16 Touch connector (JTOUCH)

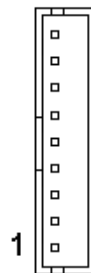
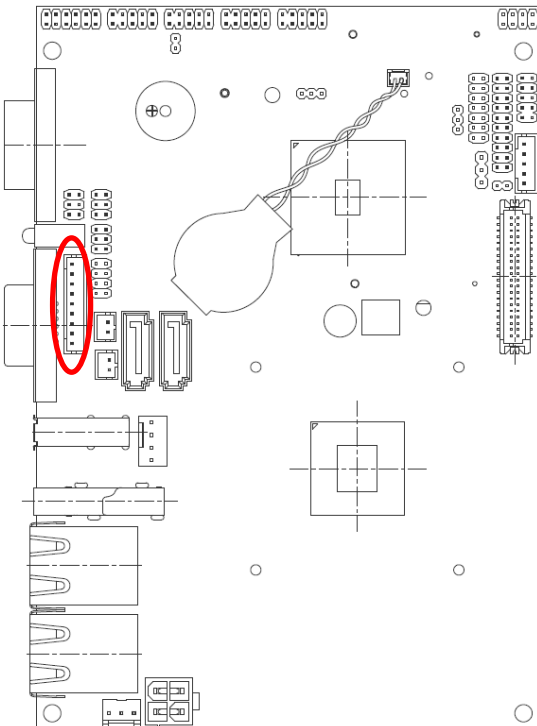

Signal	PIN	4-Wire	5-Wire	8-Wire
TGND	9	GND	GND	GND
CY-	8	Top	UL	Top Excite
CY+	7	Bottom	UR	Bottom Excite
CX-	6	Left	LL	Left Excite
CX+	5	Right	LR	Right Excite
CSENSE	4	NA	Sense	Top Sense
CY+	3	NA	NA	Bottom Sense
CX-	2	NA	NA	Left Sense
CX+	1	NA	NA	Right Sense

2.4.17 General purpose I/O connector (JDIO)

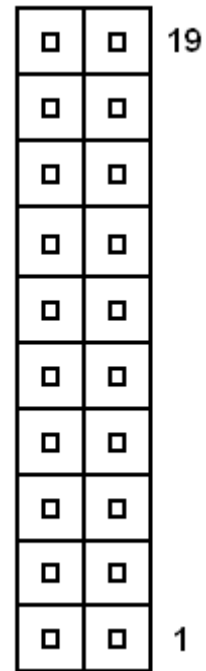
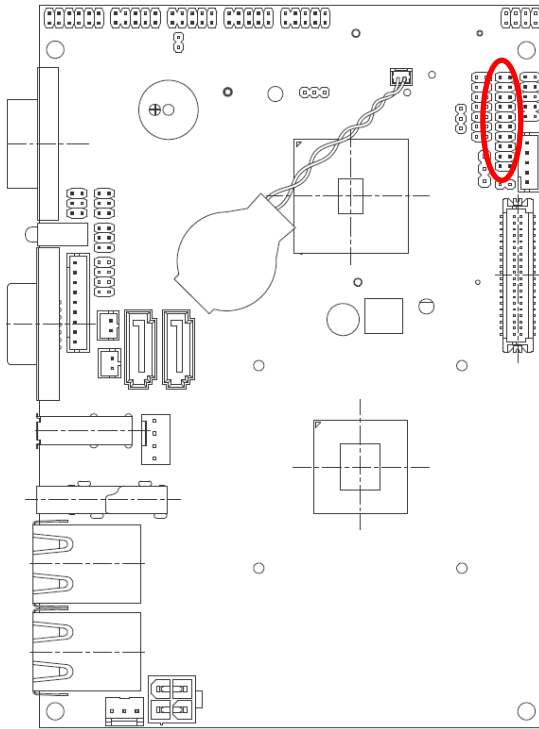

Signal	PIN	PIN	Signal
+5V	20	19	GND
SMB_DATA_S	18	17	SMB_CLK_S
GP17	16	15	GP27
GP16	14	13	GP26
GP15	12	11	GP25
GP14	10	9	GP24
GP13	8	7	GP23
GP12	6	5	GP22
GP11	4	3	GP21
GP10	2	1	GP20

2.4.18 Miscellaneous setting connector (JFP)

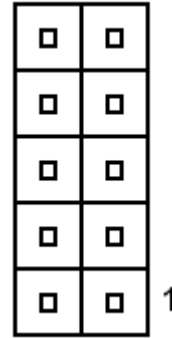
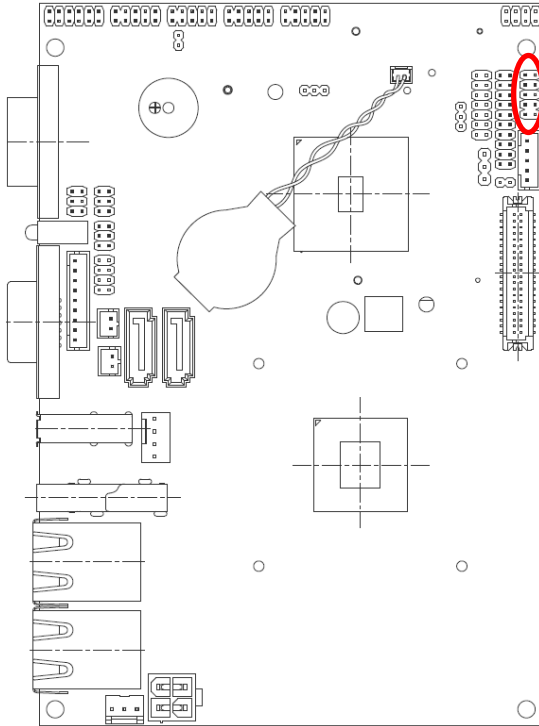

Signal	PIN	PIN	Signal
GND	10	9	CASEOPEN#
+3.3V	8	7	HD_LED#
PWR_LED#	6	5	3.3V
GND	4	3	SYS_RST#
GND	2	1	EXT_PWRBTN#

2.4.19 Keyboard & Mouse connector (JKBMS)

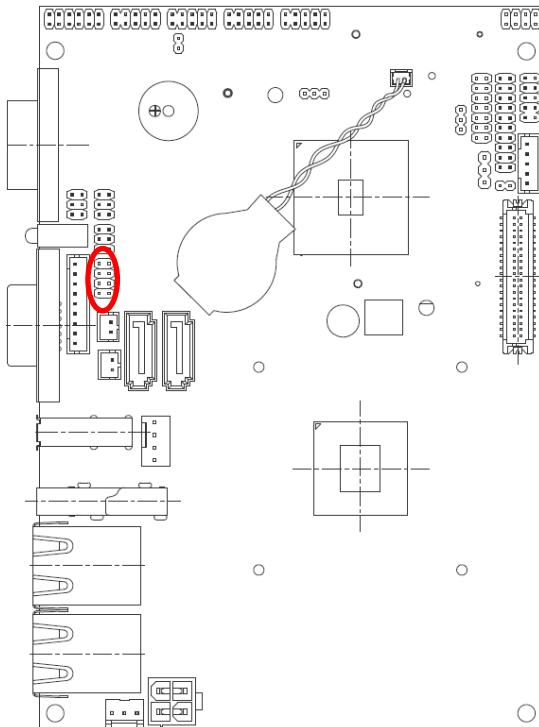

Signal	PIN	PIN	Signal
		7	NC
MS_CLK#	6	5	MS_DAT#
+VCC_KB	4	3	GND
KB_CLK#	2	1	KB_DAT#

2.4.20 Low pin count interface connector (JLPC)

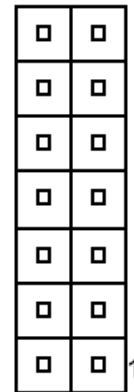
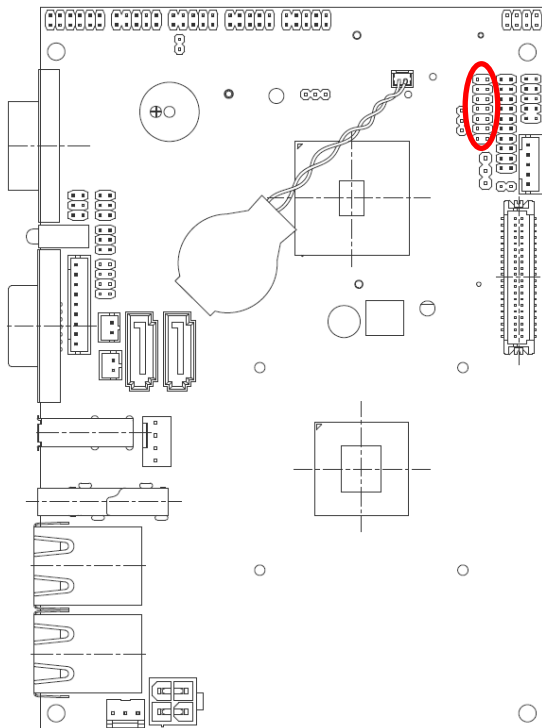

Signal	PIN	PIN	Signal
LPC_LDRQ#	14	13	+5V
GND	12	11	+5V
GND	10	9	LPC_SERIRQ
CLK_JLPC	8	7	LPC_AD3
LPC_FRAME#	6	5	LPC_AD2
A_RST#	4	3	LPC_AD1
+3.3V	2	1	LPC_AD0

2.4.21 SPI connector (JSPI)

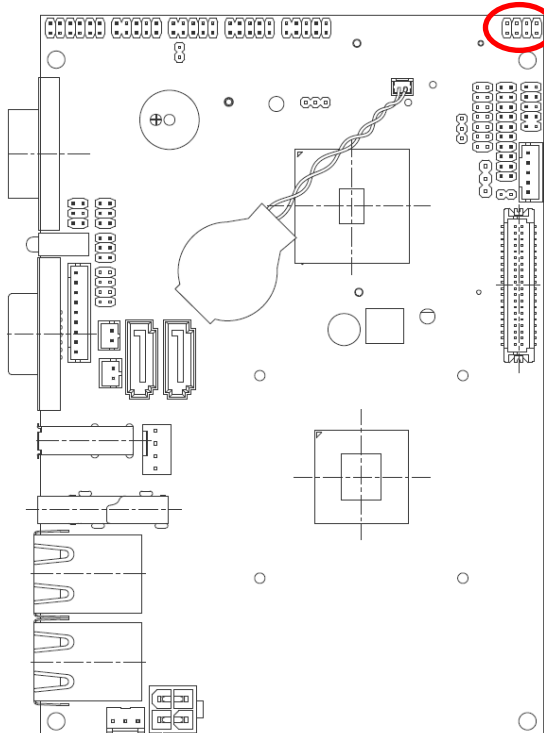

Signal	PIN	PIN	Signal
+3.3V	1	2	GND
CS#	3	4	SPI_CLK
DI_R	5	6	SPI_DO
HOLD#	7		

2.4.22 LVDS connector (JLVDS)

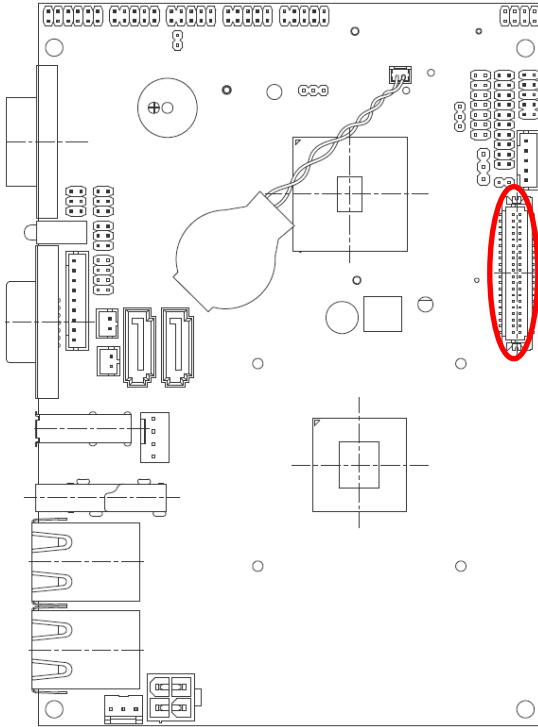

Signal	PIN	PIN	Signal
+12V	39	40	+12V
GND	37	38	GND
LVDSB_CLK#	35	36	LVDSA_CLK#
LVDSB_CLK	33	34	LVDSA_CLK
GND	31	32	GND
LVDSB_DATA3#	29	30	LVDSB_DATA2#
LVDSB_DATA3	27	28	LVDSB_DATA2
GND	25	26	GND
LVDSB_DATA1#	23	24	LVDSB_DATA0#
LVDSB_DATA1	21	22	LVDSB_DATA0
GND	19	20	GND
LVDSA_DATA3#	17	18	LVDSA_DATA2#
LVDSA_DATA3	15	16	LVDSA_DATA2
GND	13	14	GND
LVDSA_DATA1#	11	12	LVDSA_DATA0#
LVDSA_DATA1	9	10	LVDSA_DATA0
GND	7	8	GND
LVDS_DDC_CLK	5	6	LVDS_DDC_DATA
+3.3V	3	4	+5V
+3.3V	1	2	+5V

2.4.23 USB connector 0 & 1/ 4 & 5/ 2 & 3 (JUSB1/2/3)

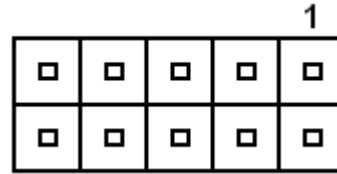
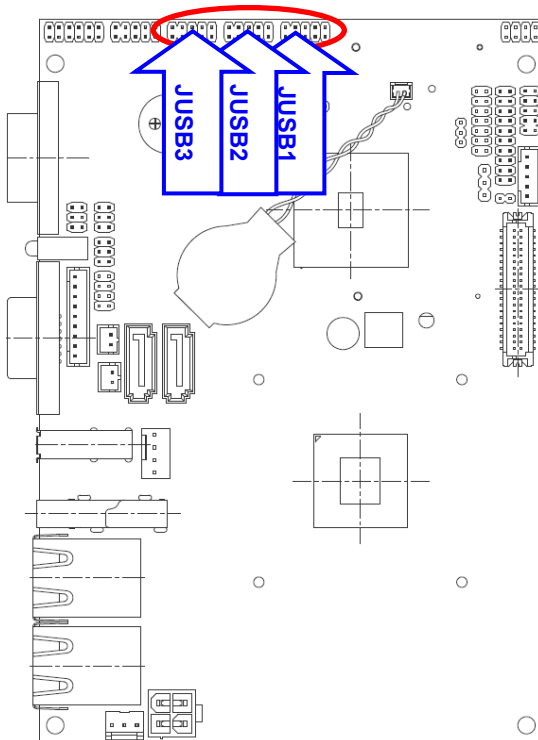

Signal	PIN	PIN	Signal
+5V	1	2	GND
N1/ N3/ N5	3	4	GND
P1/ P3/ P5	5	6	P0/ P2/P4
GND	7	8	N0/ N2/N4
GND	9	10	+5V

2.4.24 SATA1/2 Power connector (SATA1_PWR/ SATA2_PWR)

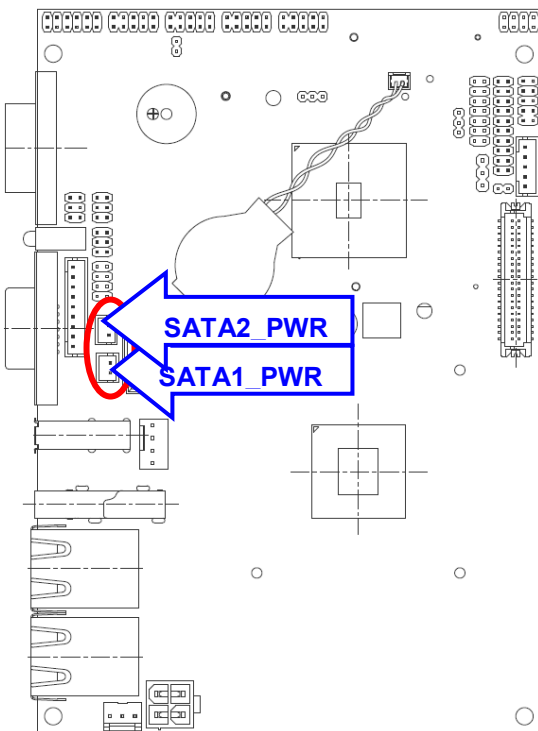

Signal	PIN
GND	1
+5V	2

3. BIOS Setup

3.1 Introduction

The BIOS setup program allows users to modify the basic system configuration. In this following chapter will describe how to access the BIOS setup program and the configuration options that may be changed.

3.2 Starting Setup

The AMI BIOS™ is immediately activated when you first power on the computer. The BIOS reads the system information contained in the CMOS and begins the process of checking out the system and configuring it. When it finishes, the BIOS will seek an operating system on one of the disks and then launch and turn control over to the operating system.

While the BIOS is in control, the Setup program can be activated in one of two ways:

By pressing immediately after switching the system on, or

By pressing the key when the following message appears briefly at the bottom of the screen during the POST (Power On Self Test).

Press DEL to enter SETUP

If the message disappears before you respond and you still wish to enter Setup, restart the system to try again by turning it OFF then ON or pressing the "RESET" button on the system case. You may also restart by simultaneously pressing <Ctrl>, <Alt>, and <Delete> keys. If you do not press the keys at the correct time and the system does not boot, an error message will be displayed and you will again be asked to.

Press F1 to Continue, DEL to enter SETUP

3.3 Using Setup

In general, you use the arrow keys to highlight items, press <Enter> to select, use the PageUp and PageDown keys to change entries, press <F1> for help and press <Esc> to quit. The following table provides more detail about how to navigate in the Setup program using the keyboard.

Button	Description
↑	Move to previous item
↓	Move to next item
←	Move to the item in the left hand
→	Move to the item in the right hand
Esc key	Main Menu -- Quit and not save changes into CMOS Status Page Setup Menu and Option Page Setup Menu -- Exit current page and return to Main Menu
PgUp key	Increase the numeric value or make changes
PgDn key	Decrease the numeric value or make changes
+ key	Increase the numeric value or make changes
- key	Decrease the numeric value or make changes
F1 key	General help, only for Status Page Setup Menu and Option Page Setup Menu
(Shift) F2 key	Change color from total 16 colors. F2 to select color forward, (Shift) F2 to select color backward
F3 key	Calendar, only for Status Page Setup Menu
F4 key	Reserved
F5 key	Restore the previous CMOS value from CMOS, only for Option Page Setup Menu
F6 key	Load the default CMOS value from BIOS default table, only for Option Page Setup Menu
F7 key	Load the default
F8 key	Reserved
F9 key	Reserved
F10 key	Save all the CMOS changes, only for Main Menu

- **Navigating Through The Menu Bar**

Use the left and right arrow keys to choose the menu you want to be in.



Note: Some of the navigation keys differ from one screen to another.

- **To Display a Sub Menu**

Use the arrow keys to move the cursor to the sub menu you want. Then press <Enter>. A “>” pointer marks all sub menus.

3.4 Getting Help

Press F1 to pop up a small help window that describes the appropriate keys to use and the possible selections for the highlighted item. To exit the Help Window press <Esc> or the F1 key again.

3.5 In Case of Problems

If, after making and saving system changes with Setup, you discover that your computer no longer is able to boot, the AMI BIOS supports an override to the CMOS settings which resets your system to its defaults.

The best advice is to only alter settings which you thoroughly understand. To this end, we strongly recommend that you avoid making any changes to the chipset defaults. These defaults have been carefully chosen by both Award and your systems manufacturer to provide the absolute maximum performance and reliability. Even a seemingly small change to the chipset setup has the potential for causing you to use the override.

3.6 BIOS setup

Once you enter the AMI BIOS CMOS Setup Utility, the Main Menu will appear on the screen. The Main Menu allows you to select from several setup functions and exit choices. Use the arrow keys to select among the items and press <Enter> to accept and enter the sub-menu.

3.6.1 Main Menu

This section allows you to record some basic hardware configurations in your computer and set the system clock.

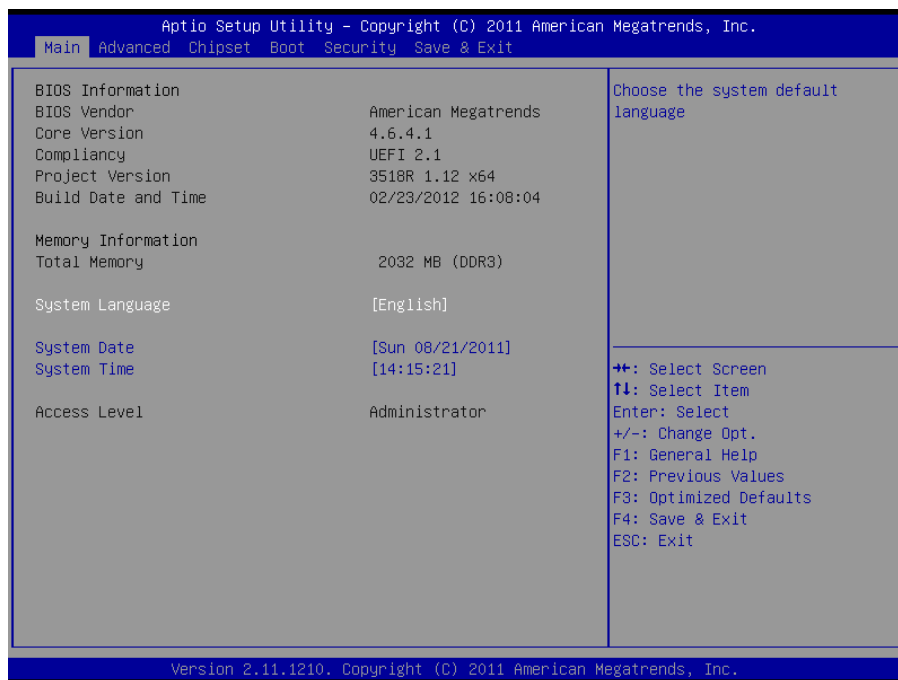

3.6.1.1 System Language

Use this option to select system language

3.6.1.2 System Date

Use the system time option to set the system time. Manually enter the hours, minutes and seconds.

3.6.1.3 System Time

Use the system Date option to set the system date. Manually enter the day, month and year.



Note: BIOS setup screens shown in this chapter are for reference only, and may not exactly match what you see on your screen. Visit the Avalue website (www.avalue.com.tw) to download the latest product and BIOS information.

3.6.2 Advanced BIOS settings

This section allows you to configure your CPU and other system devices for basic operation through the following sub-menus.

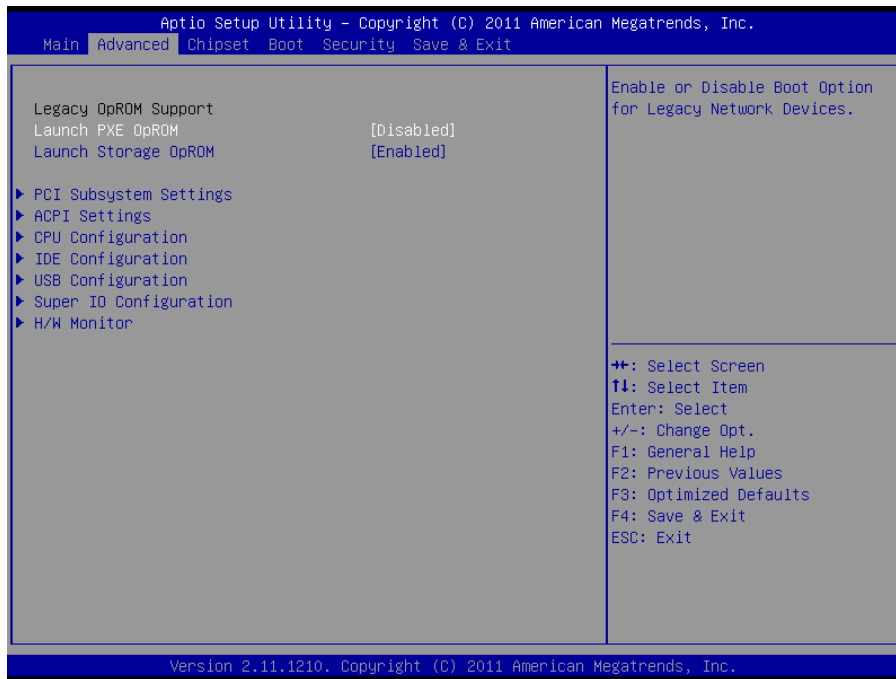

Item	Options	Description
Launch PXE OpROM	Disabled, Enabled	Enable or disable Boot Option for Legacy Network Devices
Launch Storage OpROM	Disabled, Enabled	Enable or disable Boot Option for Legacy Mass storage devices With Option ROM.

3.6.2.1 PCI Subsystem Settings

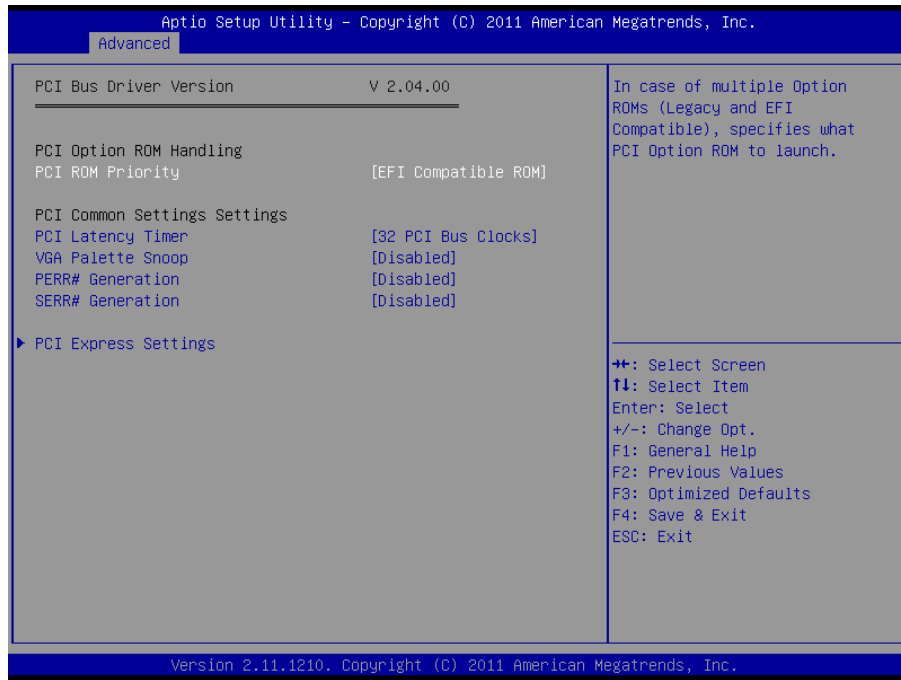

Item	Options	Description
PCI ROM Priority	Legacy ROM EFI Compatible ROM	In case of multiple Option ROMs (legacy and EFI compatible), specifies what PCI Option ROM to launch.
PCI Latency Timer	32 PCI Bus Clocks 64 PCI Bus Clocks 96 PCI Bus Clocks 128 PCI Bus Clocks 160 PCI Bus Clocks 192 PCI Bus Clocks 224 PCI Bus Clocks 248 PCI Bus Clocks	Value to be programmed into PCI Latency Timer Register.
VGA Palette Snoop	Enabled Disabled	Enables or Disables VGA Palette registers Snooping.
PERR# Generation	Enabled Disabled	Enables or Disables PCI Device to Generate PERR#
SERR# Generation	Enabled Disabled	Enables or Disables PCI Device to Generate SERR#

ECM-A50M User's Manual

3.6.2.1.1 PCI Express Settings

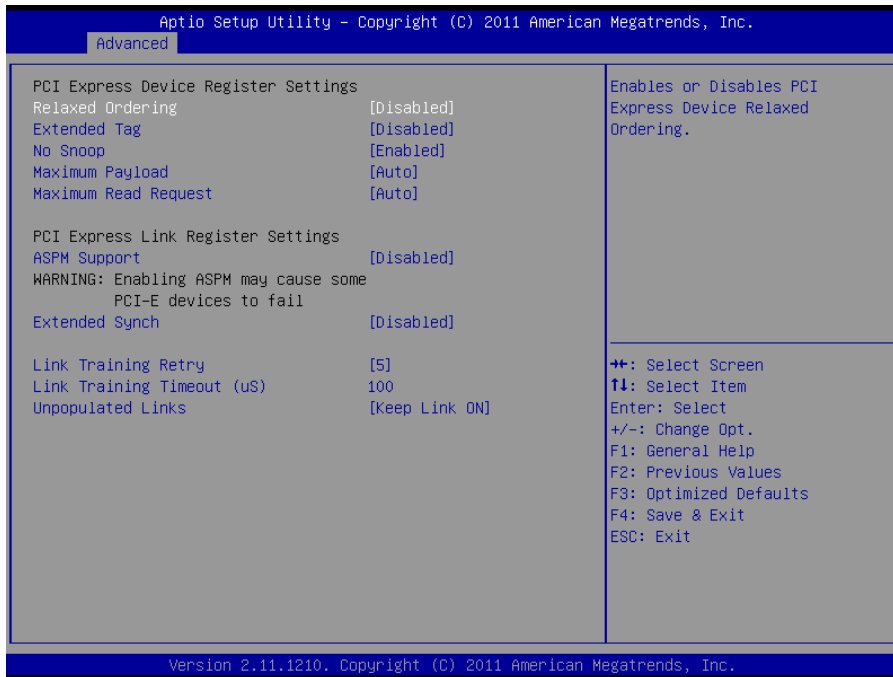

Item	Options	Description
Relaxed Ordering	Enabled Disabled	Enables or Disables PCI Express Device Relaxed ordering.
Extended Tag	Enabled Disabled	If Enabled, allows Device to use 8-bit Tag field as a requester.
No Snoop	Enabled Disabled	Enables or Disables PCI Express Device No Snoop Option.
Maximum Payload	Auto 128 bytes 256 bytes 512 bytes 1024 bytes 2048 bytes 4096 bytes	Set Maximum Payload of PCI Express Device or allow System BIOS to select the value.
Maximum Read Request	Auto 128 bytes 256 bytes 512 bytes 1024 bytes 2048 bytes 4096 bytes	Set Maximum Read Request of PCI Express Device or allow System BIOS to select the value.
ASPM Support	Force L0s Auto Disabled	Set the ASPM Level: — Force L0s - Force all links to L0s State — AUTO- BIOS auto configure: — DISABLE-Disables ASPM.
Extended Synch	Enabled Disabled	If Enabled, allows generation of Extended Synchronization patterns.

ECM-A50M User's Manual

Link Training Retry	Disabled 2 3 5	Defines number of Retry Attempts software will take to retrain the link if previous training attempt was unsuccessful.
Link Training Timeout (uS)	1~100	Defines number of Microseconds software will wait before polling "Link Training" bit in Link Status register. Value ranges from 1 to 100 uS.
Unpopulated Links	Keep Link ON Disable Link	In order to save power, software will disable unpopulated PCI Express links, if this option is set to "Disable Link"

3.6.2.2 ACPI Settings

You can use this item to set up ACPI Configuration.

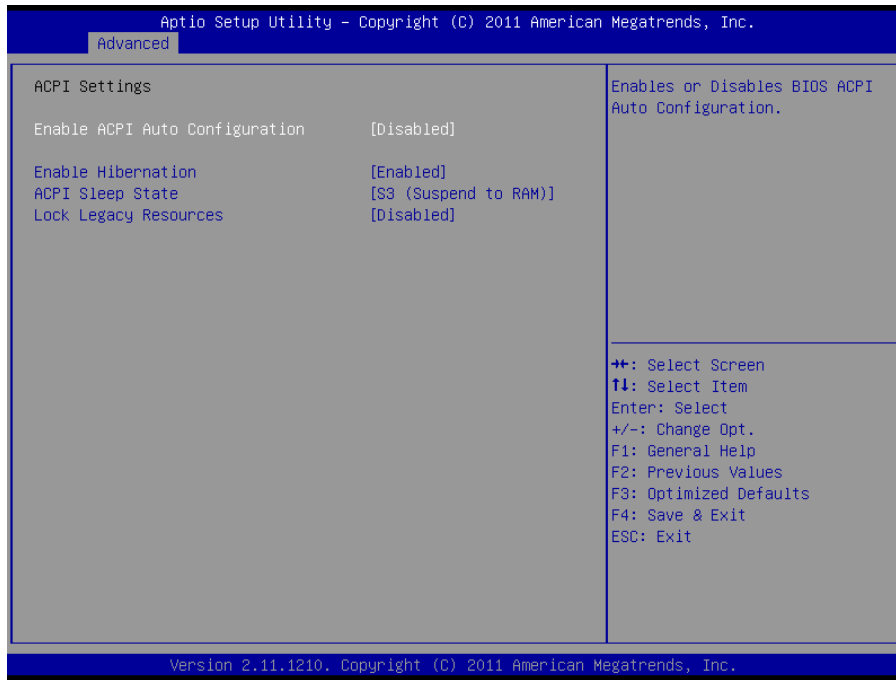

Item	Options	Description
Enable ACPI Auto Configuration	Disabled, Enabled	Enables or Disables BIOS ACPI Auto Configuration.
Enable Hibernation	Disabled, Enabled	Enables or Disables System ability to Hibernate (OS/S4 Sleep State). This option may be not effective with some OS.
ACPI Sleep State	Suspend Disabled, S3 (Suspend to RAM)	Select the highest ACPI sleep state the system will enter, when the SUSPEND button is pressed.
Lock Legacy Resources	Disabled, Enabled	Enables or Disables Lock of Legacy Resources.

3.6.2.3 CPU Configuration

Use the CPU configuration menu to view detailed CPU specification and configure the CPU.

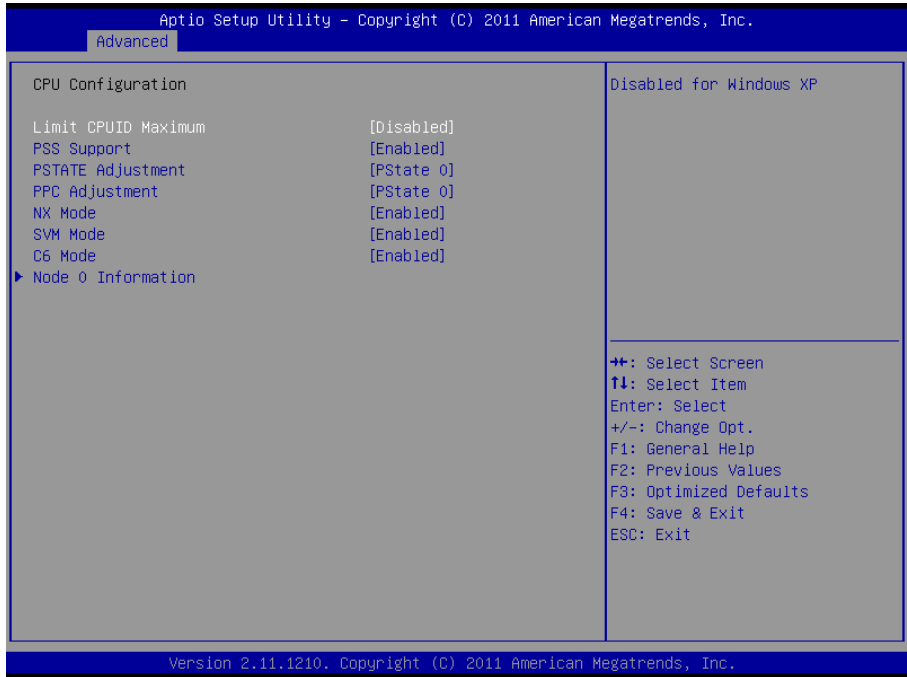

Item	Options	Description
PSS Support	Enabled Disable Link	Enable/Disable the generation of ACPI_PPC, and _PCT objects.
PSTATE Adjustment	PState 0 PState 1 PState 2 PState 3 PState 4 PState 5 PState 6 PState 7	Provided to adjust startup P-state level
PCC Adjustment	PState 0 PState 1 PState 2 PState 3 PState 4 PState 5 PState 6 PState 7	Provided to adjust _PPC object
NX Mode	Enabled Disable Link	Enable/disable No-execute page protection function.
SVM Mode	Enabled Disable Link	Enable/disable CPU Virtualisation
C6 Mode	Enabled Disable Link Auto	Enable/disable C6

ECM-A50M User's Manual

3.6.2.3.1 Node 0 Information

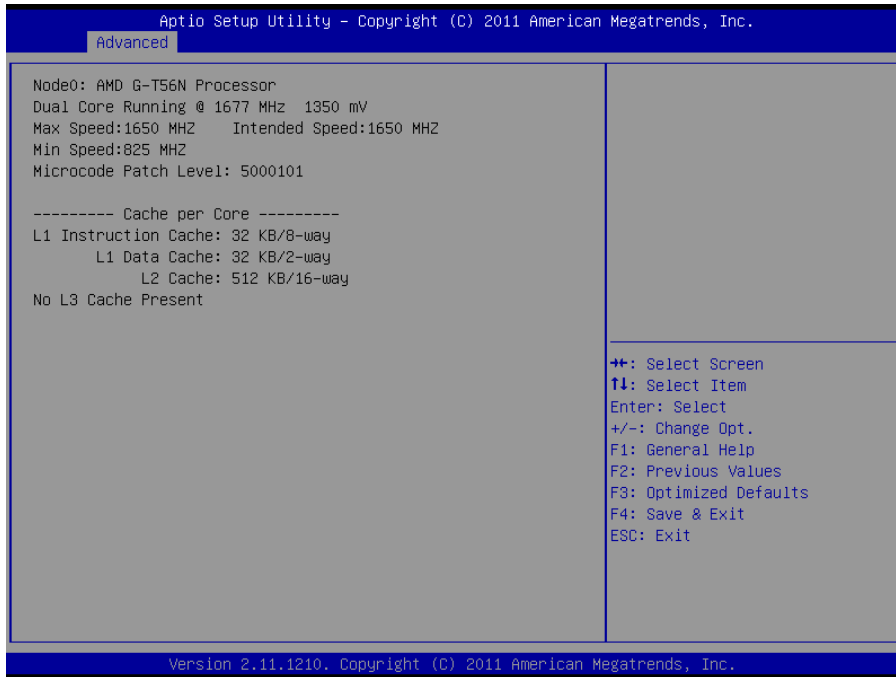

3.6.2.4 IDE Configuration

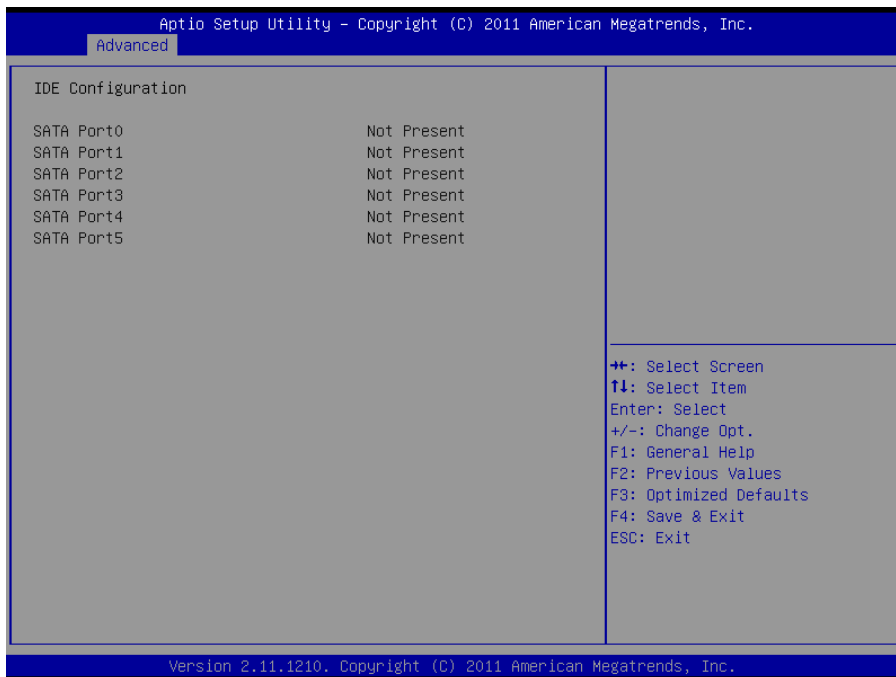

3.6.2.5 USB Configuration

The USB configuration menu is used to read USB configuration information and configure USB.

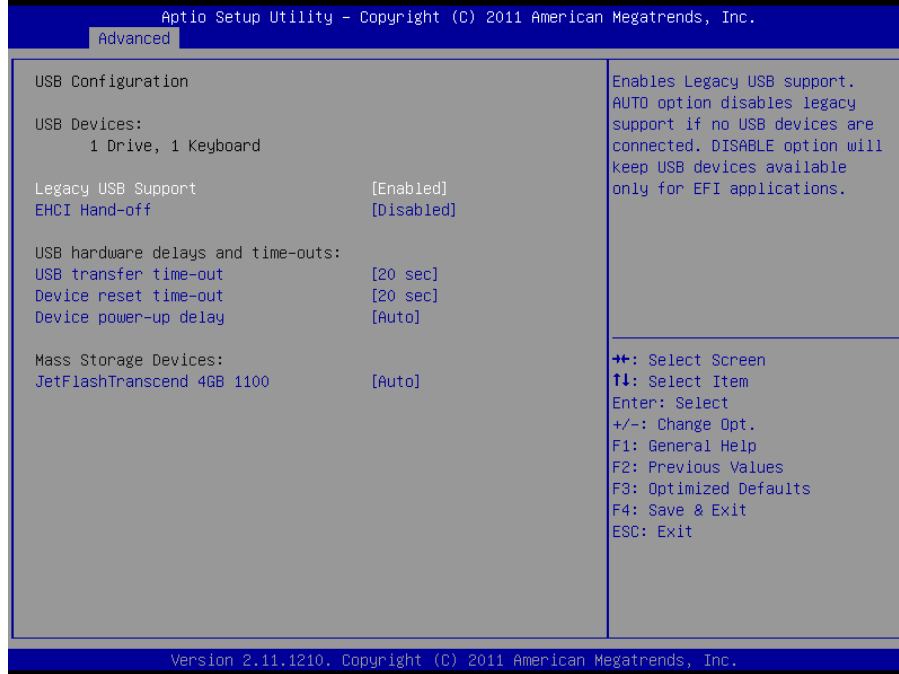

Item	Options	Description
Legacy USB support	Enabled Disabled Auto	Enables Legacy USB support. AUTO disables legacy support if no USB devices are connected. DISABLE will keep USB devices available only for EFI applications.
ECHI hand-off	Enabled Disabled	This is a workaround for OSeS without EHCI hand-off support. The EHCI ownership change should be claimed by EHCI driver.
USB transfer time-out	1sec / 5sec 10sec / 20sec	The time-out value for Control, Bulk, and Interrupt transfers.
Device reset time-out	10sec / 20sec 30sec / 40sec	USB mass storage device Start Unit command time-out.
Device power-up delay	Auto Manual	Maximum time the device will take before it properly reports itself to the Host Controller. "Auto" uses default value: for a Root port it is 100ms, for a Hub port the delay is taken from Hub descriptor.
Device power-up delay in seconds	1~40	Delay range is 1~40 seconds, in one second increments.
JetFlashTranscend 4GB 1100	Auto Floppy Forced FDD Hard-disk CD-ROM	Mass storage device emulation type. "AUTO" enumerates devices according to their media format. Optical drives are emulated as "CDROM", drives with no media will be emulated according to a drive type.

3.6.2.6 H/W Monitor

The H/W Monitor shows the operating temperature, fan speeds and system voltages.

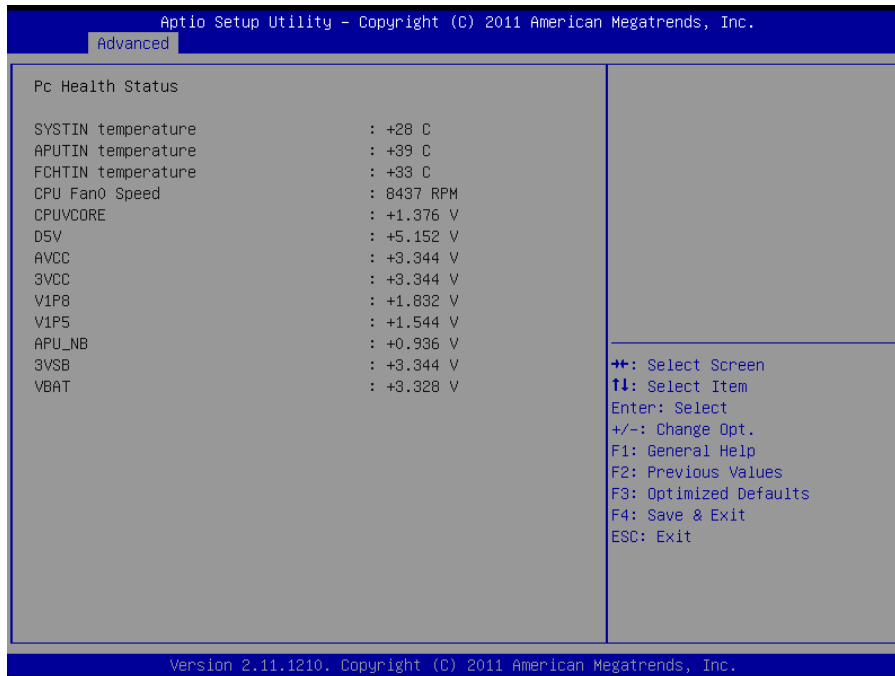

Temperature

- SYSTIN temperature
- APUTIN temperature
- FCHTIN temperature

Fan speed

- CPU Fan0 Speed

Voltage

- CPUVCORE
- D5V
- AVCC
- 3VCC
- V1P8
- V1P5
- APU_NB
- 3VSB
- APU_NB

3.6.2.7 Super IO Configuration

You can use this item to set up or change the Super IO configuration for FDD controllers, parallel ports and serial ports. Please refer to 3.6.2.7.1 and 3.6.2.7.2 for more information.



Item	Option	Description
Restore on AC Power Loss	Power Off Power On Last State	Set Restore on AC Power Loss for ATX Mode

ECM-A50M User's Manual

3.6.2.7.1 Serial Port 0 Configuration

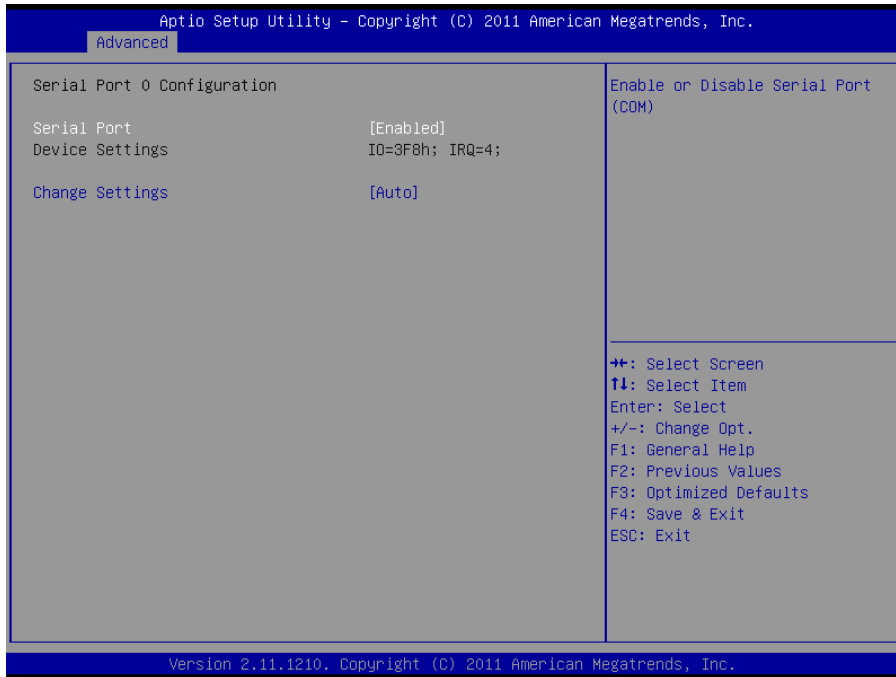

Item	Option	Description
Serial Port	Enabled, Disabled	Use the Serial port option to enable or disable the serial port.
Change Settings	Auto IO=3F8h; IRQ=4, IO=3F8h; IRQ=3,4,5,6,7,10,11,12 IO=2F8h; IRQ=3,4,5,6,7,10,11,12 IO=3E8h; IRQ=3,4,5,6,7,10,11,12 IO=2E8h; IRQ=3,4,5,6,7,10,11,12	Use the change Settings option to change the serial port IO port address and interrupt address.

ECM-A50M User's Manual

3.6.2.7.2 Serial Port 1 Configuration

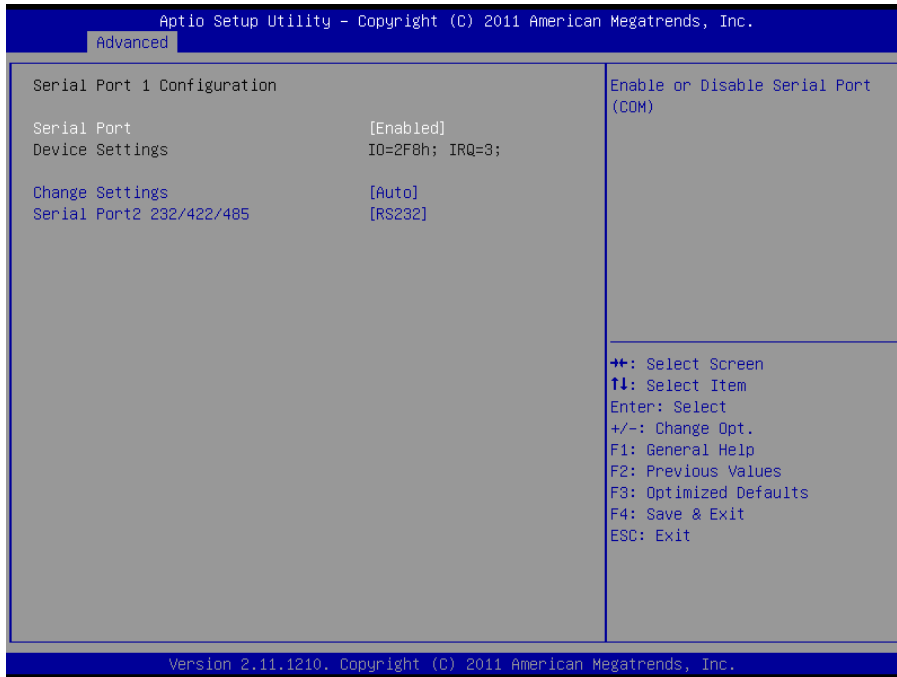

Item	Option	Description
Serial Port	Enabled, Disabled	Use the Serial port option to enable or disable the serial port.
Change Settings	Auto IO=2F8h; IRQ=3, IO=3F8h; IRQ=3,4,5,6,7,10,11,12 IO=2F8h; IRQ=3,4,5,6,7,10,11,12 IO=3E8h; IRQ=3,4,5,6,7,10,11,12 IO=2E8h; IRQ=3,4,5,6,7,10,11,12	Use the change Settings option to change the serial port IO port address and interrupt address.
Serial Port2 232/422/485	RS232, RS422, RS485	Change the Serial Port mode. Select <RS232> or <RS422><RS485> mode

3.6.3 Advanced Chipset Features



3.6.3.1 North Bridge

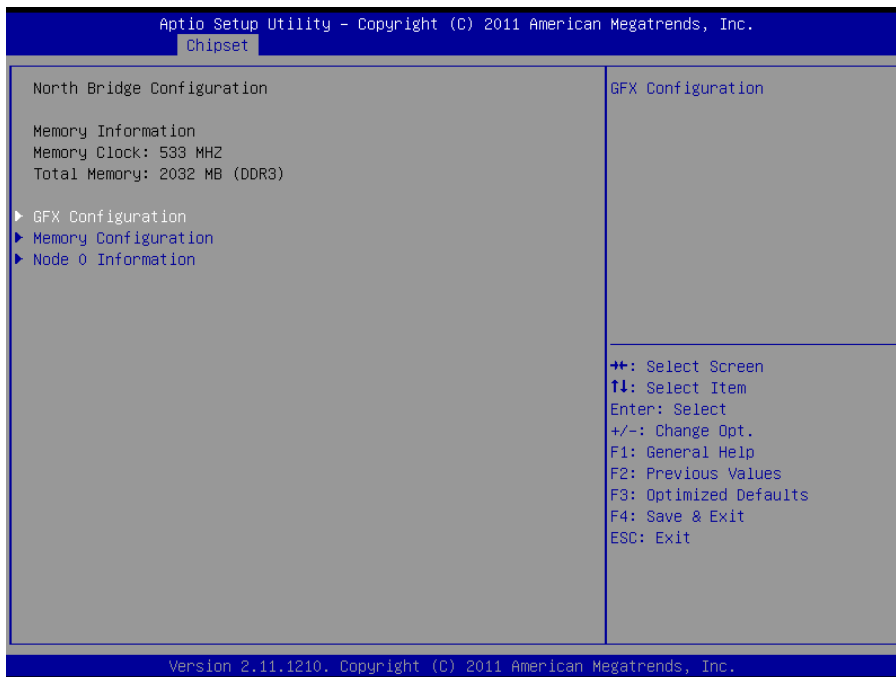

ECM-A50M User's Manual

3.6.3.1.1 GFX Configuration



Item	Option	Description
Port 4/5/6/7 Control	Enabled Disabled	Enables or disables Port 4/5/6/7 Control
ASPM Mode Control	Disabled L0s Entry L1 Entry L0s and L1 Entry	NB root port ASPM mode control
Hotplug Mode Control	Disabled Hotplug Basic Hotplug Server Hotplug Enhanced Hotplug Inboard	NB root port Hotplug mode control
Link Speed	MaxSpeed Pcie Gen1 Pcie Gen2	NB root port Pcie link speed, the link speed may be overwritten by Pssp settings.

3.6.3.1.2 Memory configuration

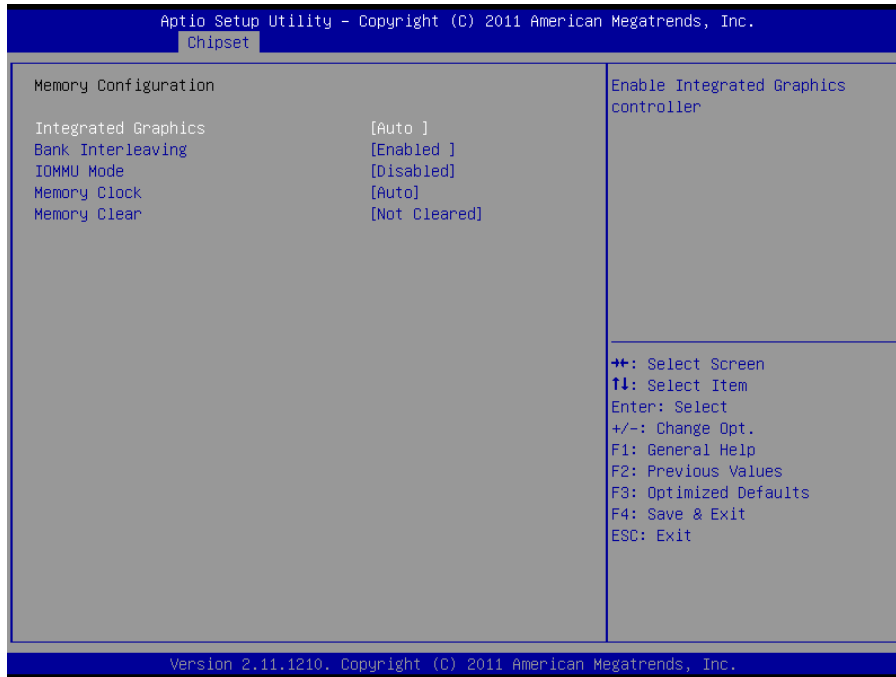

Item	Option	Description
Integrated graphics	Auto Disabled Forced	Enables Integrated Graphics controller
Bank Interleaving	Enabled Disabled	Enables or disables Bank interleaving
IOMMU Mode	Disabled 32MB 64MB 128MB 256MB 512MB 1GB 2GB	IOMMU is supported on LINUX based systems to convert 32bit I/O to 64bit MMIO.
Memory Clock	Auto 400MHz 533MHz 667MHz	This option allows User to select different Memory Clock. Default value is 400MHz.
Memory Clear	Cleared Not cleared	Memory clear functionality control

ECM-A50M User's Manual

3.6.3.1.1 Node 0 Information

View Memory Information related to Node 0

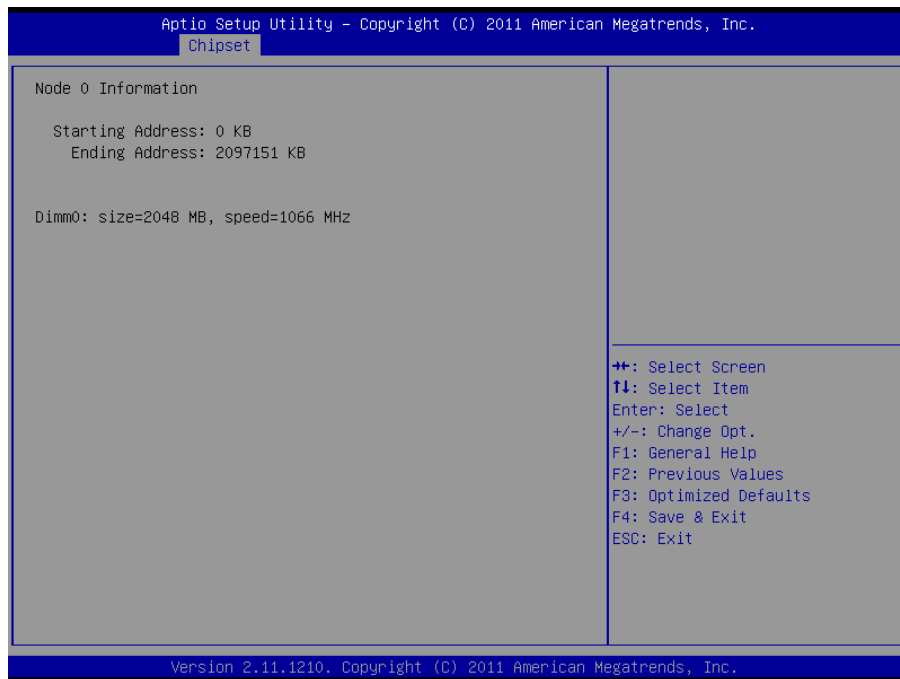

3.6.3.2 North Bridge LVDS configuration

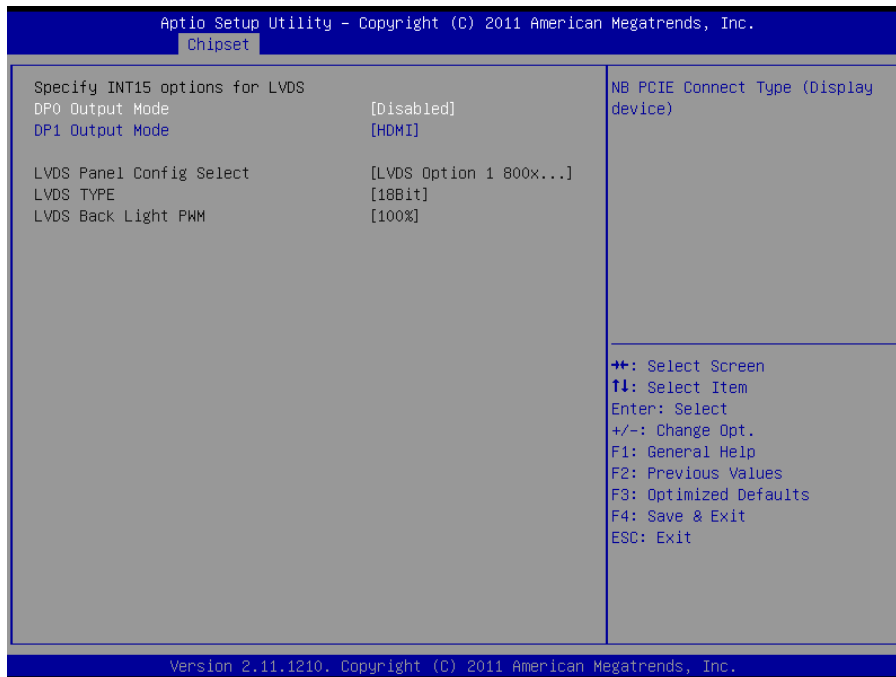

Item	Option	Description
DP0 Output Mode	Travis DP-to-LVDS Disabled	NB PCIE Connect Type (Display device)
DP1 Output Mode	HDMI Disabled	
LVDS Panel Config Select	LVDS Option 1 800x600 LVDS Option 2 1024x768 LVDS Option 3 1280x720 LVDS Option 4 1280x800 LVDS Option 5 1280x1024 LVDS Option 6 1366x768 LVDS Option 7 1440x900 LVDS Option 8 1600x900 LVDS Option 9 1920x1024	LVDS Panel Configuration
LVDS Back Light PWM	00% 25% 50% 75% 100%	Select LVDS back light PWM duty

Note:

For LVDS Back Light **PWM** to function, **LVDS** has to be chosen as Output mode in DP0.

ECM-A50M User's Manual

3.6.3.3 South Bridge

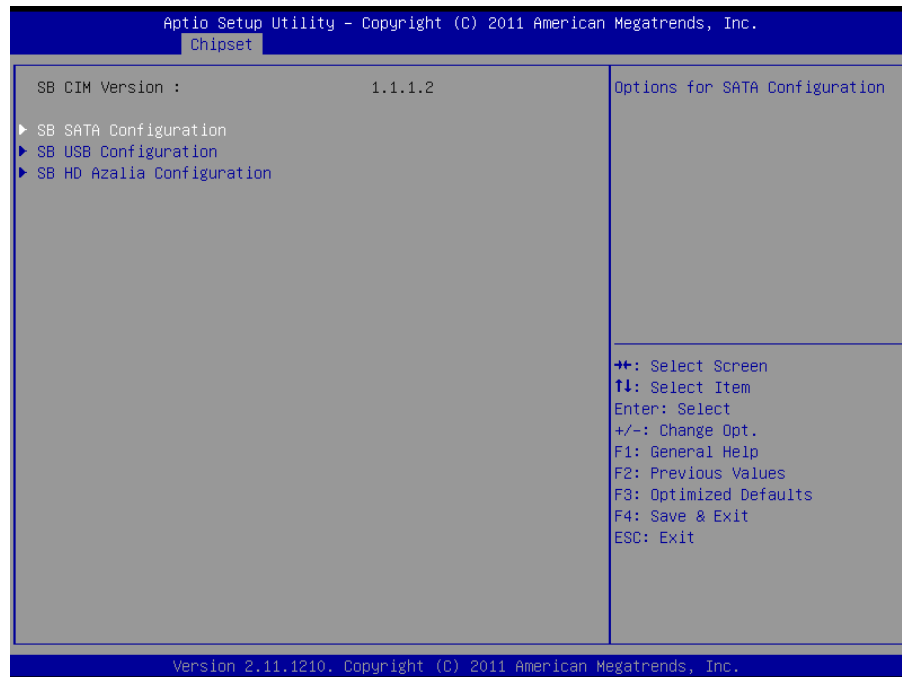

ECM-A50M User's Manual

3.6.3.3.1 SB SATA Configuration

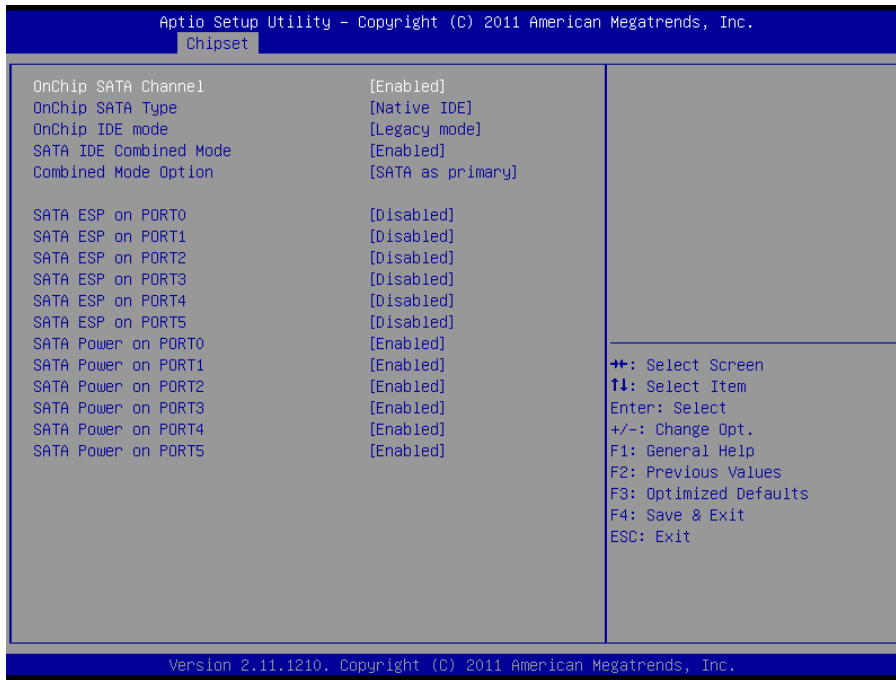

Item	Option	Description
OnChip SATA Type	Native IDE AHCI Legacy IDE	Native IDE /n RAID /n AHCI /n AHCI / n Legacy IDE /n IDE → AHCI /n HyperFlash.
SATA Force Raid	No Function Force Raid	No function: Raid 5 Force Raid: Raid 0/1
OnChip IDE mode	Legacy Mode Native Mode	Options for OnChip IDE mode
SATA IDE Combined Mode	Enabled Disabled	Enables or disables SATA IDE Combined Mode
Combined Mode Option	SATA as primary SATA as secondary	Settings for combined Mode Option
SATA ESP on PORT0/1/2/3/4/5	Enabled Disabled	Enables or disables SATA ESP on PORT0/1/2/3/4/5
SATA Power on PORT0/1/2/3/4/5	Enabled Power down	Settings for SATA Power on PORT0/1/2/3/4/5

ECM-A50M User's Manual

3.6.3.3.2 SB USB Configuration

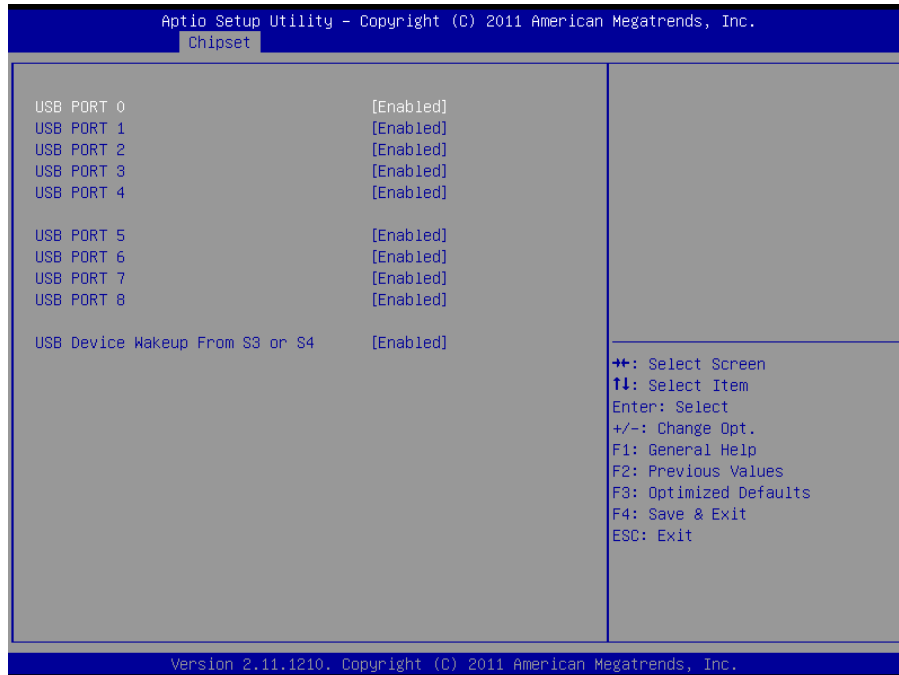

Item	Option	Description
USB PORT 0/1/2/3/4/5/6/7/8	Enabled Disabled	Enables or disables USB PORT 0/1/2/3/4/5/6/7/8
USB Device Wakeup From S3 or S4	Enabled Disabled	Enables or disables USB Device Wakeup From S3 or S4

3.6.3.3.3 SB HD Azalia Configuration

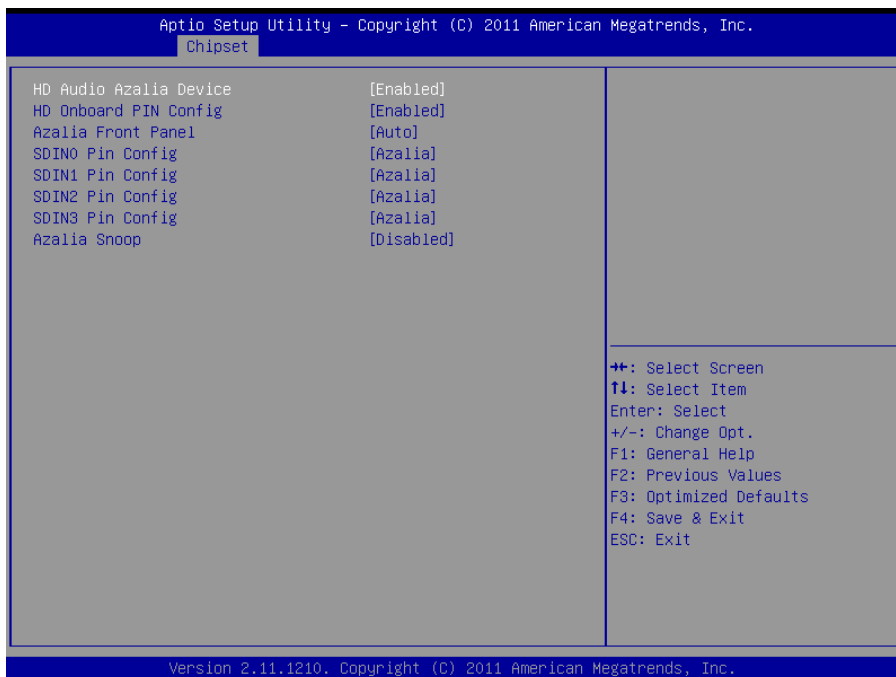

ECM-A50M User's Manual

Item	Option	Description
HD Audio Azalia Device	Auto Enabled Disabled	HD Audio Azalia Device Configuration
HD Onboard PIN Config	Enabled Disabled	HD Onboard PIN Configuration
Azalia Front Panel	Auto Disabled	Azalia Front Panel Configuration
SDIN0/1/2/3 Pin Config	GPIO Azalia	SDIN0/1/2/3 Pin Configuration
Azalia Snoop	Enabled Disabled	Azalia Snoop Configuration

3.6.4 Boot

Use Boot menu to set system boot options.



Item	Option	Description
Setup Prompt Timeout	1~65535	Number of seconds to wait for setup activation key. 65535(0xFFFF) means indefinite waiting.
Bootup NumLock State	On Off	Select the keyboard NumLock state
Quiet Boot	Enabled Disabled	Enables or Disables Quiet Boot Option
Fast Boot	Enabled Disabled	Enables or Disables boot with initialization of a minimal set of devices required to launch active boot option. Has no effect for BBS boot options

GateA20 Active	Upon request Always	UPON REQUEST –GA20 can be disabled using BIOS services. ALWAYS- do not allow disabling GA20; this option is useful when any RT code is executed above 1MB
Option ROM Messages	Force BIOS Keep current	Set display mode for Option ROM
Interrupt 19 Capture	Enabled Disabled	Enabled: allows Option ROMs to trap Int 19
Boot Option #1/2	Sets the system boot order	

3.6.5 Security

Use the Security menu to set system and user password.



3.6.5.1 Administrator Password

This setting specifies a password that must be entered to access the BIOS Setup Utility. If only the Administrator's password is set, then this only limits access to the BIOS setup program and is only asked for when entering the BIOS setup program. By default, no password is specified.

3.6.5.2 User Password

This setting specifies a password that must be entered to access the BIOS Setup Utility or to boot the system. If only the User's password is set, then this is a power on password and must be entered to boot or enter the BIOS setup program. In the BIOS setup program, the User will have Administrator rights. By default, no password is specified.

3.6.6 Save & Exit

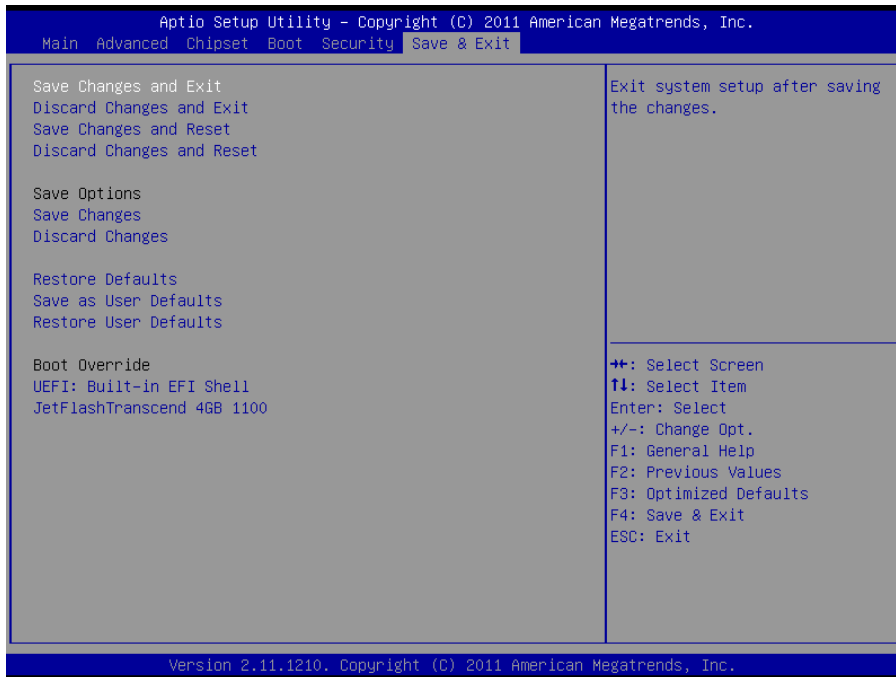

3.6.6.1 Save Changes and Exit

Use the save changes and reset option to save the changes made to the BIOS options and to exit the BIOS configuration setup program.

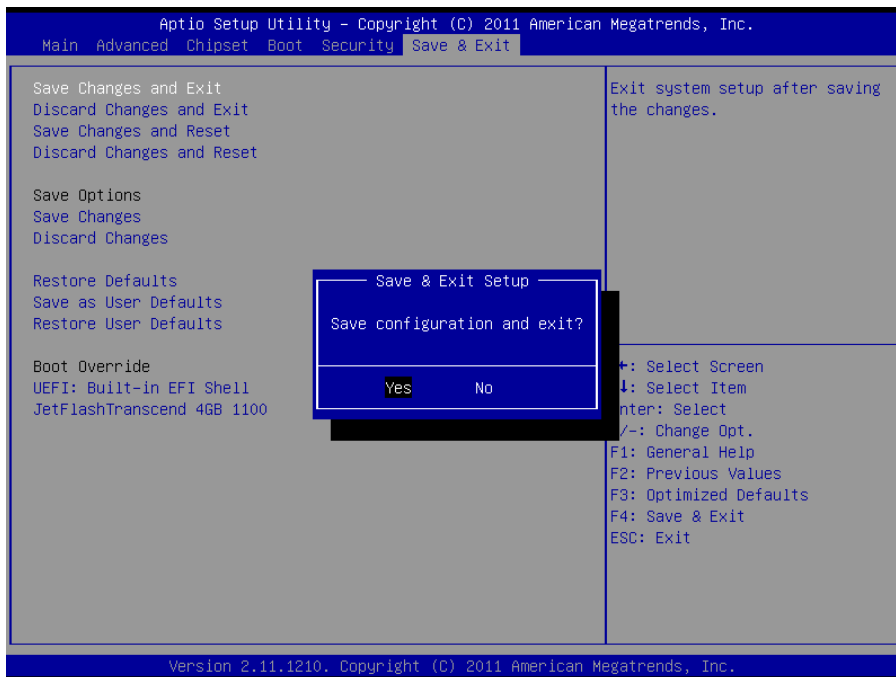

3.6.6.2 Discard Changes and Exit

Use the Discard changes and Exit option to exit the system without saving the changes made to the BIOS configuration setup program.

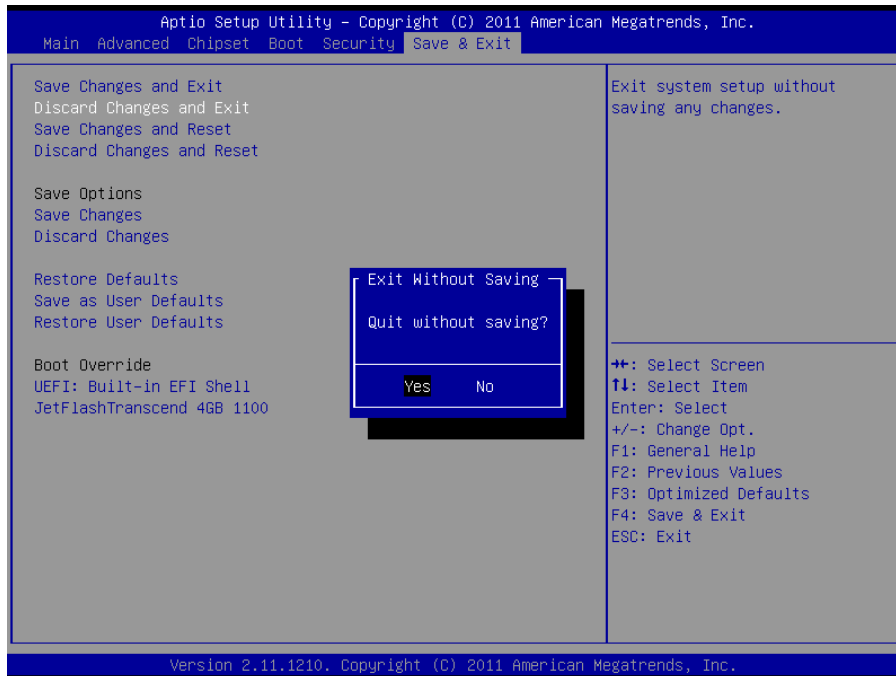

3.6.6.3 Save Changes and Reset

Any changes made to BIOS settings are stored in NVRAM. The setup program then exits and reboots the controller.

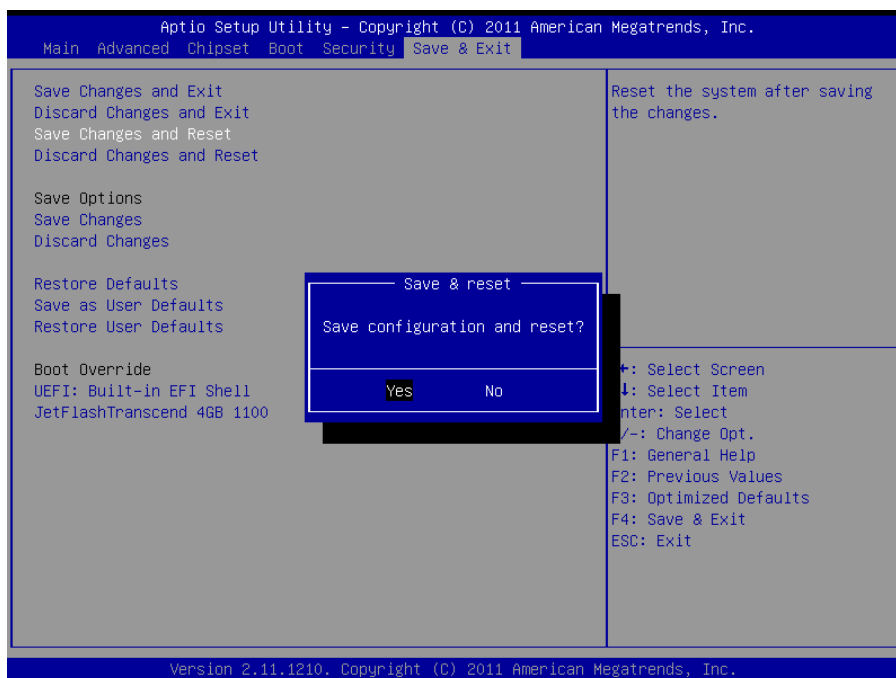

3.6.6.4 Discard Changes and Reset

Any changes made to BIOS settings during this session of the BIOS setup program are discarded. The setup program then exits and reboots the controller.

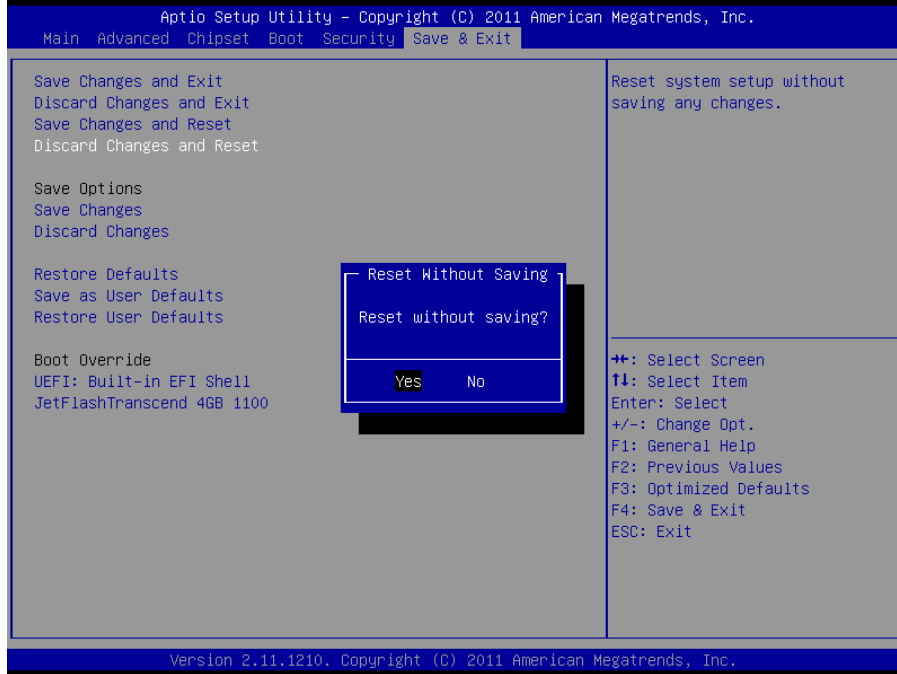

3.6.6.5 Save Changes

Changes made to BIOS settings during this session are committed to NVRAM. The setup program remains active, allowing further changes.

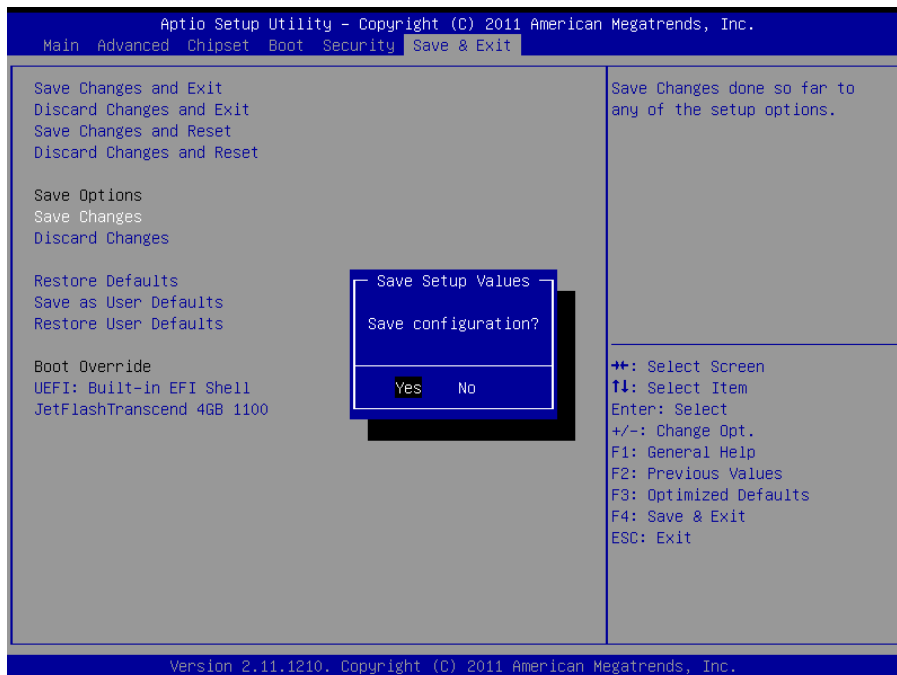

3.6.6.6 Discard Changes

Any changes made to BIOS settings during this session of the BIOS setup program are discarded. The BIOS setup continues to be active.



3.6.6.7 Restore Defaults

This option restores all BIOS settings to the factory default. This option is useful if the controller exhibits unpredictable behavior due to an incorrect or inappropriate BIOS setting.



3.6.6.8 Save as user defaults

This option saves a copy of the current BIOS settings as the User Defaults. This option is useful for preserving custom BIOS setup configurations.



3.6.6.9 Restore as user defaults

This option restores all BIOS settings to the user defaults. This option is useful for restoring previously preserved custom BIOS setup configurations.



3.6.6.10 Boot override

This option lists all possible bootable devices and allows the user to override the **Boot Option Priorities** list for the current boot. If no changes have been made to the BIOS setup options, the system will continue booting to the selected device without first rebooting. If BIOS setup options have been changed and saved, a reboot will be required and the boot override selection will not be valid.

4. Drivers Installation



Note: Installation procedures and screen shots in this section are for your reference and may not be exactly the same as shown on your screen.

4.1 Install Audio Driver (For Realtek ALC892)

Insert the Supporting CD-ROM to CD-ROM drive, and it should show the index page of Avalue's products automatically. If not, locate Index.htm and choose the product from the menu left,.



Note: The installation procedures and screen shots in this section are based on Windows 2000 operation system.

Step 1. Locate 「\Audio\Realtek\ALC892\setup.exe」.

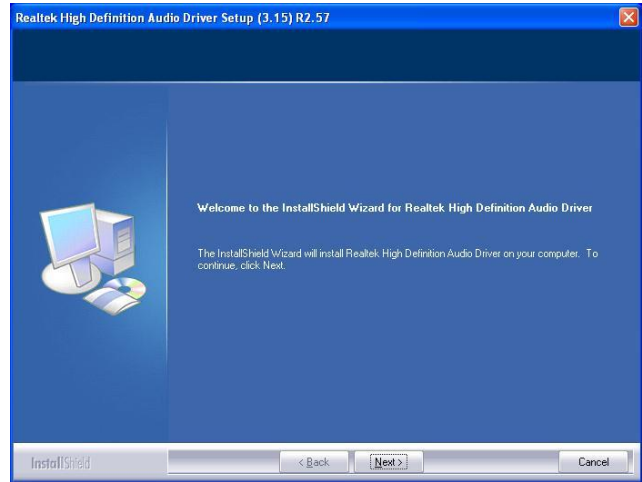

Step 2. Select **Next** to the next step.

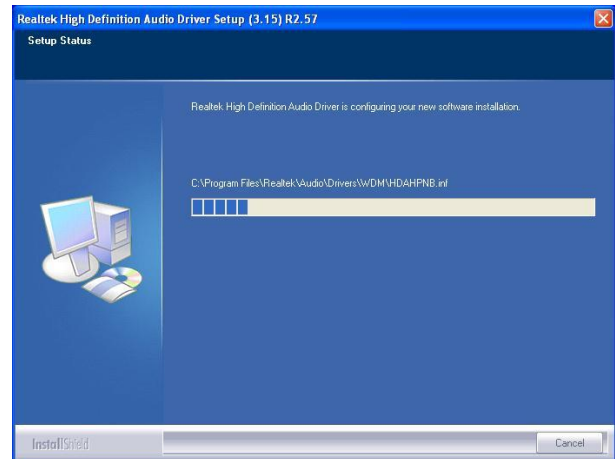

Step 3. Select **Next** to the next step.

4.2 Install Ethernet Driver (For Realtek 8111E)

Insert the Supporting DVD-ROM to DVD-ROM drive, and it should show the index page of Avalue's products automatically. If not, locate Index.htm and choose the product from the menu left.



Note: The installation procedures and screen shots in this section are based on Windows XP operation system.

Step 1. Locate 「Realtek\8111E」 and choose your system OS.

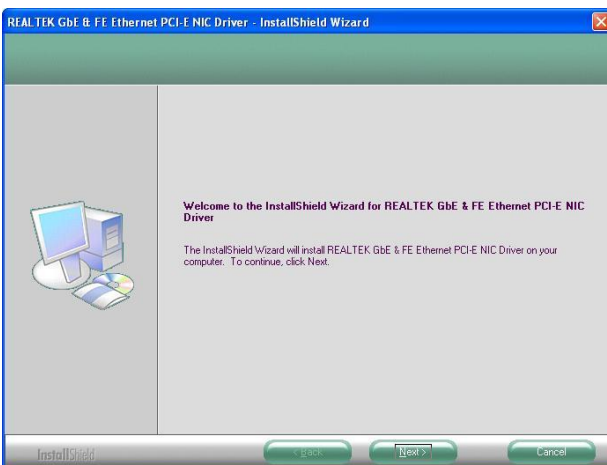

Step 2. Click **Next**.

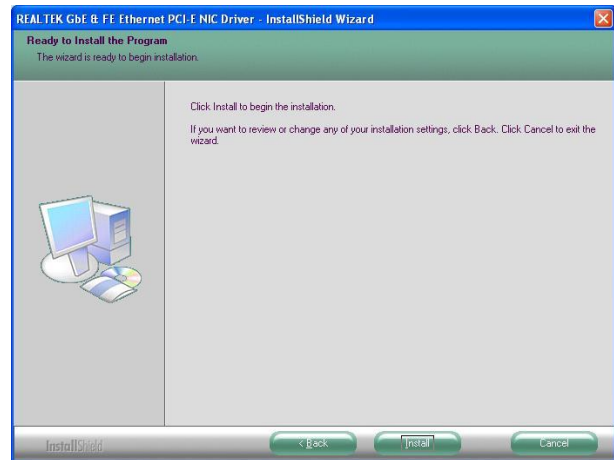

Step 3. Click **Install** to run the installation.

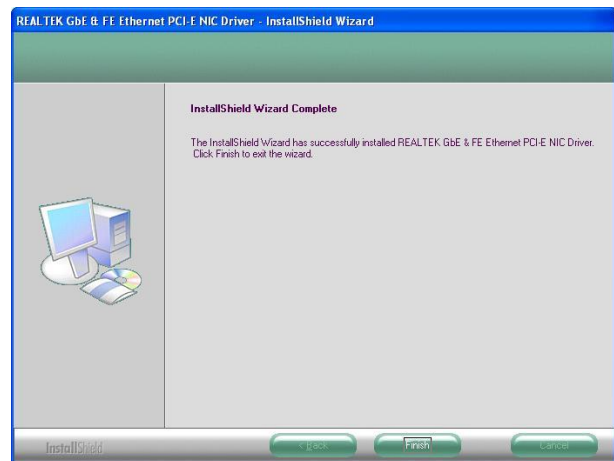

Step 4. Click **Finish** to complete installation

4.3 Install Display Driver (For AMD Fusion Accelerated Processors)

Insert the Supporting DVD-ROM to DVD-ROM drive, and it should show the index page of Avalue's products automatically. If not, locate Index.htm and choose the product from the menu left.



Note: The installation procedures and screen shots in this section are based on Windows XP operation system.

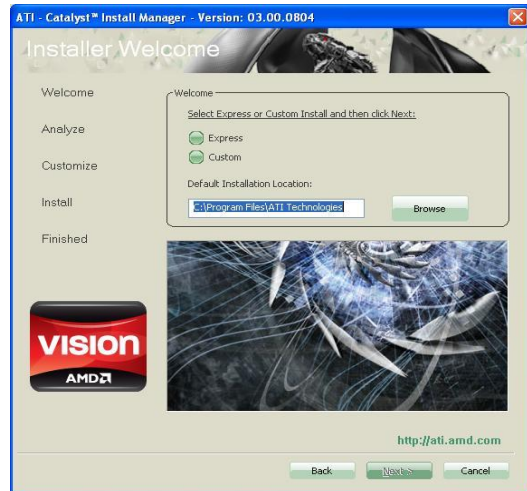

Step 4. Click Next.

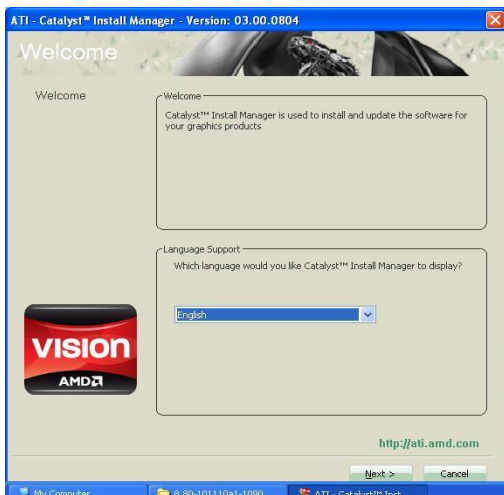

Step 2. Choose language, Click Next.

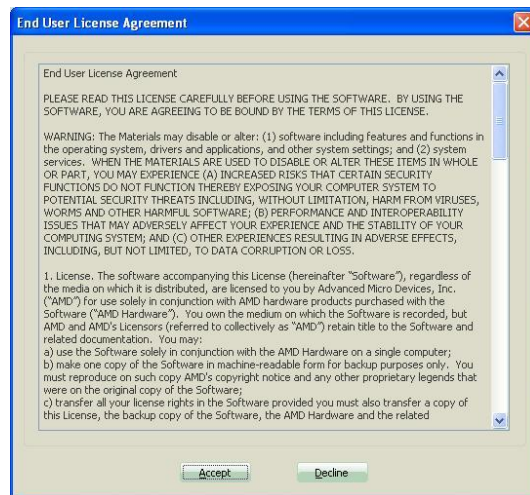

Step 5. Click Accept to continue setup.

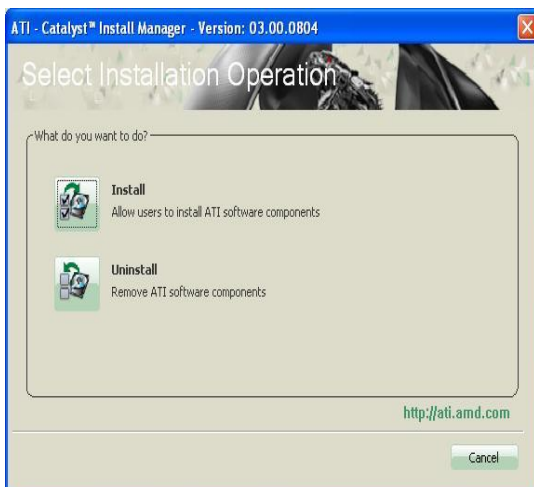

Step 3. Click Install to begin installation.

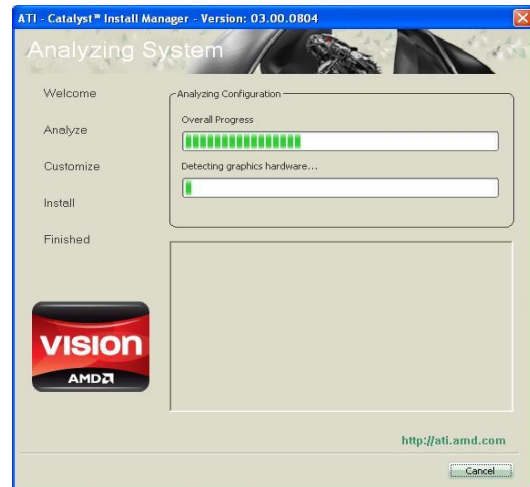

Step 6. Installing.

5. Mechanical Drawing

ECM-A50M User's Manual

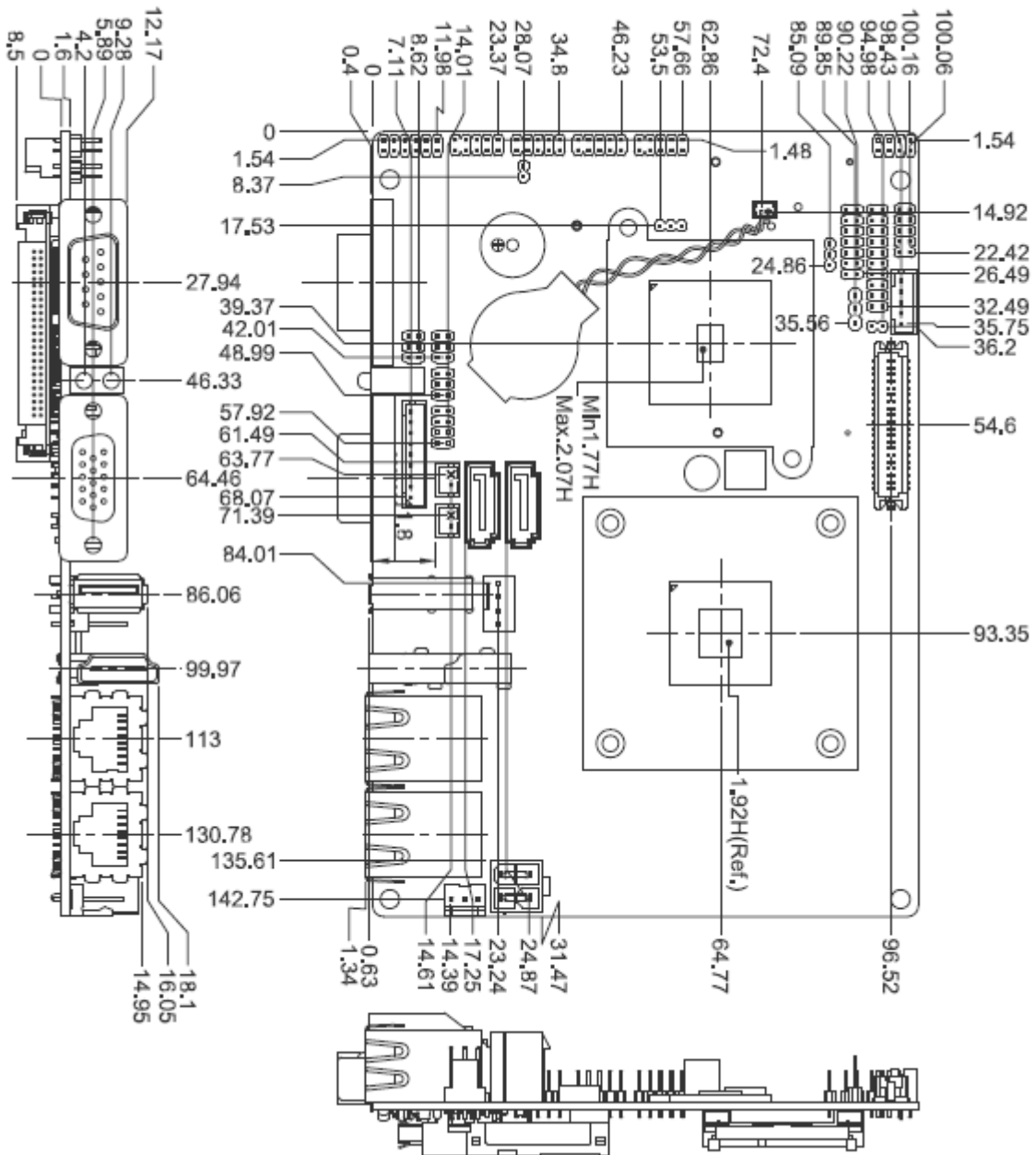

Unit: mm

DATA MODUL

DISPLAYS AND EMBEDDED SOLUTIONS



DATA MODUL Headquarters Munich

Landsberger Str. 322
D-80687 Munich - Germany
Phone: +49-89-56017-0
Fax: +49-89-56017-119
www.data-modul.com

Sales Office Hamburg

Borsteler Chaussee 51
D-22453 Hamburg - Germany
Phone: +49-40-42947377-0

Sales Office Duesseldorf

Fritz-Vomfelde-Str. 8
D-40547 Duesseldorf - Germany
Phone: +49-211-52709-0

Sales Office Scandinavia

Lundsmіндеvej 5
DK-6000 Kolding - Denmark
Phone: +45-75-224477

DATA MODUL France, S.A.R.L.

Bat B – Hall 204
1-3 Rue des Campanules
F-77185 Lognes - France
Phone: +33-1-60378100

DATA MODUL Italy, S.r.l.

Regus Center Senigallia
Via Senigallia 18/2
I-20161 Milano - Italy
Phone: +39-02-64672509

DATA MODUL Iberia, S.L.

c/ Adolfo Pérez Esquivel 3
Edificio Las Americas III Oficina 40
28230 Parque Empresarial
Las Rozas / Madrid - Spain
Phone: +34-916-366458

DATA MODUL Suisse GmbH

Stationsstr. 57
CH-8606 Nänikon - Switzerland
Phone: +41-44-94091-50

DATA MODUL Ltd. / UK

Collins Building
3 Vigo Place - Aldridge - Walsall
WS9 8UG - United Kingdom
Phone: +44-121-6988641

DATA MODUL Inc. / USA

275 Marcus Blvd, Unit K
Hauppauge, NY 11788 - USA
Phone: +1-631-951-0800