

ECM-SKLH

Intel® Skylake H Processor 3.5" Micro Module

User's Manual

2nd Ed – 02 November 2016

FCC Statement



THIS DEVICE COMPLIES WITH PART 15 FCC RULES. OPERATION IS SUBJECT TO THE FOLLOWING TWO CONDITIONS:

- (1) THIS DEVICE MAY NOT CAUSE HARMFUL INTERFERENCE.
- (2) THIS DEVICE MUST ACCEPT ANY INTERFERENCE RECEIVED INCLUDING INTERFERENCE THAT MAY CAUSE UNDESIRE OPERATION.

THIS EQUIPMENT HAS BEEN TESTED AND FOUND TO COMPLY WITH THE LIMITS FOR A CLASS "A" DIGITAL DEVICE, PURSUANT TO PART 15 OF THE FCC RULES.

THESE LIMITS ARE DESIGNED TO PROVIDE REASONABLE PROTECTION AGAINST HARMFUL INTERFERENCE WHEN THE EQUIPMENT IS OPERATED IN A COMMERCIAL ENVIRONMENT. THIS EQUIPMENT GENERATES, USES, AND CAN RADIATE RADIO FREQUENCY ENERGY AND, IF NOT INSTALLED AND USED IN ACCORDANCE WITH THE INSTRUCTION MANUAL, MAY CAUSE HARMFUL INTERFERENCE TO RADIO COMMUNICATIONS.

OPERATION OF THIS EQUIPMENT IN A RESIDENTIAL AREA IS LIKELY TO CAUSE HARMFUL INTERFERENCE IN WHICH CASE THE USER WILL BE REQUIRED TO CORRECT THE INTERFERENCE AT HIS OWN EXPENSE.

Notice

This guide is designed for experienced users to setup the system within the shortest time. For detailed information, please always refer to the electronic user's manual.

Copyright Notice

Copyright © 2016 Avalue Technology Inc., ALL RIGHTS RESERVED.

No part of this document may be reproduced, copied, translated, or transmitted in any form or by any means, electronic or mechanical, for any purpose, without the prior written permission of the original manufacturer.

Trademark Acknowledgement

Brand and product names are trademarks or registered trademarks of their respective owners.

Disclaimer

Avalue Technology Inc. reserves the right to make changes, without notice, to any product, including circuits and/or software described or contained in this manual in order to improve design and/or performance. Avalue Technology assumes no responsibility or liability for the use of the described product(s), conveys no license or title under any patent, copyright, or masks work rights to these products, and makes no representations or warranties that

these products are free from patent, copyright, or mask work right infringement, unless otherwise specified. Applications that are described in this manual are for illustration purposes only. Avalue Technology Inc. makes no representation or warranty that such application will be suitable for the specified use without further testing or modification.

Life Support Policy

Avalue Technology's PRODUCTS ARE NOT FOR USE AS CRITICAL COMPONENTS IN LIFE SUPPORT DEVICES OR SYSTEMS WITHOUT THE PRIOR WRITTEN APPROVAL OF Avalue Technology Inc.

As used herein:

1. Life support devices or systems are devices or systems which, (a) are intended for surgical implant into body, or (b) support or sustain life and whose failure to perform, when properly used in accordance with instructions for use provided in the labeling, can be reasonably expected to result in significant injury to the user.
2. A critical component is any component of a life support device or system whose failure to perform can be reasonably expected to cause the failure of the life support device or system, or to affect its safety or effectiveness.

A Message to the Customer

Avalue Customer Services

Each and every Avalue's product is built to the most exacting specifications to ensure reliable performance in the harsh and demanding conditions typical of industrial environments. Whether your new Avalue device is destined for the laboratory or the factory floor, you can be assured that your product will provide the reliability and ease of operation for which the name Avalue has come to be known.

Your satisfaction is our primary concern. Here is a guide to Avalue's customer services. To ensure you get the full benefit of our services, please follow the instructions below carefully.

Technical Support

We want you to get the maximum performance from your products. So if you run into technical difficulties, we are here to help. For the most frequently asked questions, you can easily find answers in your product documentation. These answers are normally a lot more detailed than the ones we can give over the phone. So please consult the user's manual first.

To receive the latest version of the user's manual; please visit our Web site at:

<http://www.avalue.com.tw/>

Product Warranty

Avalue warrants to you, the original purchaser, that each of its products will be free from defects in materials and workmanship for two years from the date of purchase.

This warranty does not apply to any products which have been repaired or altered by persons other than repair personnel authorized by Avalue, or which have been subject to misuse, abuse, accident or improper installation. Avalue assumes no liability under the terms of this warranty as a consequence of such events. Because of Avalue's high quality-control standards and rigorous testing, most of our customers never need to use our repair service. If any of Avalue's products is defective, it will be repaired or replaced at no charge during the warranty period. For out-of-warranty repairs, you will be billed according to the cost of replacement materials, service time, and freight. Please consult your dealer for more details. If you think you have a defective product, follow these steps:

1. Collect all the information about the problem encountered. (For example, CPU type and speed, Avalue's products model name, hardware & BIOS revision number, other hardware and software used, etc.) Note anything abnormal and list any on-screen messages you get when the problem occurs.
2. Call your dealer and describe the problem. Please have your manual, product, and any helpful information available.
3. If your product is diagnosed as defective, obtain an RMA (return material authorization) number from your dealer. This allows us to process your good return more quickly.
4. Carefully pack the defective product, a complete Repair and Replacement Order Card and a photocopy proof of purchase date (such as your sales receipt) in a shippable container. A product returned without proof of the purchase date is not eligible for warranty service.
5. Write the RMA number visibly on the outside of the package and ship it prepaid to your dealer.

Content

1. Getting Started	8
1.1 Safety Precautions.....	8
1.2 Packing List.....	8
1.3 Document Amendment History	9
1.4 Manual Objectives.....	10
1.5 System Specifications	11
1.6 Architecture Overview—Block Diagram	13
2. Hardware Configuration	14
2.1 Product Overview.....	15
2.2 Jumper and Connector List.....	17
2.3 Setting Jumpers & Connectors	19
2.3.1 AT/ ATX Input power select (JAT1).....	19
2.3.2 Serial port 1 pin9 signal select (JRI)	19
2.3.3 Clear CMOS (JCMOS).....	20
2.3.4 LCD backlight brightness adjustment (JVR)	20
2.3.5 LCD Inverter connector (JBKL)	21
2.3.6 CPU fan connector (CPU_FAN).....	21
2.3.7 System fan connector (SYS_FAN).....	22
2.3.8 Serial port 2 connector (JCOM2)	22
2.3.9 Serial port 2 in RS-422/485 mode (J422_485).....	23
2.3.10 General purpose I/O connector (JDIO).....	23
2.3.11 SATA Power header 1/2 (SATAPW1/2)	24
2.3.12 Power connector (PWR)	24
2.3.13 On-board header for USB2.0 (JUSB)	25
2.3.14 LPC connector (JLPC)	25
2.3.15 LVDS connector (JLVDS)	26
2.3.16 Miscellaneous setting connector (JFP).....	27
2.3.17 SPI header (JSPI)	27
2.3.18 Battery connector (JBAT).....	28
2.3.19 Audio connector (JAUDIO)	28
2.3.19.1 Signal Description – Audio connector (JAUDIO).....	28
3. BIOS Setup	29
3.1 Introduction	30
3.2 Starting Setup	30
3.3 Using Setup	31
3.4 Getting Help.....	32

ECM-SKLH User's Manual

3.5	In Case of Problems.....	32
3.6	BIOS setup.....	33
3.6.1	Main Menu.....	33
3.6.1.1	System Language.....	34
3.6.1.2	System Date	34
3.6.1.3	System Time.....	34
3.6.2	Advanced Menu	35
3.6.2.1	Trusted Computing	35
3.6.2.2	APCI Settings	36
3.6.2.3	IT8528 Super IO Configuration.....	37
3.6.2.3.1	Serial Port 1 Configuration	38
3.6.2.3.2	Serial Port 2 Configuration	38
3.6.2.4	AMT Configuration.....	39
3.6.2.5	PCH-FW Configuration	40
3.6.2.5.1	Firmware Update Configuration.....	41
3.6.2.6	H/W Monitor.....	41
3.6.2.6.1	Smart Fan Mode Configuration	42
3.6.2.7	S5 RTC Wake Settings.....	43
3.6.2.8	Serial Port Console Redirection	45
3.6.2.9	CPU Configuration.....	46
3.6.2.10	Intel TXT Configuration.....	47
3.6.2.11	SATA Configuration	48
3.6.2.12	Network Stack Configuration	49
3.6.2.13	CSM Configuration	50
3.6.2.14	USB Configuration	52
3.6.3	Chipset.....	53
3.6.3.1	System Agent (SA) Configuration.....	53
3.6.3.1.1	Graphics Configuration	54
3.6.3.1.2	DMI/OPI Configuration	55
3.6.3.1.3	Memory Configuration	56
3.6.3.1.4	GT- Power Management Control.....	57
3.6.3.2	PCH-IO Configuration.....	57
3.6.3.2.1	PCI Express Configuration	58
3.6.3.2.2	USB Configuration	60
3.6.3.2.3	HD Audio Configuration	60
3.6.4	Security.....	61
3.6.4.1	Secure Boot menu	62
3.6.5	Boot	63
3.6.6	Save and exit.....	64
3.6.6.1	Save Changes and Reset.....	64

3.6.6.2	Discard Changes and Reset.....	64
3.6.6.3	Restore Defaults	64
3.6.6.4	Launch EFI Shell from filesystem device	64
4.	Drivers Installation.....	65
4.1	Install Chipset Driver	66
4.2	Install ME Driver	67
4.3	Install VGA Driver.....	68
4.4	Install Audio Driver (For Realtek ALC233)	69
4.5	Install Ethernet Driver.....	70
4.6	Install RST Driver	72
5.	Mechanical Drawing	74

1. Getting Started

1.1 Safety Precautions

Warning!



Always completely disconnect the power cord from your chassis whenever you work with the hardware. Do not make connections while the power is on. Sensitive electronic components can be damaged by sudden power surges. Only experienced electronics personnel should open the PC chassis.

Caution!



Always ground yourself to remove any static charge before touching the CPU card. Modern electronic devices are very sensitive to static electric charges. As a safety precaution, use a grounding wrist strap at all times. Place all electronic components in a static-dissipative surface or static-shielded bag when they are not in the chassis.

1.2 Packing List

Before you begin installing your single board, please make sure that the following materials have been shipped:

- 1 x 3.5" ECM-SKLH Micro Module
- 1 x DVD-ROM contains the followings:
 - User's Manual (this manual in PDF file)
 - Ethernet driver and utilities
 - VGA drivers and utilities
 - Audio drivers and utilities
- 1 x Cable set contains the followings:
 - 1 x Audio cable (12pin, 2.0 pitch)
 - 1 x USB 2.0 cable (10P/2.0mm-10P/2.0mm)
 - 1 x Serial ATA cable (7-pin, standard)
 - 1 x Wire SATA power cable (15-pin, 4P/2.5mm)
 - 1 x Flat Cable 9P(M)-PHD (10P/2.0mm)
- 3M foam (VHB-4622 10mm*20mm*1.1mm)



If any of the above items is damaged or missing, contact your retailer.

1.3 Document Amendment History

Revision	Date	By	Comment
1 st	January 2016	Avalue	Initial Release
2 nd	September 2016	Avalue	Update Setting Jumpers & Connectors

1.4 Manual Objectives

This manual describes in details Avalue Technology ECM-SKLH Single Board.

We have tried to include as much information as possible but we have not duplicated information that is provided in the standard IBM Technical References, unless it proved to be necessary to aid in the understanding of this board.

We strongly recommend that you study this manual carefully before attempting to set up ECM-SKLH or change the standard configurations. Whilst all the necessary information is available in this manual we would recommend that unless you are confident, you contact your supplier for guidance.

Please be aware that it is possible to create configurations within the NVRAM that make booting impossible. If this should happen, clear the NVRAM settings, (see the description of the Jumper Settings for details).

If you have any suggestions or find any errors regarding this manual and want to inform us of these, please contact our Customer Service department with the relevant details.

1.5 System Specifications

System	
CPU	Onboard 6th generation Intel® Skylake H Processor 45W/35W/25W (CPU GT4 not support)
BIOS	AMI uEFI BIOS, 128 Mbit SPI Flash ROM iAMT supported
System Chipset	Intel® Skylake PCH-H QM170 Corp
I/O Chip	EC(IT8528E)
System Memory	1 x 260-Pin DDR4 2133MTs SO-DIMM (support non-ECC only)
SSD	1 x M.2(2242) SSD (B key support SATA or PCIe x1 & USB3 only & USB2) mSATA from MiniPCIe
Watchdog Timer	H/W Reset, 1sec. - 65535sec.
H/W Status Monitor	Monitoring System Temperature, Voltage and FAN Status with Auto Throttling Control
Expansion	1 x Full-Size Mini PCI Express Mini Card with mSATA supported
I/O	
MIO	2 x SATA III, 1 x RS232 (COM1) 1 x RS232/422/485 COM2, LPC, SPI
USB	4 x USB3.0 (dual deck USB connector for 2 USB3.0 port), 2 x USB 2.0 (Wafer)
GPIO	8-bit GPIO
Display	
Chipset	Intel® Skylake Processor integrated Graphics
Resolution	LVDS: 1920 x 1080@60Hz 2 x HDMI: 3840 x 2160@24Hz
Multiple Display	Triple display
HDMI	HDMI 1.4b
LCD Interface	Dual channel 18/24-bit LVDS (via 7511B)
Audio	
AC97 Codec	Realtek ALC233 HD codec Supports 2.1-CH Audio
Audio Amp	Internal AMP, Class-D amplifier has 2 Watt (rms)/4Ω per channel output Line in, Line-Out, Mic in
Ethernet	
LAN Chip	1 x Intel I210AT GbE controller 1 x Intel I219LM Gigabit Ethernet PHY

ECM-SKLH User's Manual

Ethernet Interface	10/100/1000 Base-Tx compatible
Internal I/O Connectors	
Fan	2 x Fan 4P-Wafer
Buzzer	On board Buzzer
CMOS Battery	Wire CR2032
Power On	2 x 4-pin header
Audio	2 x 8-pin header
COM	1 x RS232/422/485 (COM2)
USB	2 x 5-pin header
Rear I/O Connectors	
USB	4 x USB3.0
LAN	2 x Ethernet
HDMI	2 x HDMI
LED	Front Panel LED Connector (for system use)
COM	1 x RS232
Mechanical & Environmental	
Power Requirement	+12V
ACPI	Single power ATX Support S0, S3, S4, S5 ACPI 5.0 Compliant
Power Type	AT / ATX
Operating Temp.	0°C ~ 60°C
Storage Temp.	-40°C ~ 75°C
Operating Humidity	0% ~ 90% relative humidity, non-condensing
Size (L x W)	5.7" x 4" (146mm x 101mm)
Weight	0.44lbs (0.2kg)



Note: Specifications are subject to change without notice.

1.6 Architecture Overview—Block Diagram

The following block diagram shows the architecture and main components of ECM-SKLH.

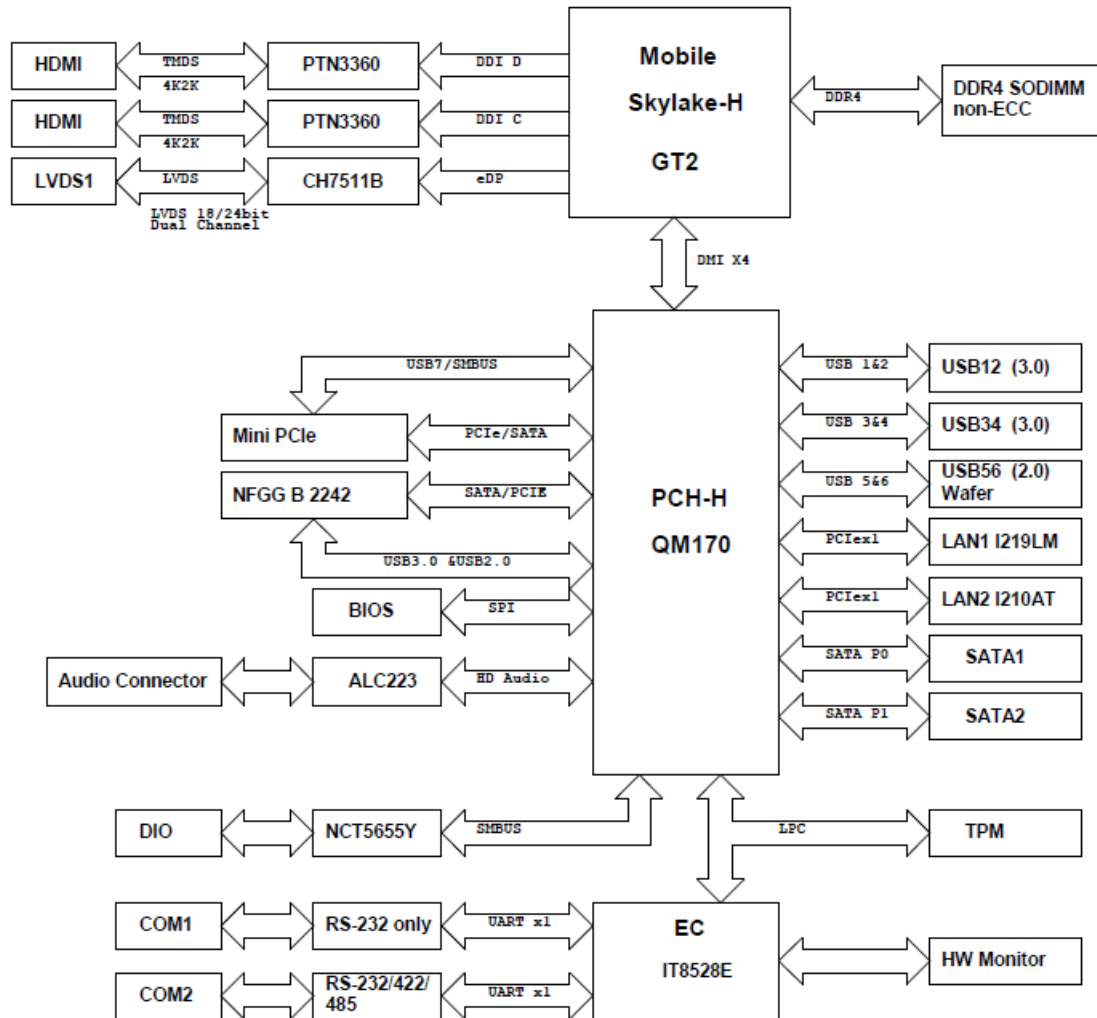

2. Hardware Configuration

2.1 Product Overview

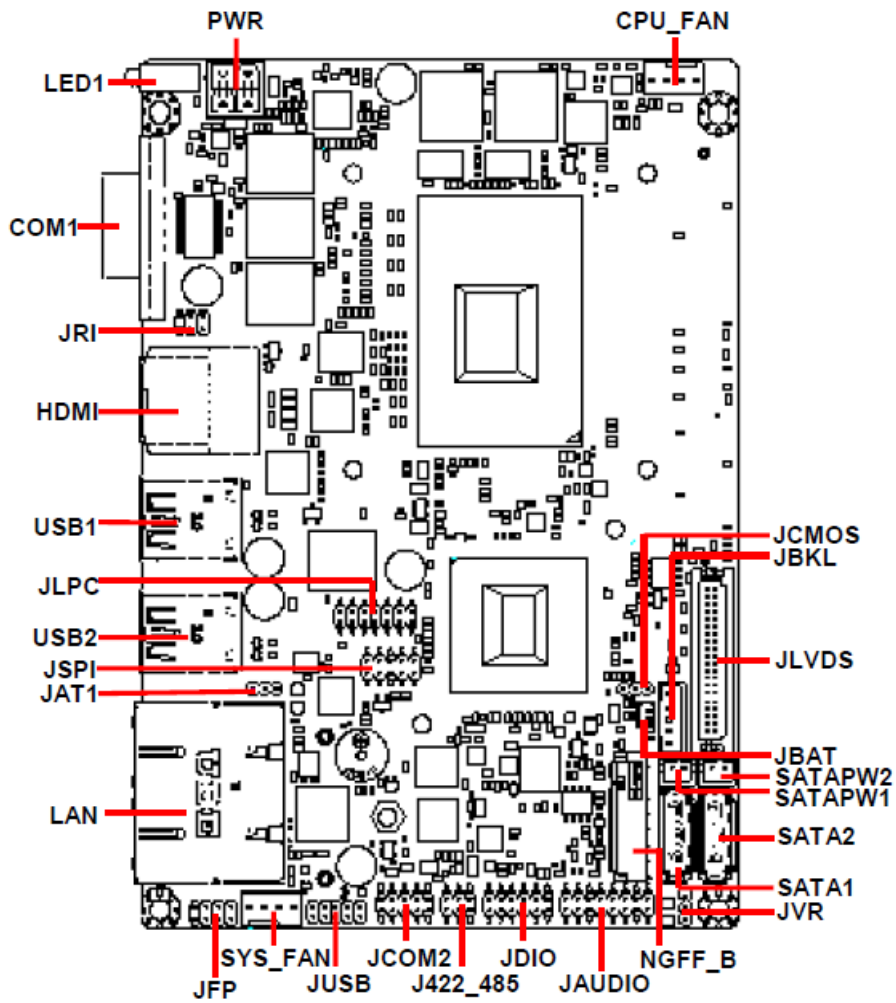

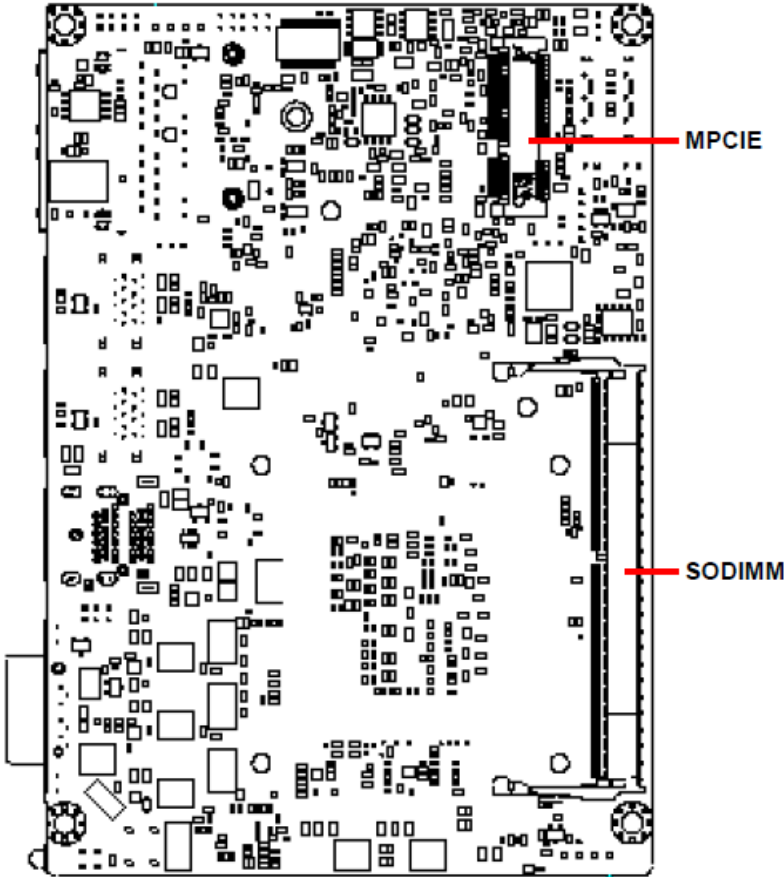

2.2 Jumper and Connector List

You can configure your board to match the needs of your application by setting jumpers. A jumper is the simplest kind of electric switch.

It consists of two metal pins and a small metal clip (often protected by a plastic cover) that slides over the pins to connect them. To “close” a jumper you connect the pins with the clip. To “open” a jumper you remove the clip. Sometimes a jumper will have three pins, labeled 1, 2, and 3. In this case, you would connect either two pins.

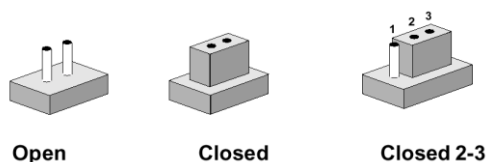

The jumper settings are schematically depicted in this manual as follows:



A pair of needle-nose pliers may be helpful when working with jumpers.

Connectors on the board are linked to external devices such as hard disk drives, a keyboard, or floppy drives. In addition, the board has a number of jumpers that allow you to configure your system to suit your application.

If you have any doubts about the best hardware configuration for your application, contact your local distributor or sales representative before you make any changes.

The following tables list the function of each of the board's jumpers and connectors.

Jumpers

Label	Function	Note
JCMOS	Clear CMOS	3 x 1 header, pitch 2.00 mm
JRI	Serial port 1 pin9 signal select	3 x 2 header, pitch 2.00 mm
JAT1	AT/ ATX Input power select	3 x 1 header, pitch 2.00 mm
JVR	LCD backlight brightness adjustment	3 x 1 header, pitch 2.00 mm

Connectors

Label	Function	Note
JBAT	Battery connector	2 x 1 wafer, pitch 1.25 mm
CPU_FAN	CPU fan connector	4 x 1 wafer, pitch 2.54 mm
SYS_FAN	System fan connector	4 x 1 wafer, pitch 2.54mm
JAUDIO	Audio connector	8 x 2 header, pitch 2.00 mm

ECM-SKLH User's Manual

JBKL	LCD inverter connector	5 x 1 wafer, pitch 2.00 mm
J422_485	Serial port 2 in RS-422/485 mode	3 x 2 header, pitch 2.00 mm
COM1	Serial port 1 connector	D-sub 9-pin, male
JCOM2	Serial port 2 connector	5 x 2 header, pitch 2.00 mm
JDIO	General purpose I/O connector	6 x 2 header, pitch 2.00 mm
JFP	Miscellaneous setting connector	4 x 2 header, pitch 2.00 mm
JLPC	Low pin count interface	7 x 2 header, pitch 2.00 mm
JLVDS	LVDS connector	20 x 2 header, pitch 1.25 mm
JSPI	SPI connector	5 x 2 header, pitch 2.00mm
USB1/2	On-board connector for USB3.0 x 4	
JUSB	On-board header for USB2.0	5 x 2 header, pitch 2.00 mm
HDMI1	DUAL HDMI connector	
LAN	RJ-45 Ethernet connector x 2	
LED1	HDD/Power LED indicator	
PWR	Power connector	2 x 2 wafer, pitch 4.20 mm
SATAPW1/2	SATA power header 1/2	2 x 1 wafer, pitch 2.00 mm
SATA1/2	Serial ATA connector 1/2	
NGFF_B	M.2 KEY-B 2242 connector	
MPCIE	Full size Mini-PCI-e connector	
SODIMM	DDR4 SODIMM socket	

2.3 Setting Jumpers & Connectors

2.3.1 AT/ ATX Input power select (JAT1)

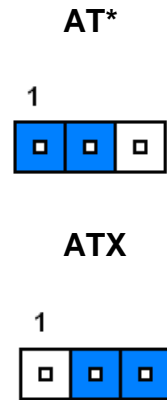
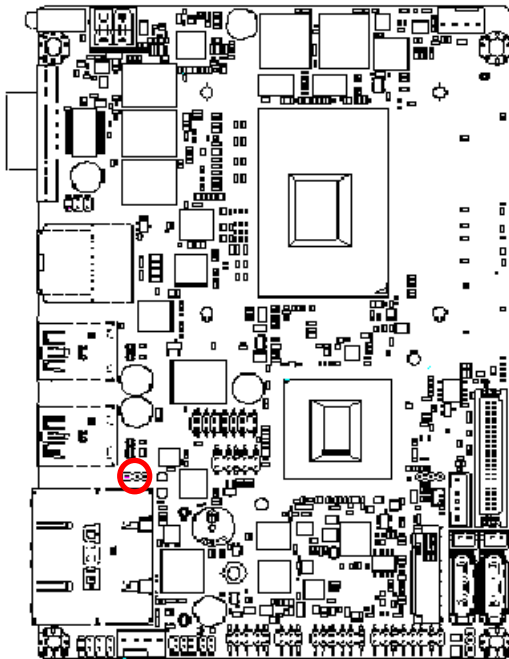

2.3.2 Serial port 1 pin9 signal select (JRI)

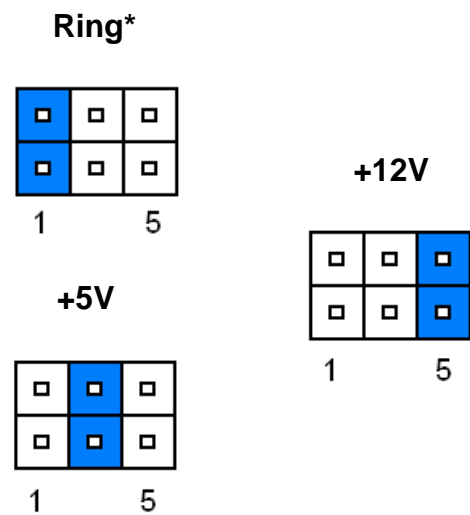
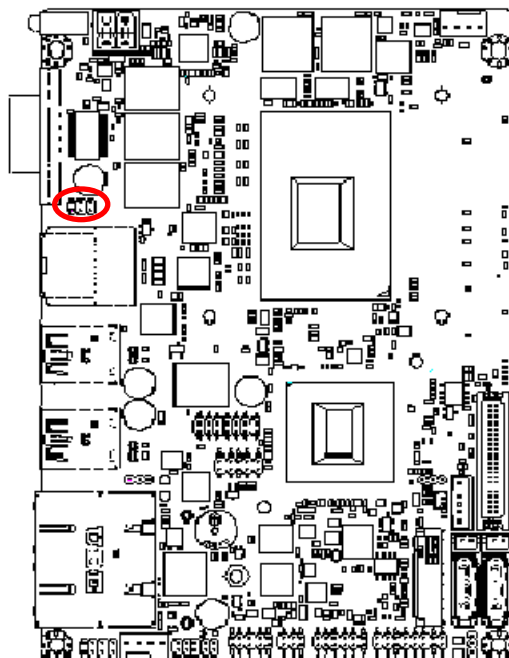

* Default

2.3.3 Clear CMOS (JCMOS)

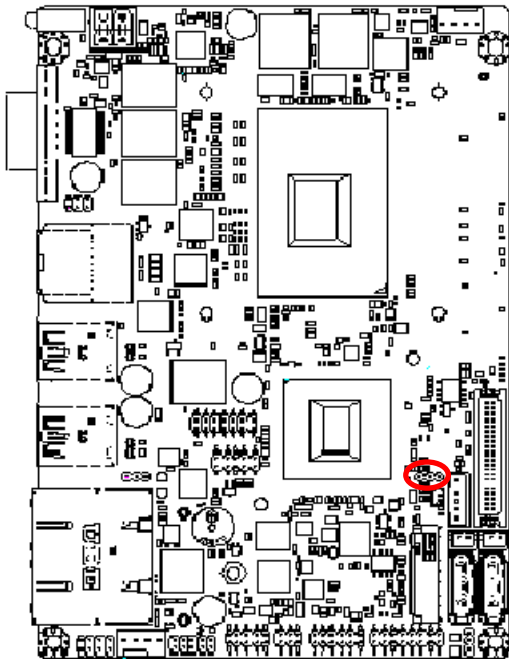

Protect*



Clear CMOS

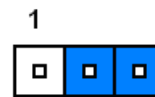

* Default

2.3.4 LCD backlight brightness adjustment (JVR)

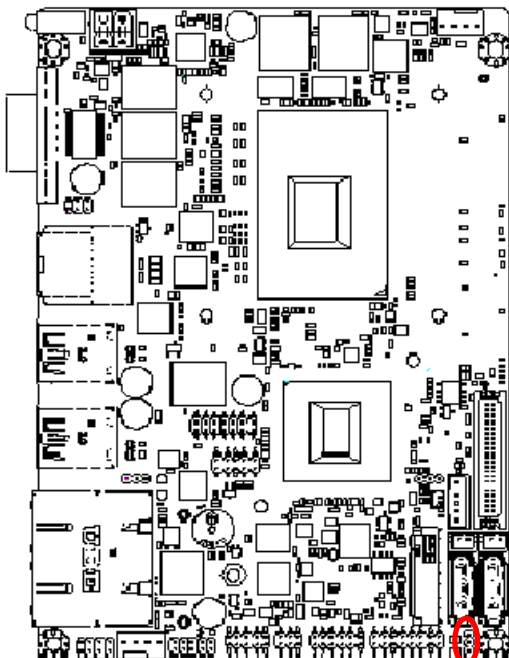

DC Mode*



PWM Mode



* Default

2.3.5 LCD Inverter connector (JBKL)

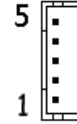
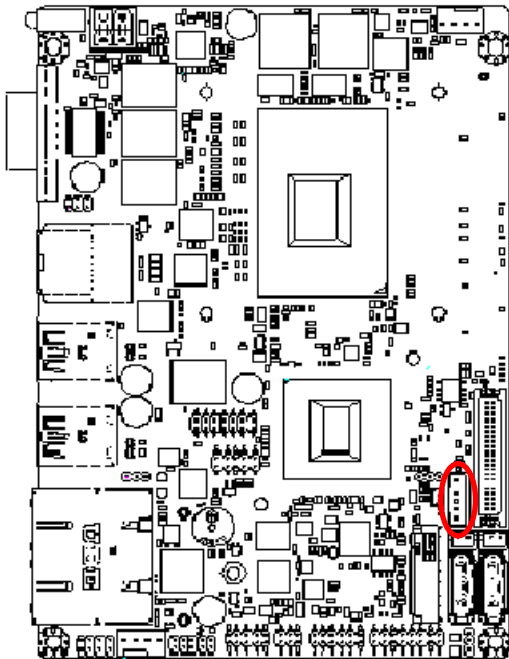

Signal	PIN
+5V	5
VBRIGHT	4
BKLEN	3
GND	2
+12V	1

2.3.6 CPU fan connector (CPU_FAN)

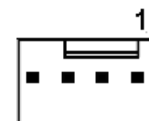
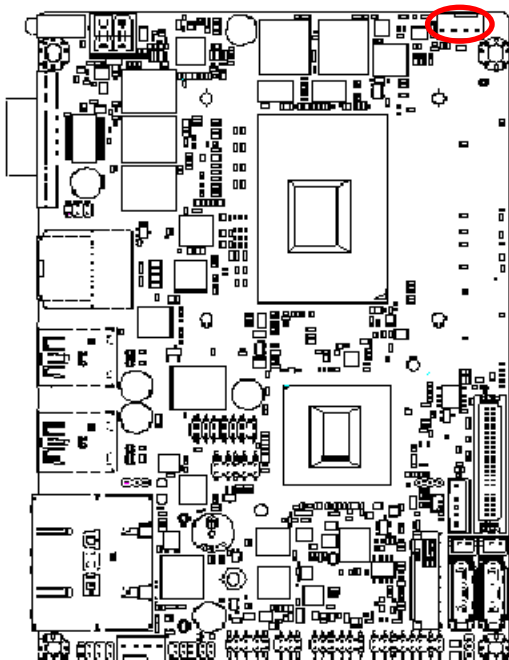

Signal	PIN
GND	1
+12V	2
EC_TACH0	3
FAN_PWM0	4

2.3.7 System fan connector (SYS_FAN)

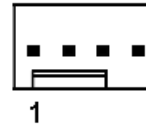
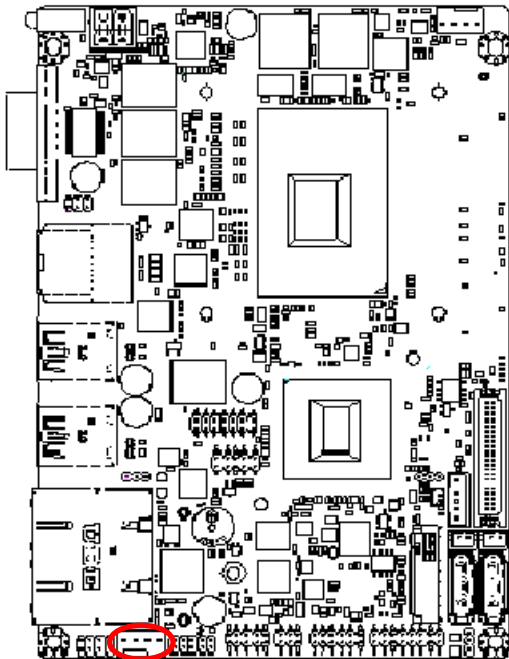

Signal	PIN
GND	1
+12V	2
EC_TACH1	3
FAN_PWM1	4

2.3.8 Serial port 2 connector (JCOM2)

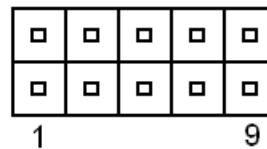
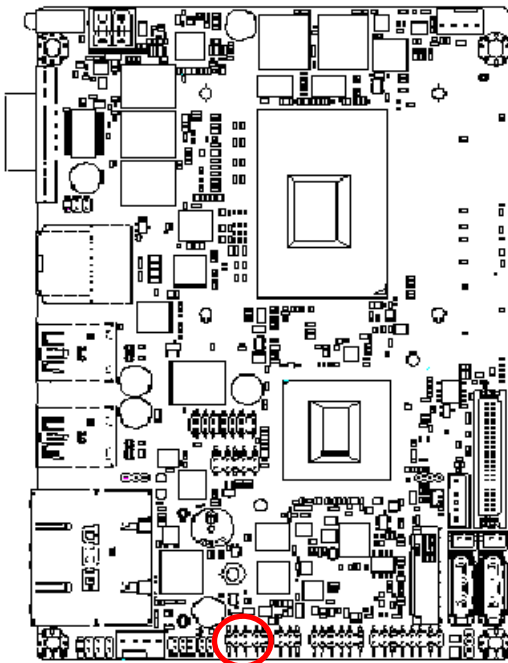

Signal	PIN	PIN	Signal
COM_DCD#	1	2	COM_RXD#
COM_TXD	3	4	COM_DTR#
GND	5	6	COM_DSR#
COM_RTS#	7	8	COM_CTS#
COM_RI#	9	10	NC

2.3.9 Serial port 2 in RS-422/485 mode (J422_485)

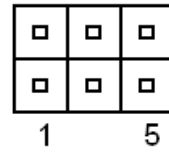
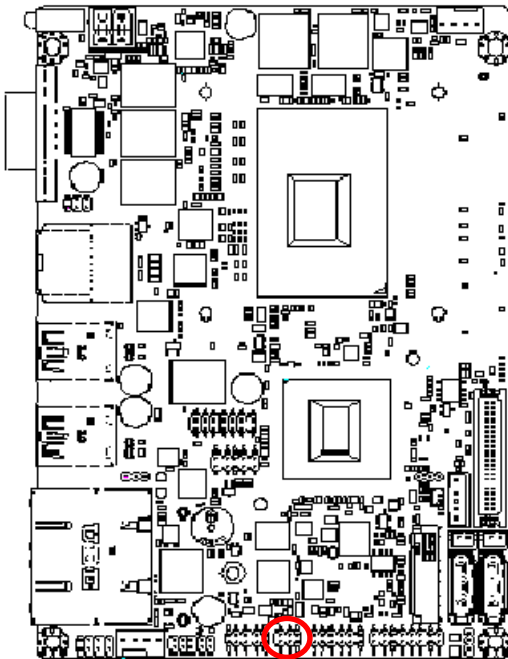

Signal	PIN	PIN	Signal
485-422_TXDN	1	2	422_RXDN
485-422_TXDP	3	4	422_RXDP
+5V	5	6	GND

2.3.10 General purpose I/O connector (JDIO)

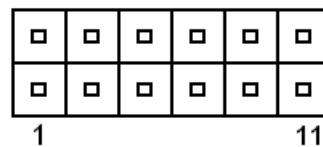
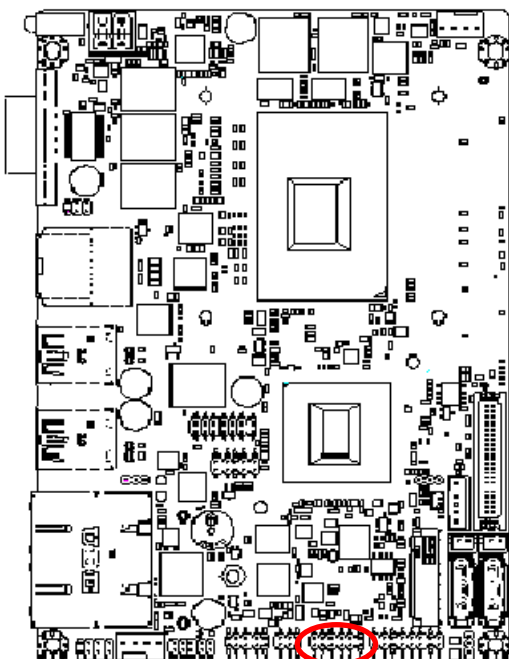

Signal	PIN	PIN	Signal
DIO_GP10	1	2	DIO_GP20
DIO_GP11	3	4	DIO_GP21
DIO_GP12	5	6	DIO_GP22
DIO_GP13	7	8	DIO_GP23
SMB_CLK_VCC	9	10	SMB_DATA_VCC
GND	11	12	+5V

2.3.11 SATA Power header 1/2 (SATAPW1/2)

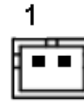
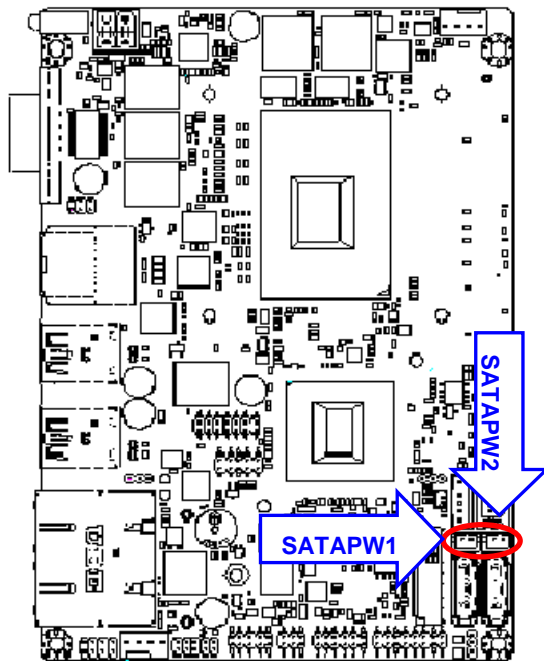

Signal	PIN
GND	1
+5V	2

2.3.12 Power connector (PWR)

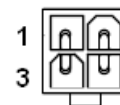
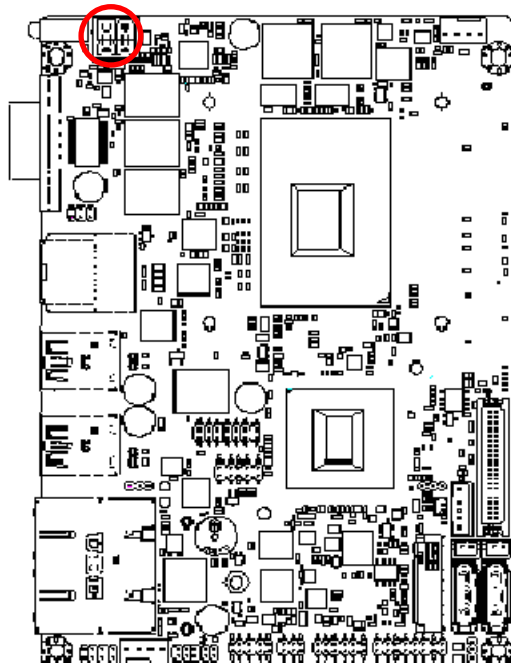

Signal	PIN	PIN	Signal
GND	1	2	GND
+12V	3	4	+12V

2.3.13 On-board header for USB2.0 (JUSB)

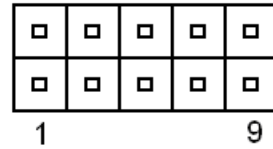
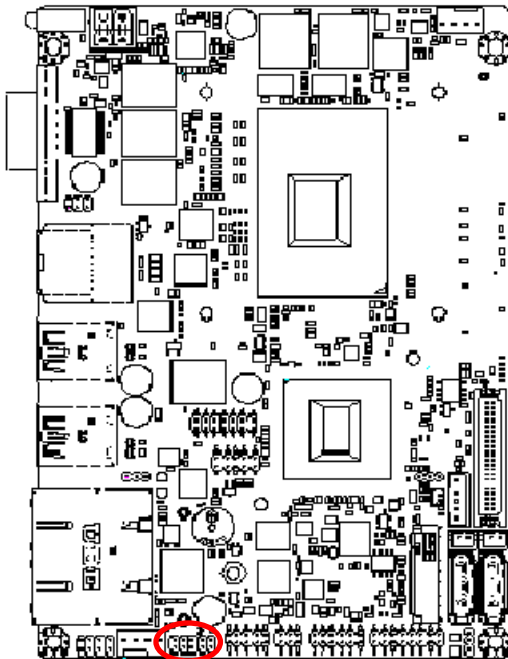

Signal	PIN	PIN	Signal
+5VSB	1	2	GND
USB_DN4	3	4	GND
USB_DP4	5	6	USB_DP5
GND	7	8	USB_DN5
GND	9	10	+5VSB

2.3.14 LPC connector (JLPC)

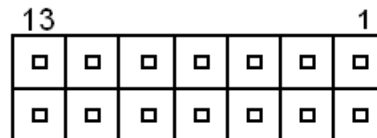
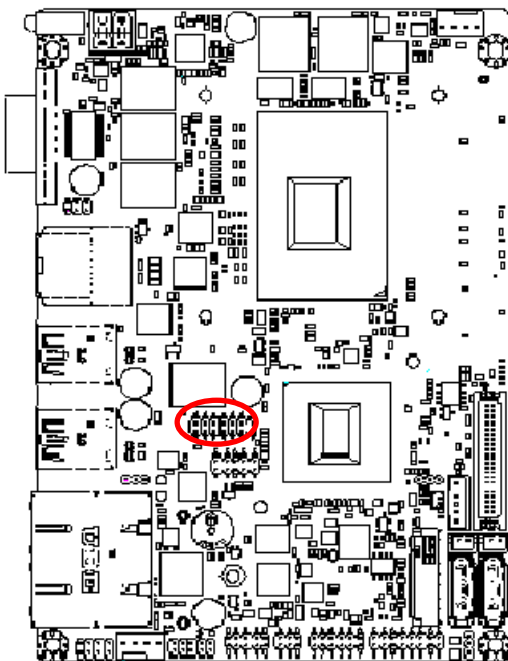

Signal	PIN	PIN	Signal
LPC_AD0	1	2	+3.3V
LPC_AD1	3	4	PLTRST#
LPC_AD	5	6	LPC_LFRAME#
LPC_AD03	7	8	CLK_PCI_JLPC
SERIRQ	9	10	GND
+5V	11	12	GND
+5VSB	13	14	GND

2.3.15 LVDS connector (JLVDS)

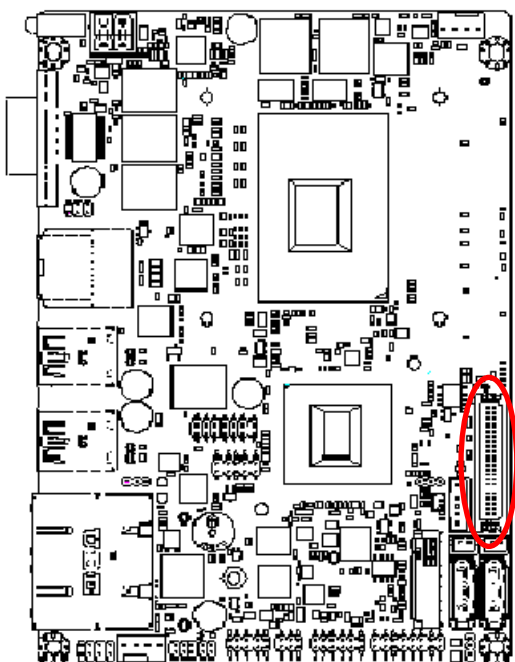

Signal	PIN	PIN	Signal
+12V	39	40	+12V
GND	37	38	GND
LVDS_CLK2_N	35	36	LVDS_CLK1_N
LVDS_CLK2_P	33	34	LVDS_CLK1_P
GND	31	32	GND
LVDS_DATA7_N	29	30	LVDS_DATA6_N
LVDS_DATA7_P	27	28	LVDS_DATA6_P
GND	25	26	GND
LVDS_DATA5_N	23	24	LVDS_DATA4_N
LVDS_DATA5_P	21	22	LVDS_DATA4_P
GND	19	20	GND
LVDS_DATA3_N	17	18	LVDS_DATA2_N
LVDS_DATA3_P	15	16	LVDS_DATA2_P
GND	13	14	GND
LVDS_DATA1_N	11	12	LVDS_DATA0_N
LVDS_DATA1_P	9	10	LVDS_DATA0_P
GND	7	8	GND
LVDS_DDC_CLK	5	6	LVDS_DDC_DATA
+3.3V	3	4	+5V
+3.3V	1	2	+5V

2.3.16 Miscellaneous setting connector (JFP)

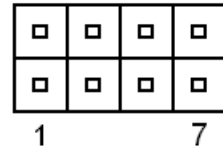
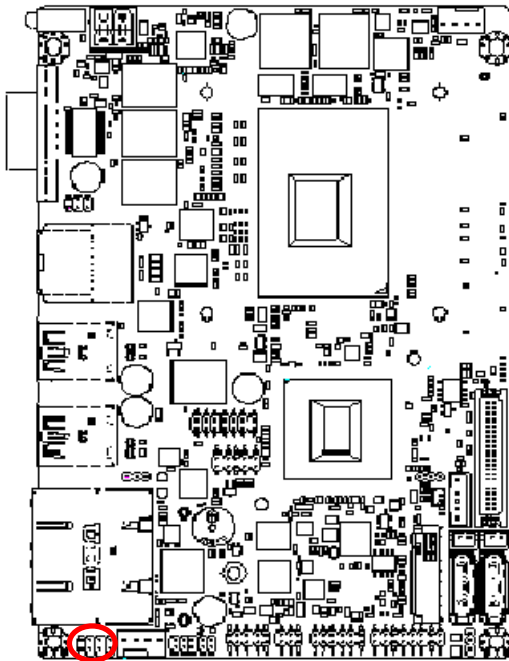

Signal	PIN	PIN	Signal
PWR_BTN_IN_EC#	1	2	GND
RESET_BT	3	4	GND
+5VSB	5	6	PWR_LED-
HDD_LED#	7	8	+5V

2.3.17 SPI header (JSPI)

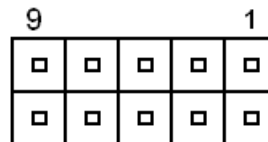
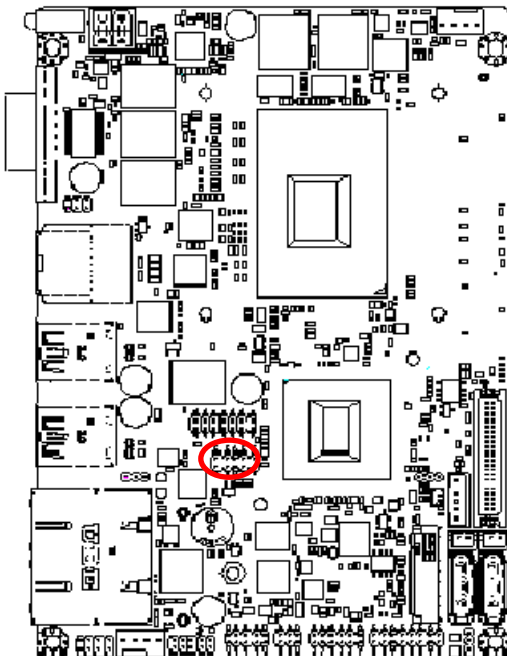

Signal	PIN	PIN	Signal
+3.3VSB	1	2	GND
SPI_CS0#	3	4	SPI_CLK
SPI_SO	5	6	SPI_SI
HOLD#	7	8	NC
EC_SMCLK_DEBUG	9	10	EC_SMDAT_DEBUG

ECM-SKLH User's Manual

2.3.18 Battery connector (JBAT)

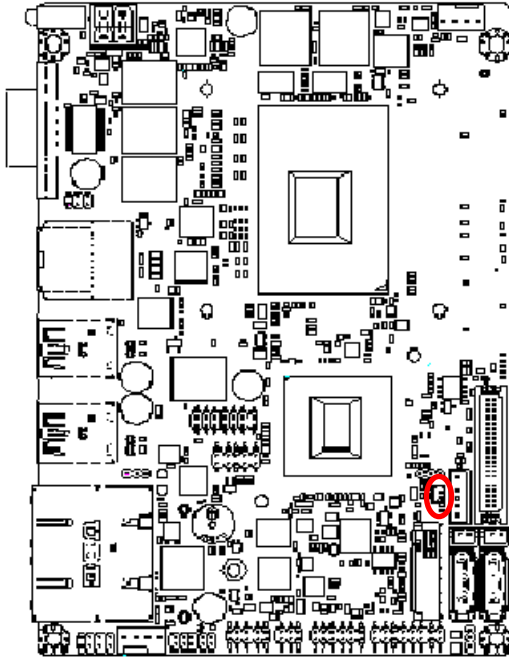

Signal	PIN
GND	2
+3.3V	1

2.3.19 Audio connector (JAUDIO)

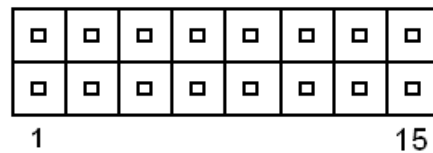
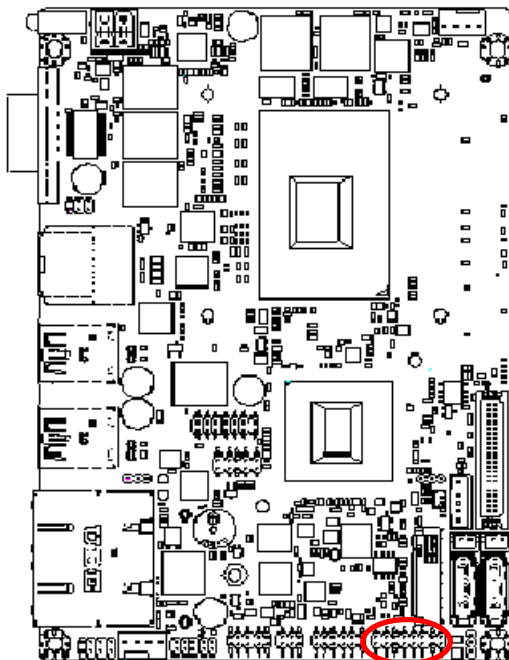

Signal	PIN	PIN	Signal
FRONT-R-OUT	1	2	FRONT-L-OUT
HD_AGND	3	4	HD_AGND
LINE1-R-IN	5	6	LIN1-L-IN
MIC1-R-IN	7	8	MIC1-L-IN
FRONT-JD	9	10	LINE1-JD
MIC1-JD	11	12	HD_AGND
SPK_L+	13	14	SPK_R+
SPK_L-	15	16	SPK_R-

2.3.19.1 Signal Description – Audio connector (JAUDIO)

Signal	Signal Description
LINE1-JD	AUDIO IN (LINE_RIN/LIN)sense pin
FRONT-JD	AUDIO Out(ROUT/LOUT) sense pin
MIC1-JD	MIC IN (MIC_RIN/LIN) sense pin

3. BIOS Setup

3.1 Introduction

The BIOS setup program allows users to modify the basic system configuration. In this following chapter will describe how to access the BIOS setup program and the configuration options that may be changed.

3.2 Starting Setup

AMI BIOS™ is immediately activated when you first power on the computer. The BIOS reads the system information contained in the NVRAM and begins the process of checking out the system and configuring it. When it finishes, the BIOS will seek an operating system on one of the disks and then launch and turn control over to the operating system.

While the BIOS is in control, the Setup program can be activated in one of two ways:

By pressing <F2> or immediately after switching the system on, or

By pressing the <F2> or key when the following message appears briefly at the left-top of the screen during the POST (Power On Self Test).

Press <F2> or to enter SETUP

If the message disappears before you respond and you still wish to enter Setup, restart the system to try again by turning it OFF then ON or pressing the "RESET" button on the system case. You may also restart by simultaneously pressing <Ctrl>, <Alt>, and <Delete> keys.

3.3 Using Setup

In general, you use the arrow keys to highlight items, press <Enter> to select, use the PageUp and PageDown keys to change entries, press <F1> for help and press <Esc> to quit. The following table provides more detail about how to navigate in the Setup program using the keyboard.

Button	Description
↑	Move to previous item
↓	Move to next item
←	Move to the item in the left hand
→	Move to the item in the right hand
Esc key	Main Menu -- Quit and not save changes into NVRAM Status Page Setup Menu and Option Page Setup Menu -- Exit current page and return to Main Menu
+ key	Increase the numeric value or make changes
- key	Decrease the numeric value or make changes
F1 key	General help, only for Status Page Setup Menu and Option Page Setup Menu
F2 key	Previous Values
F3 key	Optimized defaults
F4 key	Save & Exit Setup

- **Navigating Through The Menu Bar**

Use the left and right arrow keys to choose the menu you want to be in.



Note: Some of the navigation keys differ from one screen to another.

- **To Display a Sub Menu**

Use the arrow keys to move the cursor to the sub menu you want. Then press <Enter>. A “➤” pointer marks all sub menus.

3.4 Getting Help

Press F1 to pop up a small help window that describes the appropriate keys to use and the possible selections for the highlighted item. To exit the Help Window press <Esc> or the F1 key again.

3.5 In Case of Problems

If, after making and saving system changes with Setup, you discover that your computer no longer is able to boot, the Insyde BIOS supports an override to the NVRAM settings which resets your system to its defaults.

The best advice is to only alter settings which you thoroughly understand. To this end, we strongly recommend that you avoid making any changes to the chipset defaults. These defaults have been carefully chosen by both your systems manufacturer to provide the absolute maximum performance and reliability. Even a seemingly small change to the chipset setup has the potential for causing you to use the override.

3.6 BIOS setup

Once you enter the Aptio Setup Utility, the Main Menu will appear on the screen. The Main Menu allows you to select from several setup functions and exit choices. Use the arrow keys to select among the items and press <Enter> to accept and enter the sub-menu.

3.6.1 Main Menu

This section allows you to record some basic hardware configurations in your computer and set the system clock.



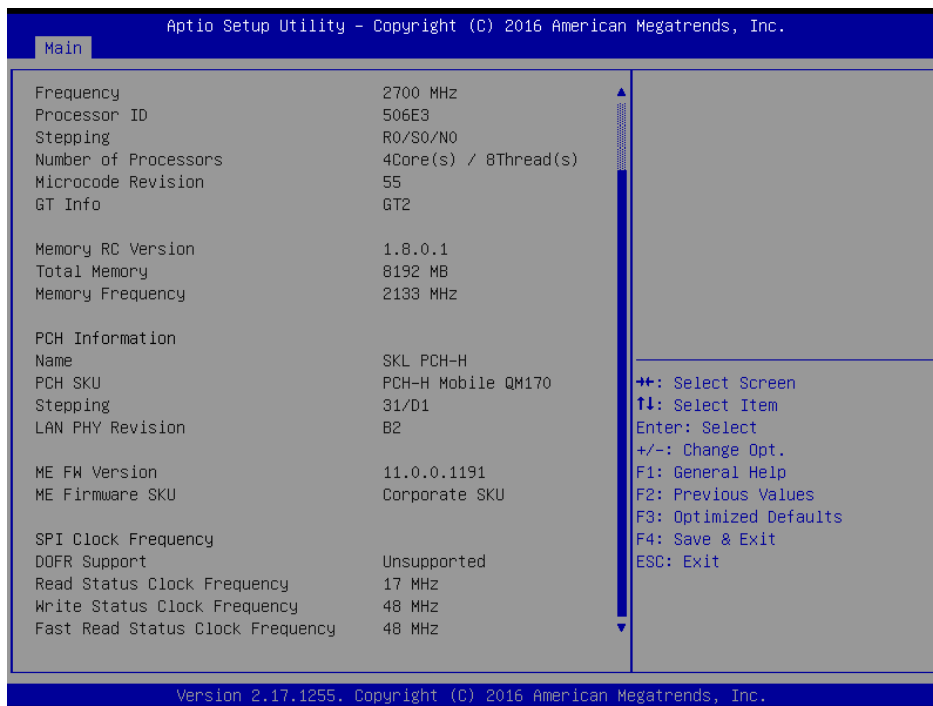

3.6.1.1 System Language

This option allows choosing the system default language.

3.6.1.2 System Date

Use the system date option to set the system date. Manually enter the day, month and year.

3.6.1.3 System Time

Use the system time option to set the system time. Manually enter the hours, minutes and seconds.



Note: The BIOS setup screens shown in this chapter are for reference purposes only, and may not exactly match what you see on your screen.

Visit the Avalue website (www.avalue.com.tw) to download the latest product and BIOS information.

3.6.2 Advanced Menu

This section allows you to configure your CPU and other system devices for basic operation through the following sub-menus.

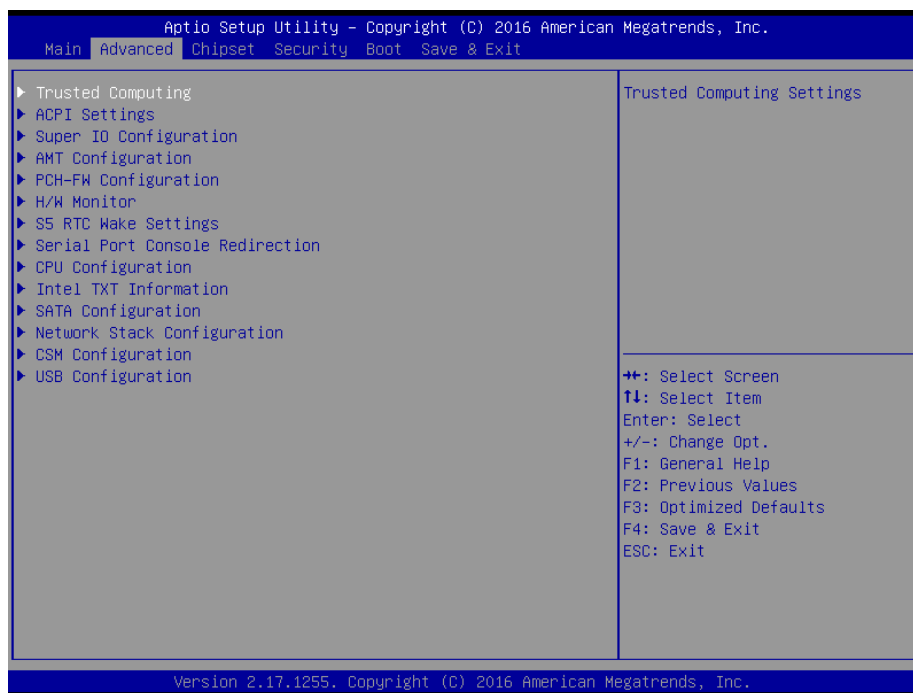

3.6.2.1 Trusted Computing

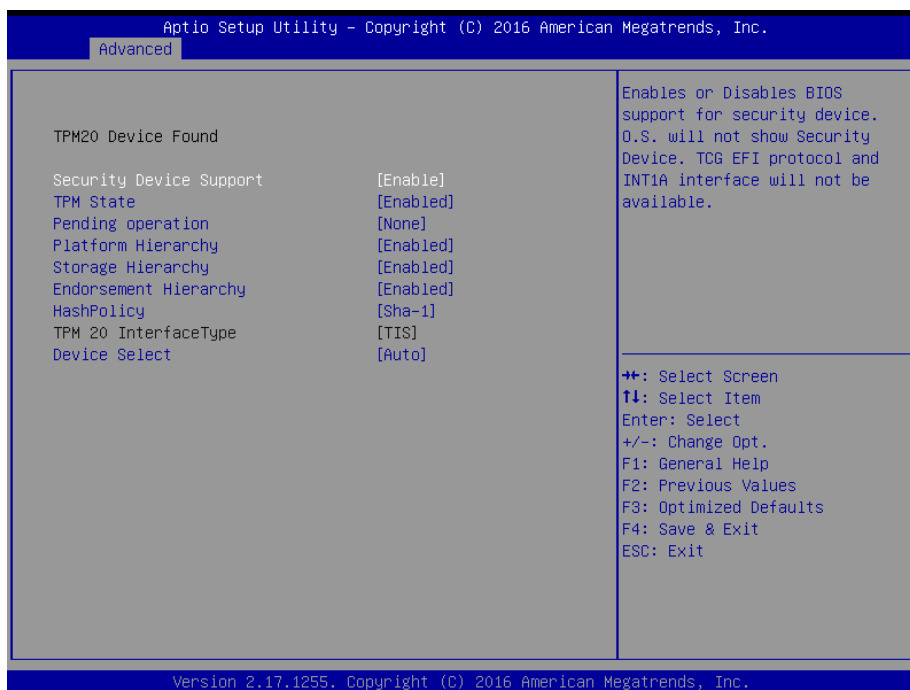

Item	Options	Description
Security Device Support	Disable, Enable[Default]	Enables or Disables BIOS support for security device. O.S. will not show Security Device. TCG EFI protocol and INT1A interface will not be

ECM-SKLH User's Manual

		available.
TPM State	Disabled Enabled[Default],	Enable/Disable Security Device. NOTE: Your Computer will reboot during restart in order to change State of the Device.
Pending operation	None[Default], TPM Clear	Schedule an Operation for the Security Device. NOTE: Your Computer will reboot during restart in order to change State of Security Device.
Platform Hierarchy	Disabled Enabled[Default],	Enable or Disable Platform Hierarchy.
Storage Hierarchy	Disabled Enabled[Default],	Enable or Disable Storage Hierarchy.
Endorsement Hierarchy	Disabled Enabled[Default],	Enable or Disable Endorsement Hierarchy.
Device Select	Auto[Default],	TPM 1.2 will restrict support to TPM 1.2 devices, TPM 2.0 will restrict support to TPM 2.0 devices, Auto will support both with the default set to TPM 2.0 devices if not found, TPM 1.2 devices will be enumerated.

3.6.2.2 APCI Settings

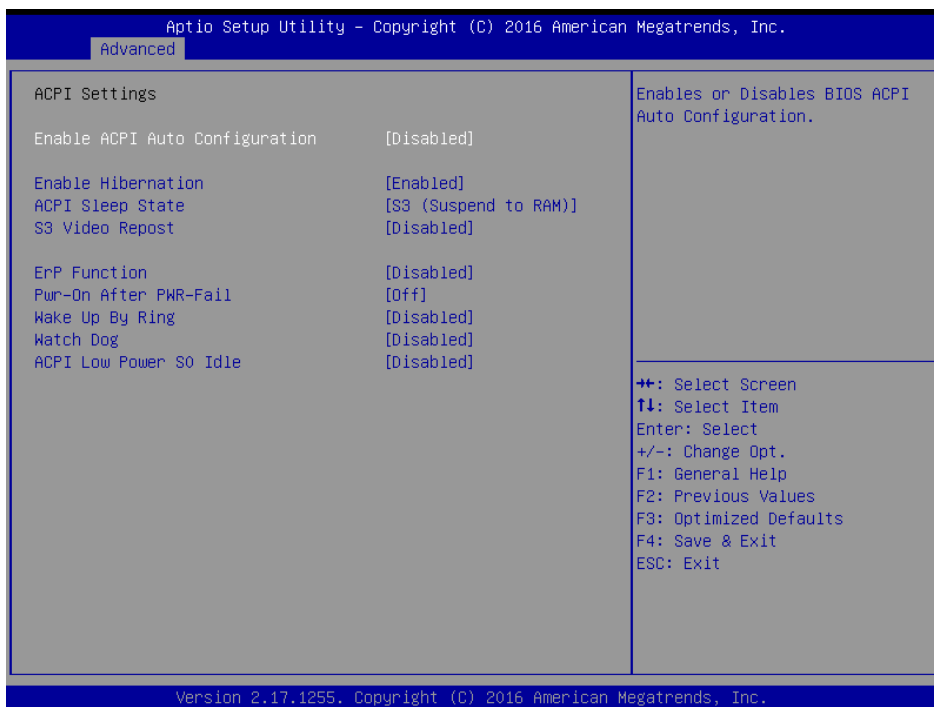

Item	Options	Description
Enable ACPI Auto Configuration	Disabled[Default], Enabled	Enables or Disables BIOS ACPI Auto Configuration.
Enable Hibernation	Disabled Enabled[Default],	Enables or Disables System ability to Hibernate (OS/S4 Sleep State). This option may be not effective with some OS.

ACPI Sleep State	Suspend Disabled, S3 (Suspend to RAM) [Default]	Select the highest ACPI sleep state the system will enter when the SUSPEND button is pressed.
S3 Video Repost	Disabled [Default] , Enabled	Enable or Disable S3 Video Repost.
ErP Function	Disabled [Default] , Enabled	ErP Function (Deep S5).
Pwr-On After PWR-Fail	Off [Default] On Last state	Select the power station after power failure.
Wake Up By Ring	Disabled [Default] , Enabled	System wake up by ring (from S3~S5).
Watch Dog	Disabled [Default] , 30 sec 40 sec 50 sec 1 min 2 min 10 min 30 min	Select Watch Dog Timer (WDT) Mode.
ACPI Low Power S0 Idle	Disabled [Default] , Enabled	Enable or Disable ACPI Low Power S0 Idle Support.

3.6.2.3 IT8528 Super IO Configuration

You can use this item to set up or change the IT8528 Super IO configuration for serial ports. Please refer to 3.6.2.3.1~ 3.6.2.3.2 for more information.

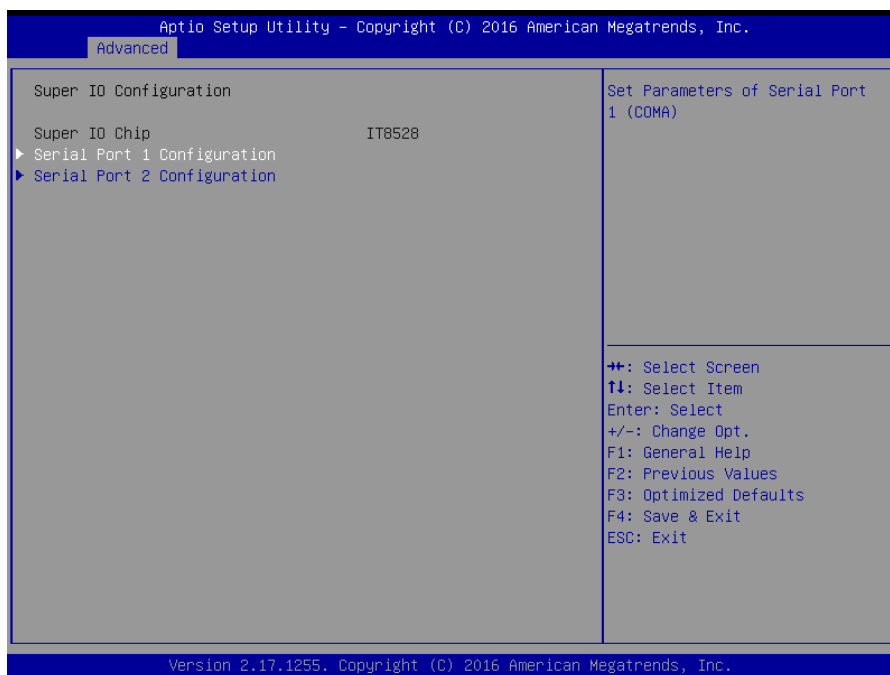

ECM-SKLH User's Manual

Item	Description
Serial Port 1 Configuration	Set Parameters of Serial Port 1 (COMA).
Serial Port 2 Configuration	Set Parameters of Serial Port 2 (COMB).

3.6.2.3.1 Serial Port 1 Configuration

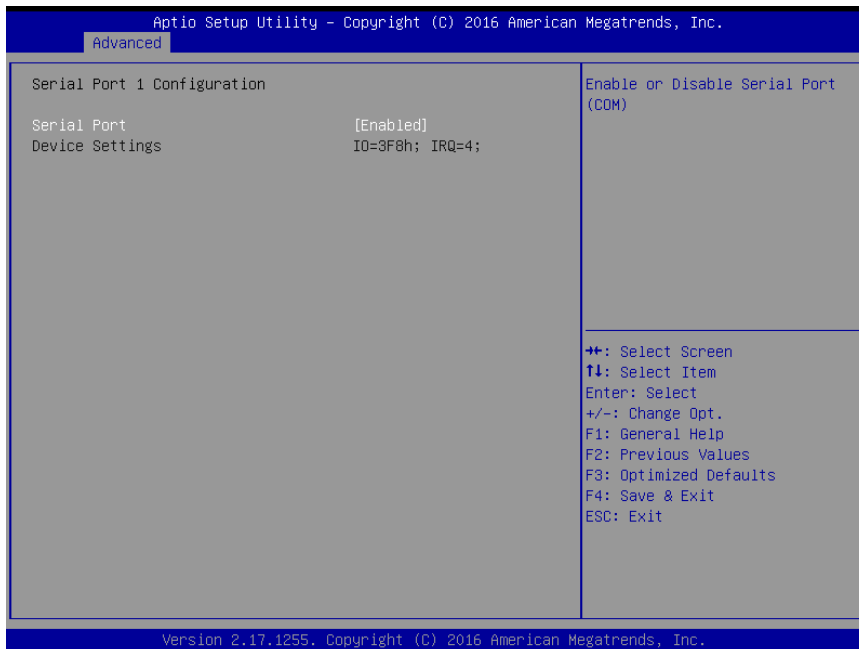

Item	Option	Description
Serial Port	Enabled[Default], Disabled	Enable or Disable Serial Port (COM).

3.6.2.3.2 Serial Port 2 Configuration



Item	Option	Description
Serial Port	Enabled[Default], Disabled	Enable or Disable Serial Port (COM).
UART 232 422 485	UART 232[Default] UART 422 UART 485	Change the Serial Port as RS232/422/485.

3.6.2.4 AMT Configuration

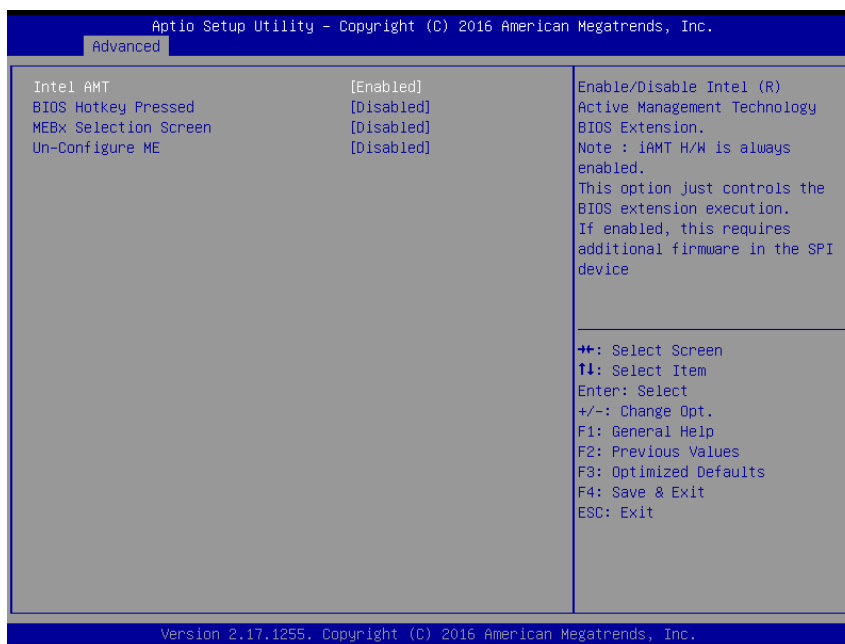

Item	Options	Description
Intel AMT	Disabled Enabled[Default],	Enable/Disable Intel® Active Management Technology BIOS Extension. Note: iAMT H/W is always enabled. This option just controls the BIOS extension execution. If enabled, this requires additional firmware in the SPI device.
BIOS Hotkey Pressed	Disabled[Default] Enabled,	OEMFLag Bit 1: Enable/Disable BIOS hotkey press.
MEBx Selection Screen	Disabled[Default] Enabled,	OEMFLag Bit 2: Enable/Disable MEBx selection screen.
Un-Configure ME	Disabled[Default] Enabled,	OEMFLag Bit 15: Un-Configure ME without password.

3.6.2.5 PCH-FW Configuration

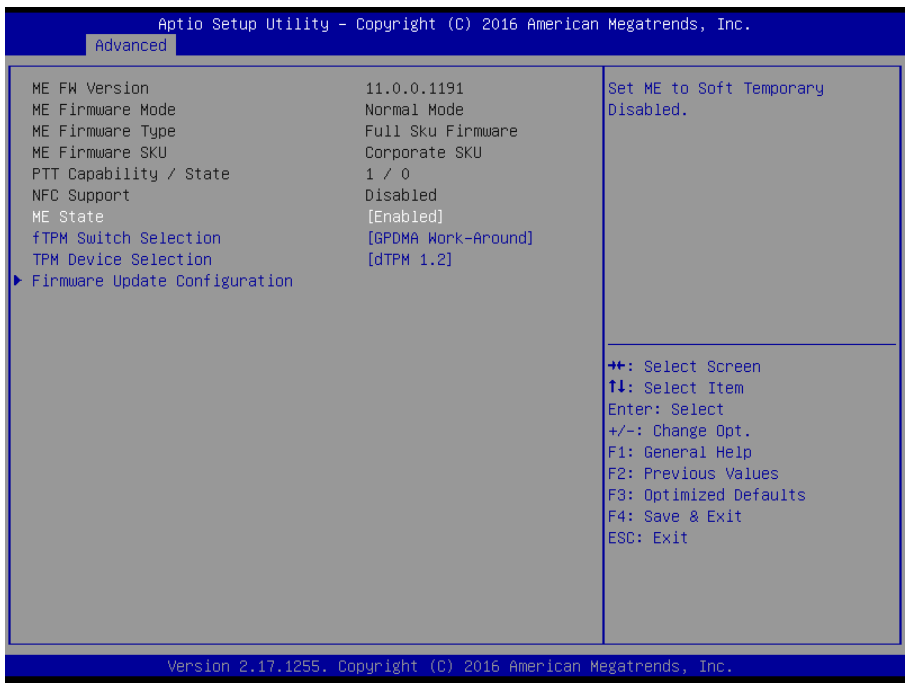

Item	Options	Description
ME State	Disabled Enabled[Default],	Set ME to Soft Temporary Disabled.
fTPM Switch Selection	GPDMA Work-Around[Default], MSFT QFE Solution	Select the desired fTPM solution to be used.
TPM Device Selection	dTPM 1.2[Default], PTT	Selects TPM device: PTT or dTPM. PTT – Enables PTT in SkuMgr dTPM 1.2 – Disables PTT in SkuMgr Warning! PTT/dTPM will be disabled and all data saved on it will be lost.

3.6.2.5.1 Firmware Update Configuration



Item	Option	Description
ME FW Image Re-Flash	Disabled [Default], Enabled	Enable/Disable Me FW Image Re-Flash function.

3.6.2.6 H/W Monitor

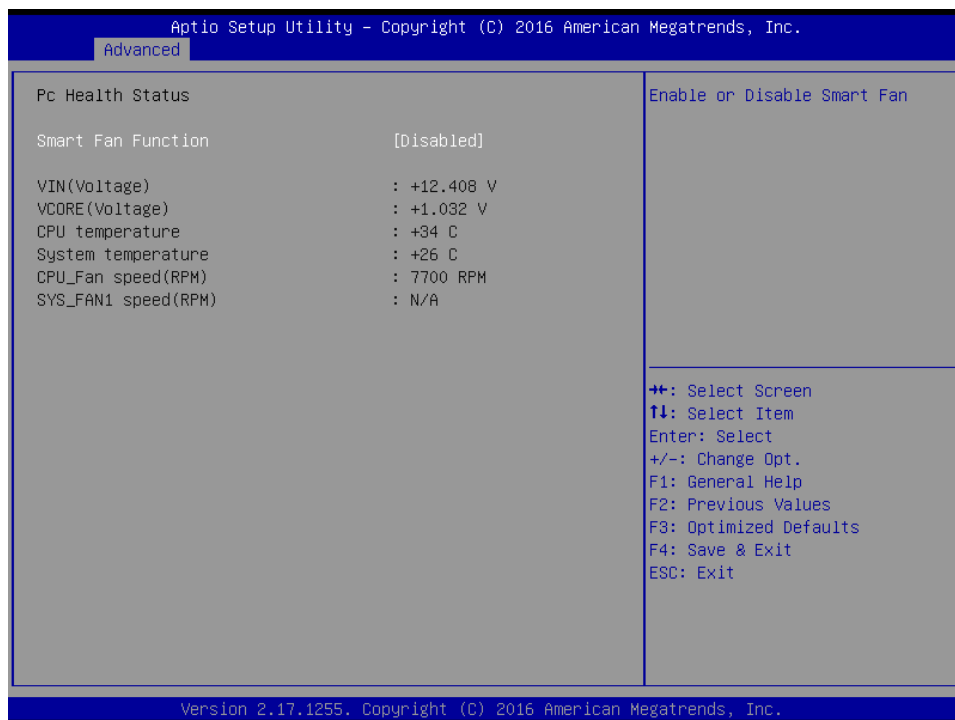

ECM-SKLH User's Manual

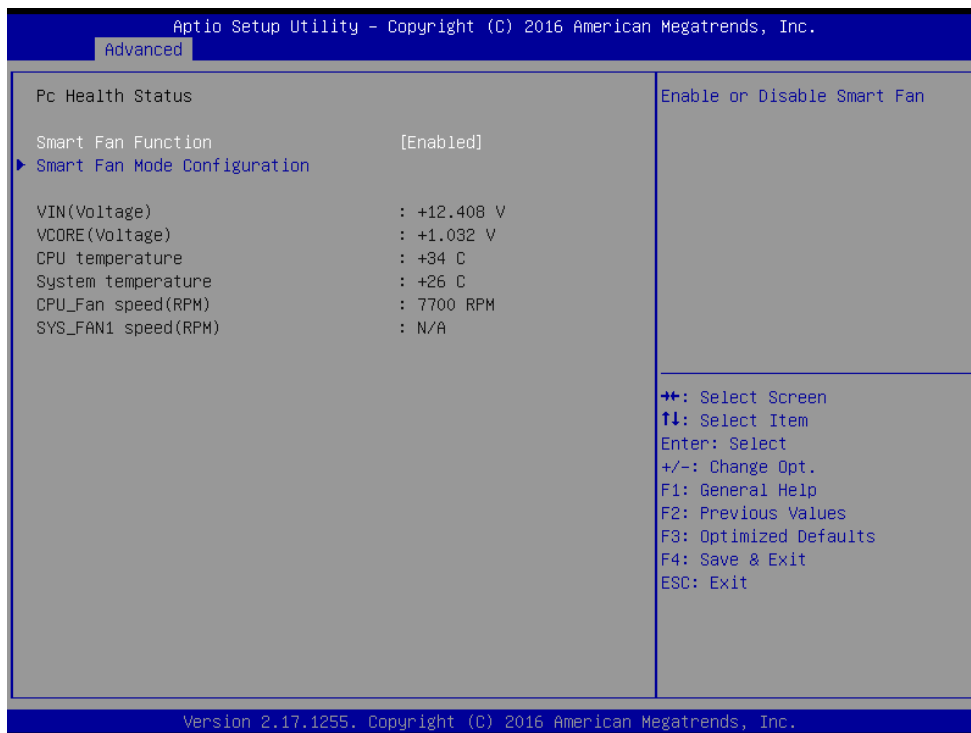

Item	Options	Description
Smart Fan Function	Enabled, Disabled[Default]	Enables or Disables Smart Fan.

3.6.2.6.1 Smart Fan Mode Configuration

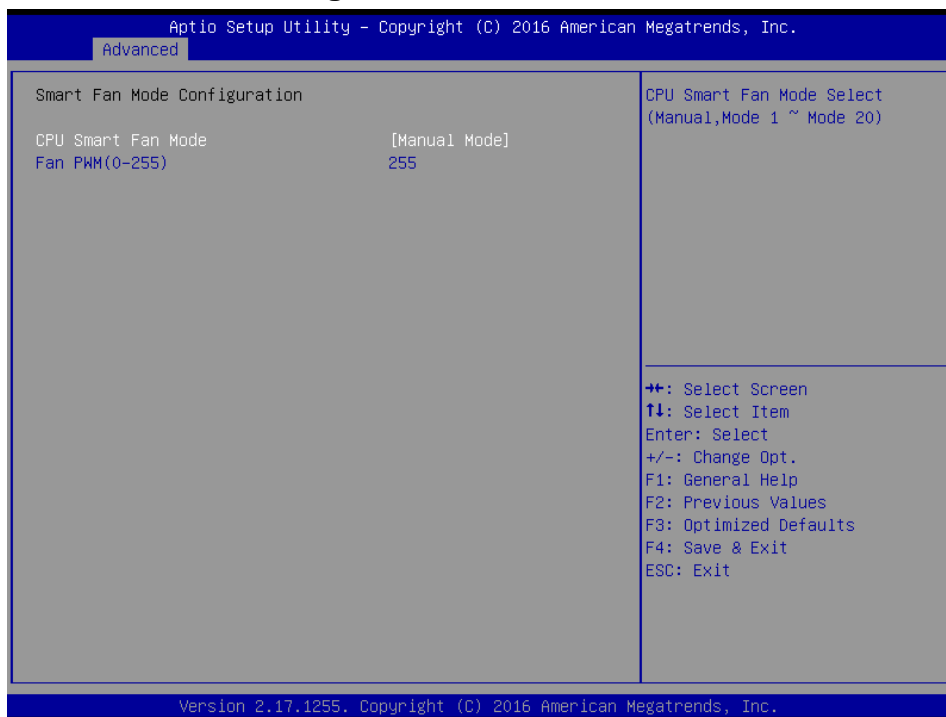

Item	Option	Description
CPU Smart Fan Mode	Manual Mode[Default]/, Mode 01/02/03/04/05	CPU Smart Fan Mode Select (Manual, Mode 1~Mode 20).

	/06/07/08/09/10 /11/12/13/14/15 /16/17/18/19/20	
Fan PWM (0-255)	0-255[Default]	Fan PWM duty (0-255).

3.6.2.7 S5 RTC Wake Settings



Item	Options	Description
Wake system from S5	Disabled[Default], Fixed Time Dynamic Time	Enable or disable System wake on alarm event. Select Fixed Time, system will wake on the hr::min::sec specified. Select Dynamic Time, System will wake on the current time + Increase minute(s).

ECM-SKLH User's Manual

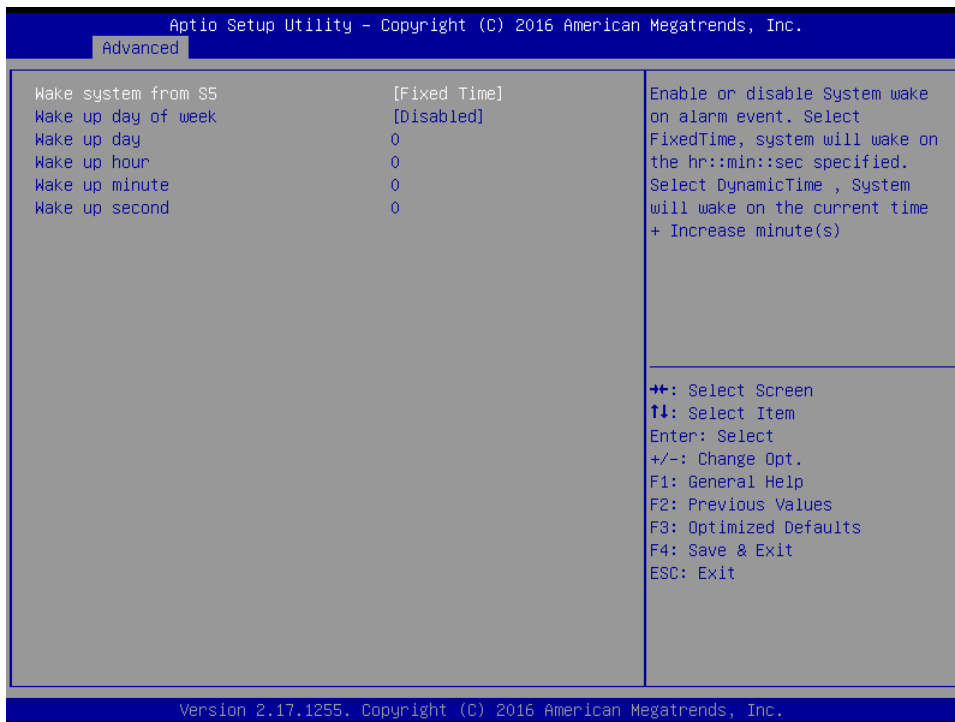

Item	Options	Description
Wake system from S5	Disabled, Fixed Time[Default] Dynamic Time	Enable or disable System wake on alarm event. Select Fixed Time, system will wake on the hr::min::sec specified. Select Dynamic Time, System will wake on the current time + Increase minute(s).
Wake up day of week	Disabled[Default] Monday-Friday Monday-Saturday	Wake up day of week. (Monday-Friday) or (Monday-Saturday).
Wake up day	1-31	Select 0 for daily system wake up 1-31 for which day of the month that you would like the system to wake up.
Wake up hour	0-23	Select 0-23 For example enter 3 for 3am and 15 for 3pm.
Wake up minute	0-23	Select 0-23 For example enter 3 for 3am and 15 for 3pm.
Wake up second	0-23	Select 0-23 For example enter 3 for 3am and 15 for 3pm.

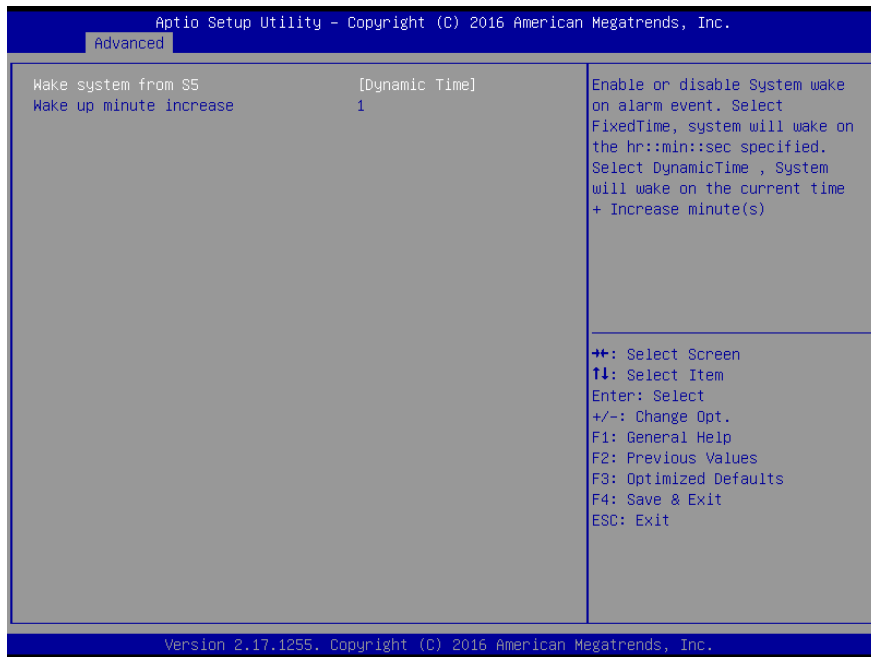

Item	Options	Description
Wake system from S5	Disabled, Fixed Time Dynamic Time[Default]	Enable or disable System wake on alarm event. Select Fixed Time, system will wake on the hr::min::sec specified. Select Dynamic Time, System will wake on the current time + Increase minute(s).
Wake up minute increase	1-5	1-5.

3.6.2.8 Serial Port Console Redirection

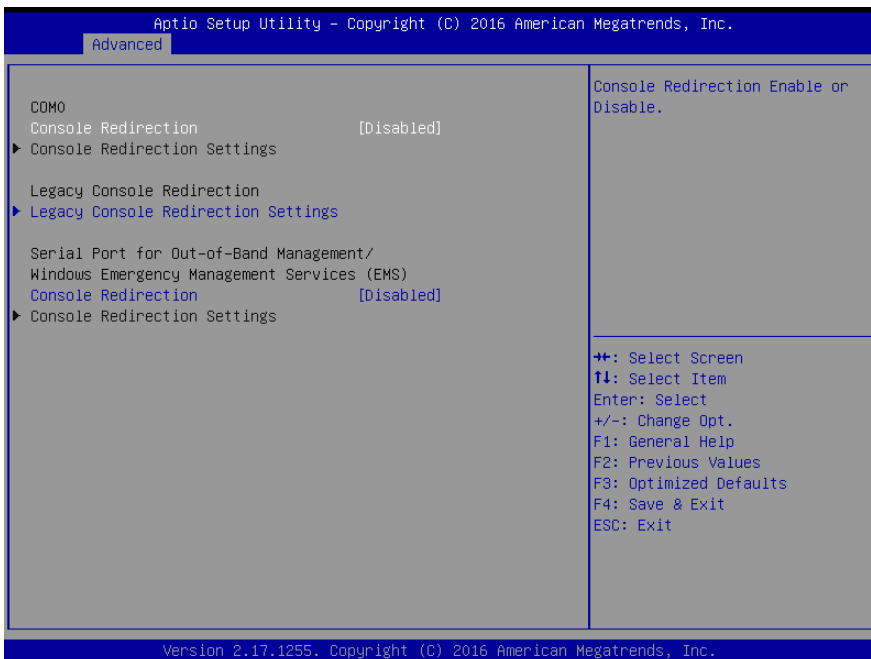

Item	Options	Description
Console Redirection	Disabled[Default], Enabled	Console Redirection Enable or Disable.

3.6.2.9 CPU Configuration

Use the CPU configuration menu to view detailed CPU specification and configure the CPU.

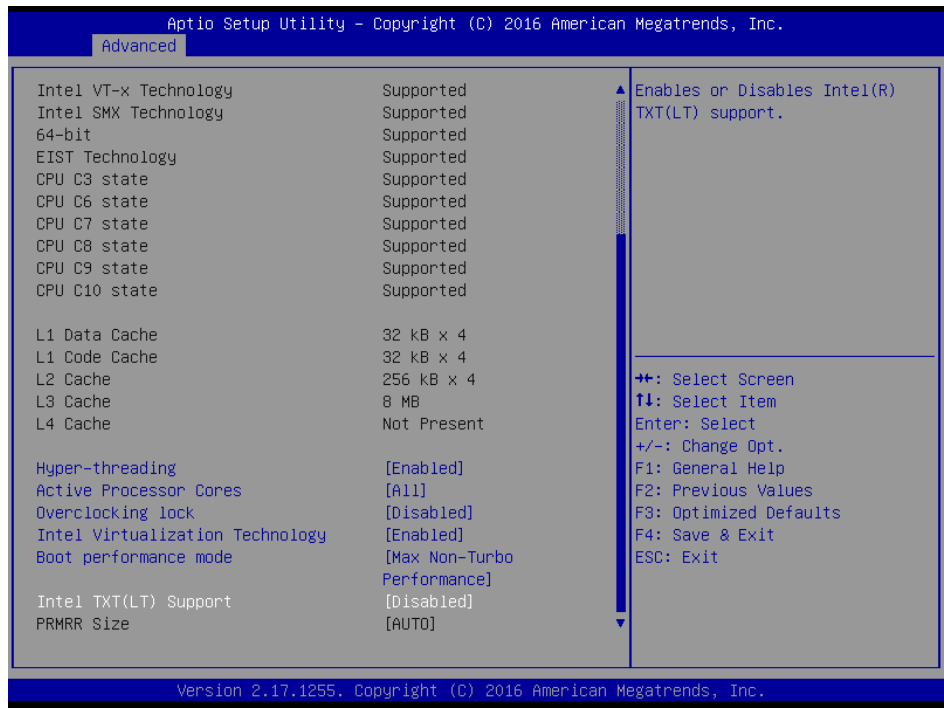
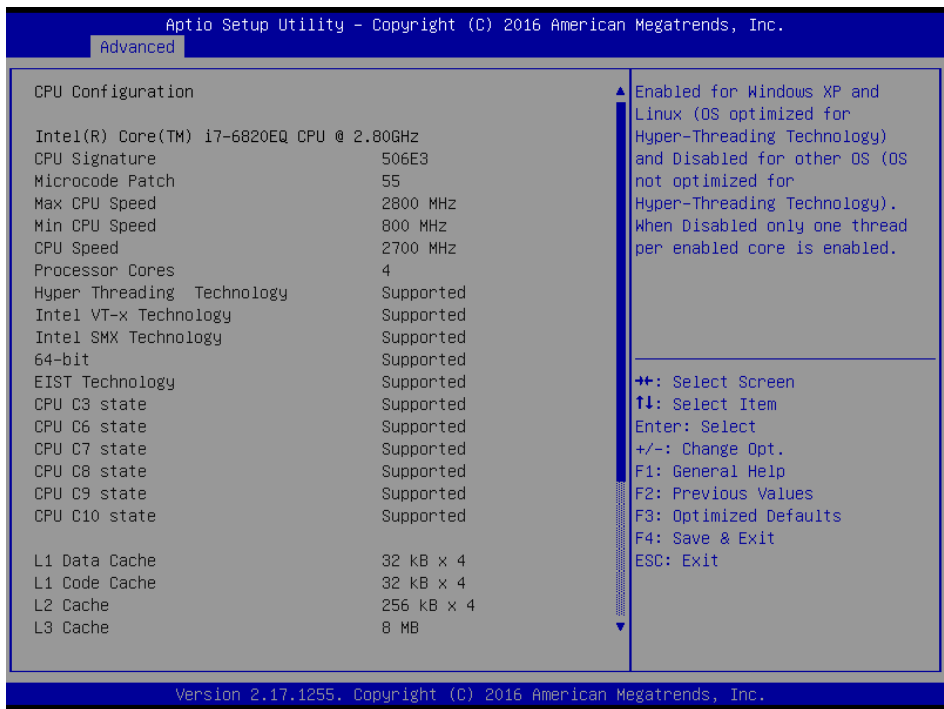

Item	Options	Description
Hyper-threading	Disabled, Enabled[Default]	Enabled for Windows XP and Linux (OS optimized for Hyper- Threading Technology) and Disabled for other OS (OS not optimized for Hyper- Threading

		Technology). When Disabled only one thread per enabled core is enabled.
Active Processor Cores	All[Default] 1 2 3	Number of cores to enable in each processor package.
Overclocking lock	Disabled[Default], Enabled	FLEX_RATIO (194) MSR.
Intel Virtualization Technology	Disabled Enabled[Default]	When enabled, a VMM can utilize the additional hardware capabilities provided by Vanderpool Technology.
Boot performance mode	Max Battery Max Non-Turbo Performance[Default] Turbo Performance	Select the performance state that the BIOS will set before OS handoff.
Intel TXT(LT) Support	Disabled[Default], Enabled	Enables or Disables Intel® TXT(LT) support.

3.6.2.10 Intel TXT Configuration

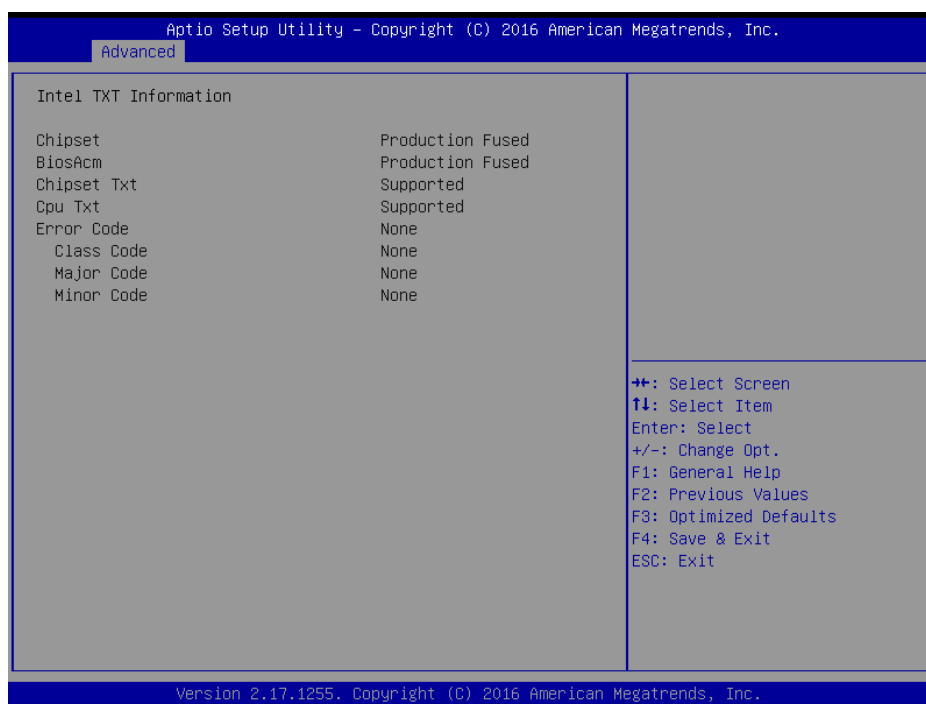

3.6.2.11 SATA Configuration

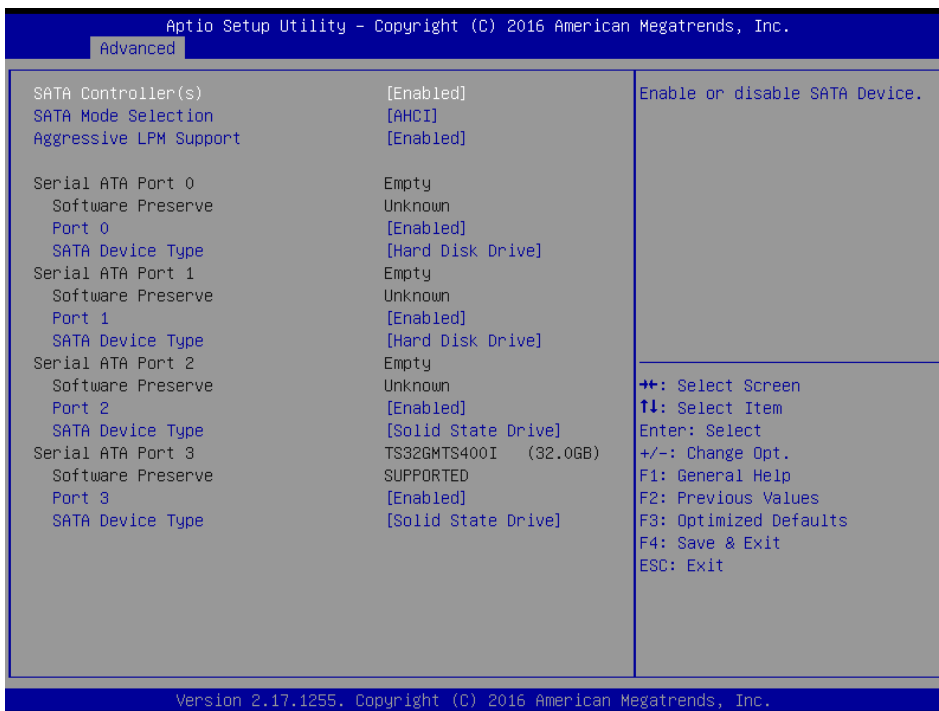

Item	Options	Description
SATA Controller(s)	Enabled[Default] Disabled,	Enable or disable SATA Device.
SATA Mode Selection	AHCI[Default], RAID	Determines how SATA controller(s) operate.
Aggressive LPM Support	Enabled[Default] Disabled	Enable PCH to aggressively enter link power state.
Port 0/1/2/3	Enabled[Default] Disabled,	Enable or Disable SATA Port.
SATA Device Type	Hard Disk Drive [Default] Solid State Drive	Identify the SATA port is connected to Solid State Drive or Hard Disk Drive.

3.6.2.12 Network Stack Configuration



Item	Options	Description
Network Stack	Enabled Disabled[Default]	Enable/Disable UEFI Network Stack.

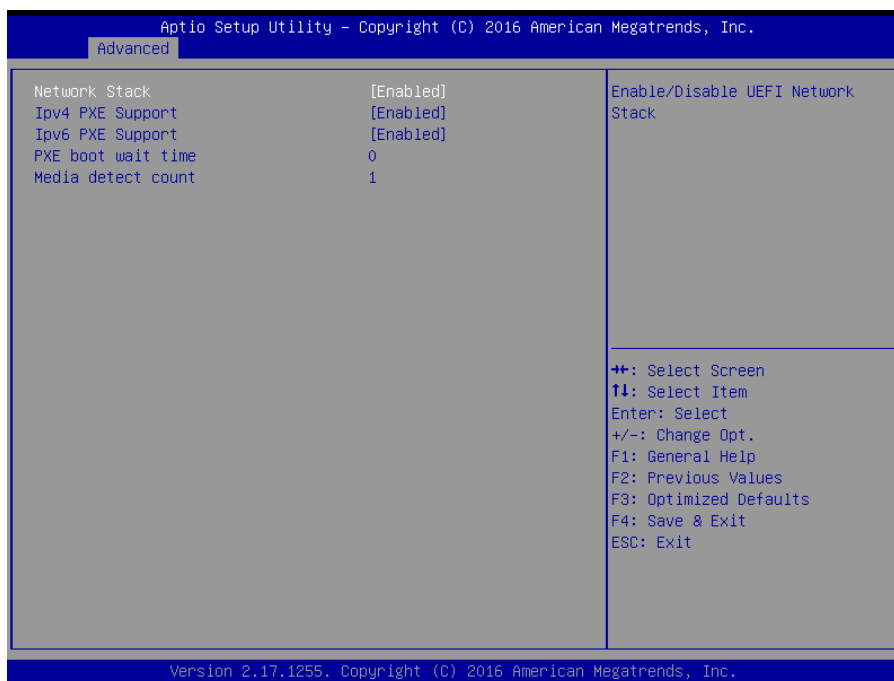

Item	Options	Description
Network Stack	Enabled[Default] Disabled	Enable/Disable UEFI Network Stack.
Ipv4 PXE Support	Enabled[Default] Disabled	Enable Ipv4 PXE Boot Support. If disabled IPV4 PXE boot option will not be created.

ECM-SKLH User's Manual

Ipv6 PXE Support	Enabled[Default] Disabled	Enable Ipv6 PXE Boot Support. If disabled IPV6 PXE boot option will not be created.
PXE boot wait time	0	Wait time to press ESC key to abort the PXE boot.
Media detect count	1	Number of times presence of media will be checked.

3.6.2.13 CSM Configuration

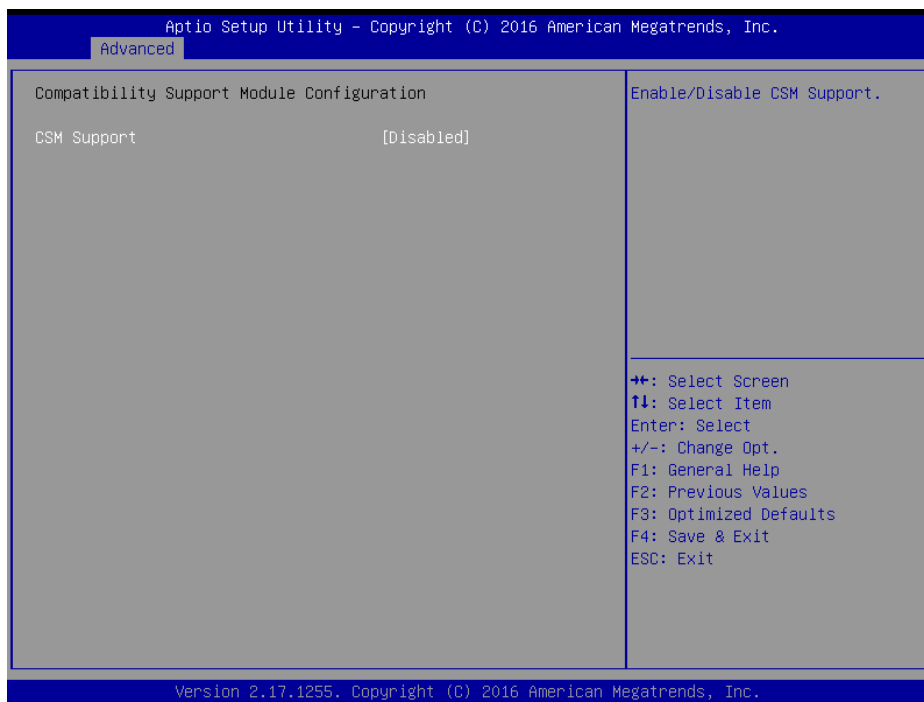

Item	Options	Description
CSM Support	Enabled Disabled[Default]	Enable/Disable CSM Support.

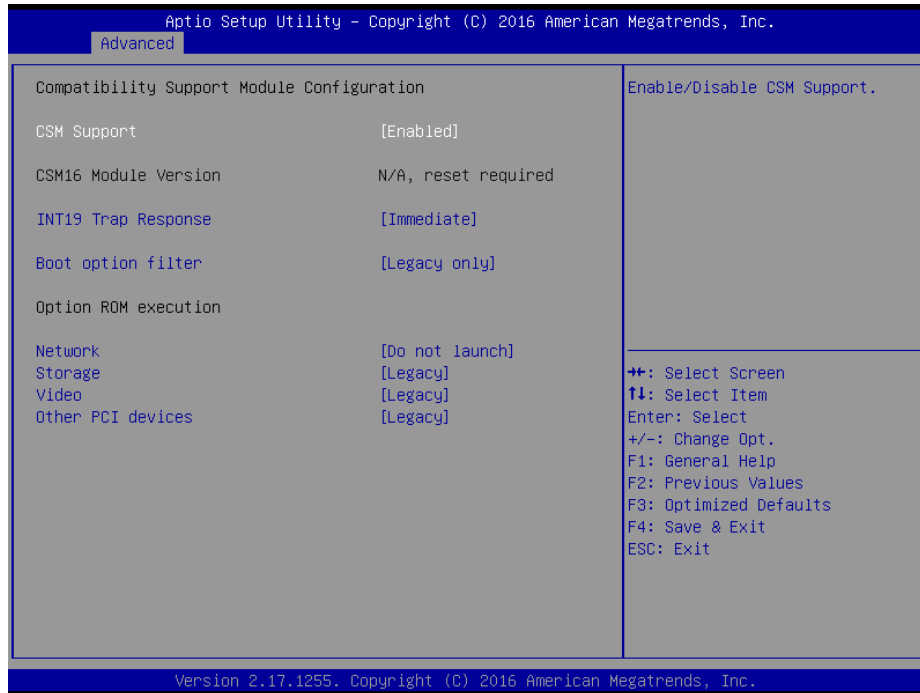

Item	Options	Description
CSM Support	Enabled[Default] Disabled	Enable/Disable CSM Support.
INT19 Trap Response	Immediate[Default] Postponed	BIOS reaction on INT19 trapping by Option ROM: IMMEDIATE – execute the trap right away; POSTPONED – execute the trap during legacy boot.
Boot Option filter	UEFI and Legacy Legacy only[Default] UEFI only	This option controls Legacy/UEFI ROMs priority.
Network	Do not launch[Default] UEFI Legacy	Controls the execution of UEFI and Legacy PXE OpROM.
Storage	Do not launch UEFI Legacy[Default]	Controls the execution of UEFI and Legacy Storage OpROM.
Video	Do not launch UEFI Legacy[Default]	Controls the execution of UEFI and Legacy Video OpROM.
Other PCI devices	Do not launch UEFI Legacy[Default]	Determines OpROM execution policy for devices other than Network, Storage, or Vide.

3.6.2.14 USB Configuration

The USB Configuration menu helps read USB information and configures USB settings.

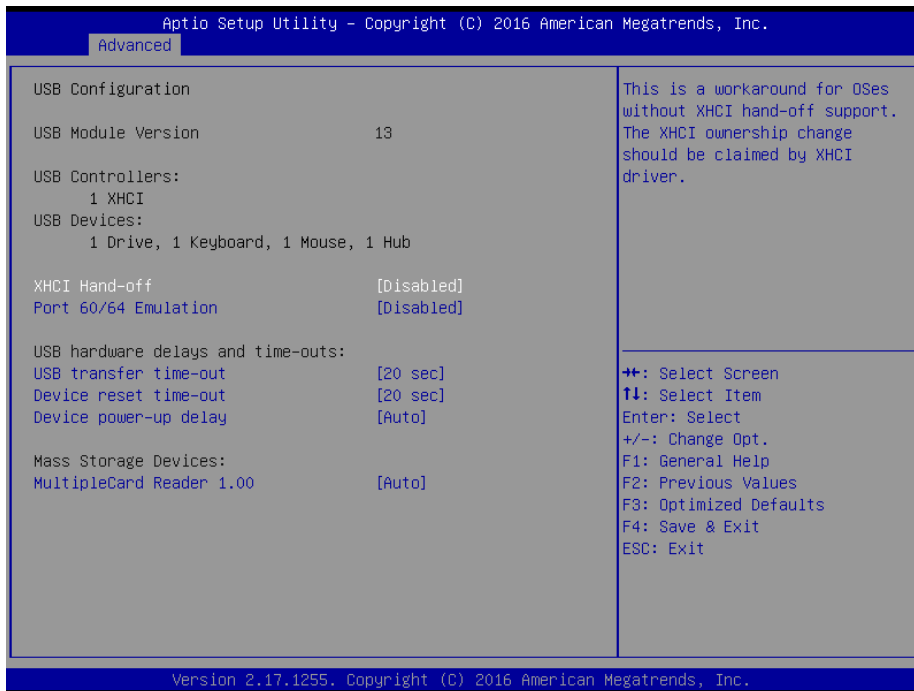

Item	Options	Description
XHCI Hand-off	Enabled Disabled[Default]	This is a workaround for OSeW without XHCI hand-off support. The XHCI ownership change should be claimed by XHCI driver.
Port 60/64 Emulation	Enabled Disabled[Default]	Enable I/O port 60h/64h emulation support. This should be enabled for the complete USB keyboard legacy support for non-USB aware OSeS.
USB transfer time-out	1 sec 5 sec 10 sec 20 sec[Default]	The time-out value for Control, Bulk, and Interrupt transfers.
Device reset time-out	10 sec 20 sec[Default] 30 sec 40 sec	USB mass storage device Start Unit command time-out.
Device power-up delay	Auto[Default] Manual	Maximum time the device will take before it properly reports itself to the Host Controller. 'Auto' uses default value: for a Root port it is 100ms, for a Hub port the delay is taken form Hub descriptor.
Mass Storage Devices	Auto[Default] Floppy Forced FDD Hard Disk CD-ROM	Mass storage device emulation type. 'AUTO' enumerates devices according to their media format. Optical drives are emulated as 'CDROM', drives with no media will be emulated according to a drive type.

3.6.3 Chipset

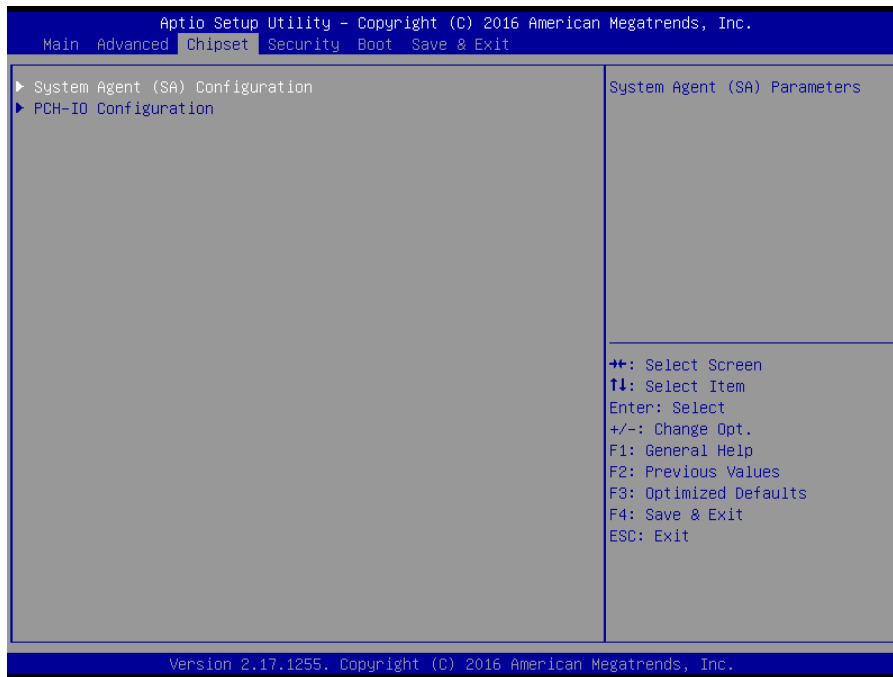

3.6.3.1 System Agent (SA) Configuration

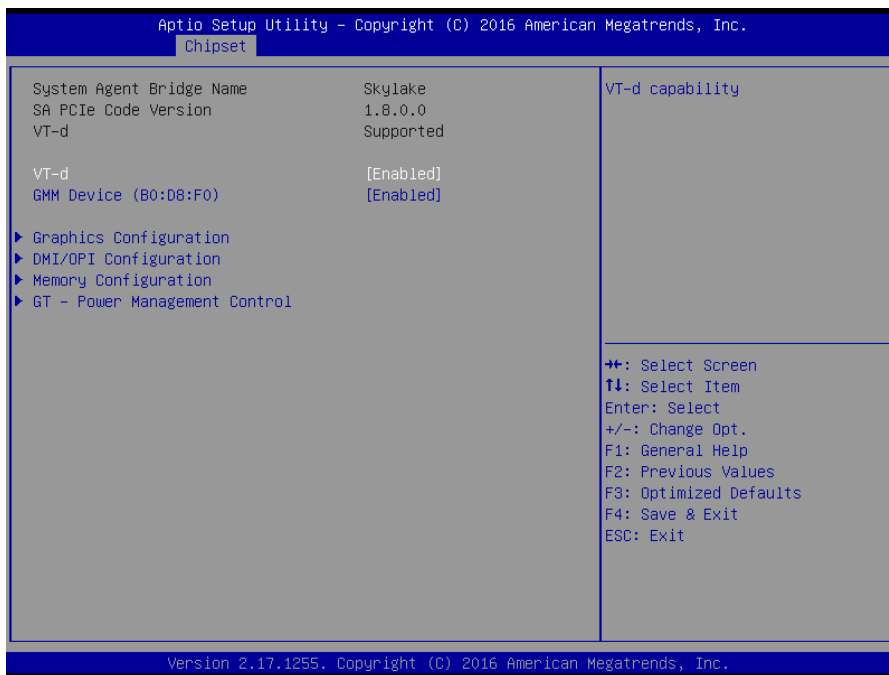

Item	Option	Description
VT-d	Enabled[Default] Disabled	VT-d capability.
GMM Device (B0:D8:F0)	Enabled[Default] Disabled	Enable/Disable SA GMM Device.

3.6.3.1.1 Graphics Configuration

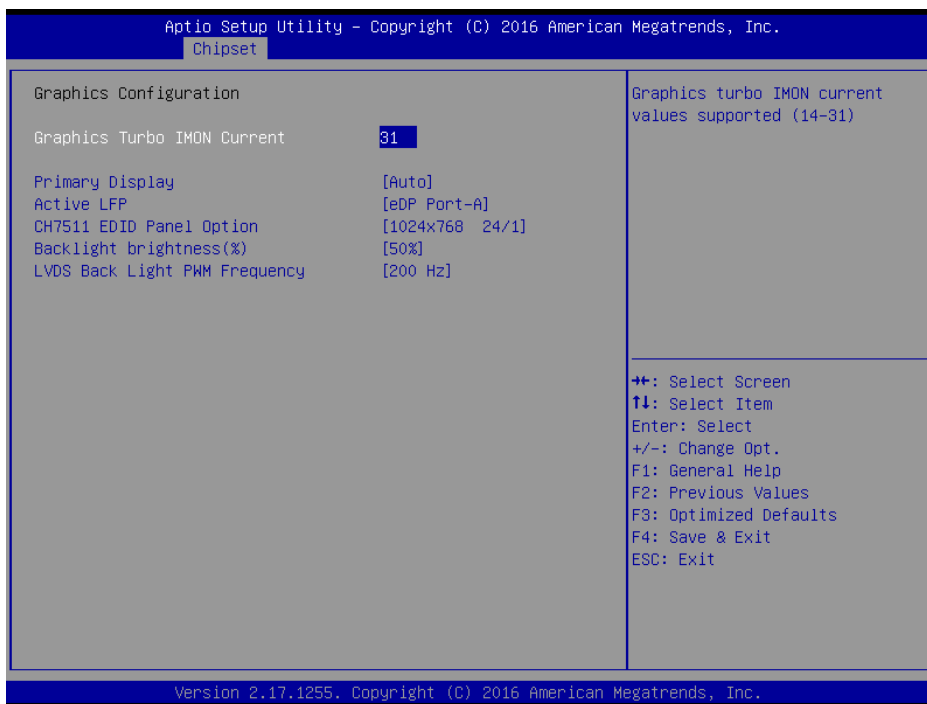

Item	Option	Description
Graphics Turbo IMON Current	14-31	Graphics turbo IMON current values supported (14-31).
Primary Display	Auto[Default] IGFX PCIE	Select which of IGFX/PEG/PCI Graphics device should be Primary Display Or select SG for Switchable Gfx.
Active LFP	No LVDS eDP Port-A[Default]	Configuring LFP usage.
CH7511 EDID Panel Option	1024x768 24/1[Default] 800x600 18/1 1024x768 18/1 1366x768 18/1 1024x600 18/1 1280x800 18/1 1920x1200 24/2 640x480 18/1 800x480 18/1 1920x1080 18/2 1280x1024 24/2 1440x900 18/2 1600x1200 24/2 1366x768 24/1 1920x1080 24/2 1680x1050 24/2	Port1-EDP to LVDS (Chrotel 7511) Panel EDID Option.
Backlight brightness (%)	00% 25% 50%[Default]	Select LVDS back light PWM duty.

	75% 100%	
LVDS Back Light PWM Frequency	200 Hz[Default] 300 Hz 400 Hz 500 Hz 700 Hz 1k 2k 3k 5k 10k 20k	Select LVDS back light PWM Frequency.

3.6.3.1.2 DMI/OPI Configuration

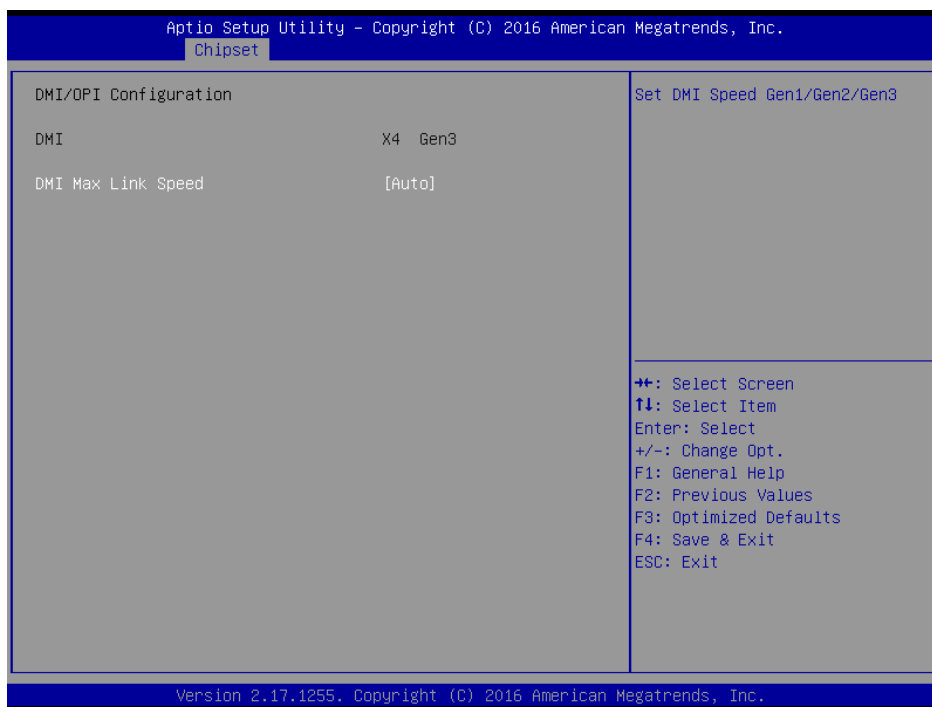

Item	Option	Description
DMI Max Link Speed	Auto[Default] Gen1 Gen2 Gen3	Set DMI Speed Gen1/Gen2/Gen3.

3.6.3.1.3 Memory Configuration



Item	Option	Description
Maximum Memory Frequency	Auto[Default] /1067/1200/1333/1400/1600 /1800/1867/2000/2133/2200 /2400/2600/2667/2800/2933 /3000/3200	Maximum Memory Frequency Selections in Mhz.
Max TOLUD	Dynamic[Default] /1GB/1.25GB/1.5GB/1.75GB /2GB/2.25GB/2.5GB/2.75GB /3GB/3.25GB/3.5GB	Maximum Value of TOLUD. Dynamic assignment would adjust TOLUD automatically based on largest MMIO length of installed graphic controller.
SA GV	Disabled Fixed Low Fixed High Enabled[Default]	System Agent Geyserville. Fixed Low/High: SA GV disabled, MR only runs tasks from Low or High point.
SA GV Low Freq	MRC default[Default] /1067/1200/1333/1400/1600 /1800/1867	System Agent Geyserville. Set frequency for low point. Default 1067 for LPDDR3/DDR3, 1333 for DDR4.

3.6.3.1.4 GT- Power Management Control

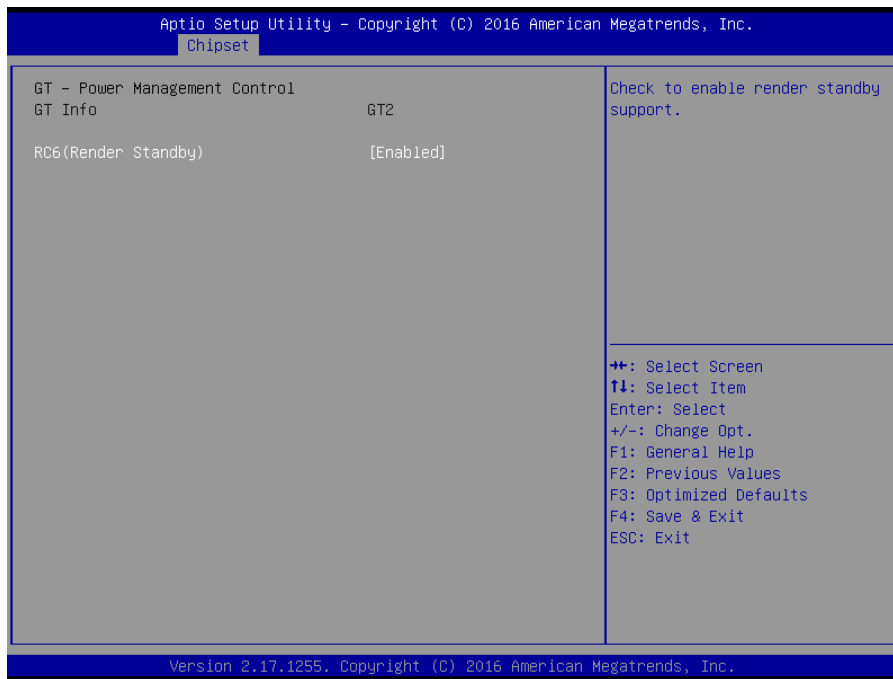

Item	Option	Description
RC6 (Render Standby)	Enabled[Default] Disabled	Check to enable render standby support.

3.6.3.2 PCH-IO Configuration

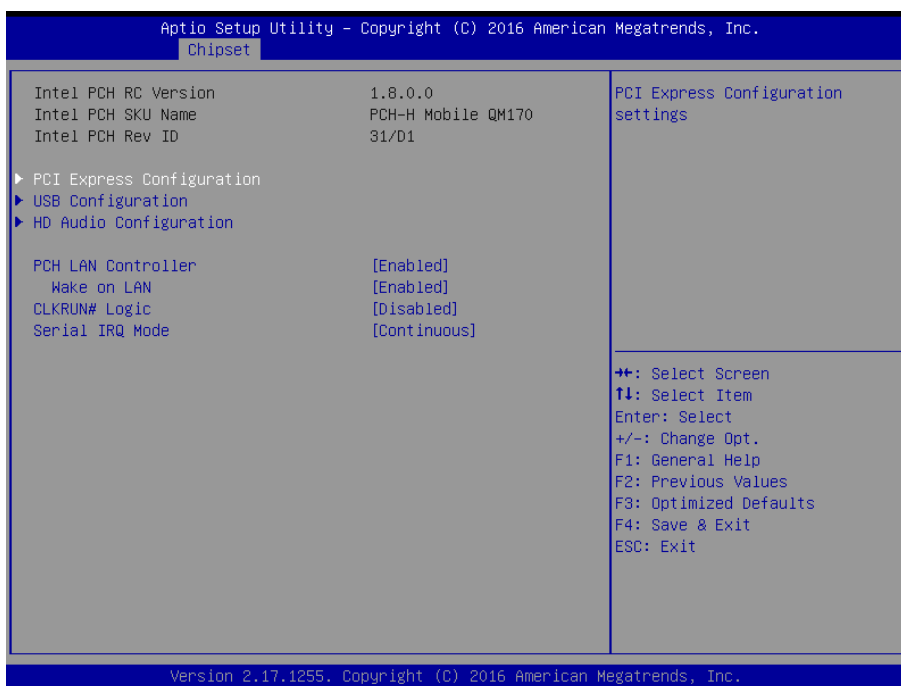

ECM-SKLH User’s Manual

Item	Option	Description
PCH LAN Controller	Disabled Enabled[Default]	Enable or disable onboard NIC.
Wake on LAN	Disabled Enabled[Default]	Enable or disable integrated LAN to wake the system.
CLKRUN# Logic	Disabled[Default] Enabled	Enable the CLKRUN# logic to stop the PCI clocks.
Serial IRQ Mode	Quiet Continuous[Default]	Configure Serial IRQ Mode.

3.6.3.2.1 PCI Express Configuration

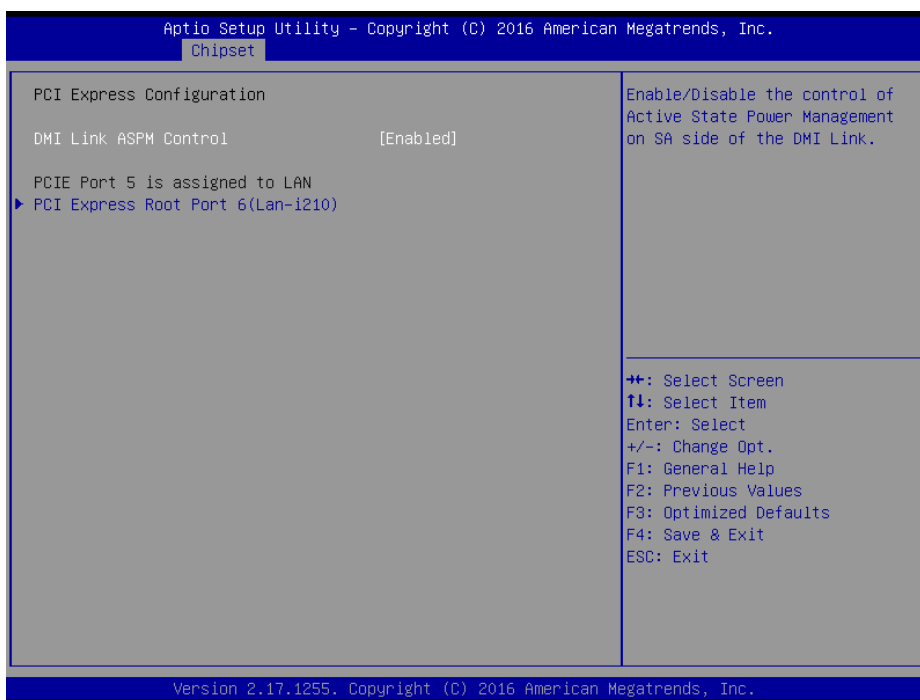

Item	Option	Description
DMI Link ASPM Control	Disabled Enabled[Default]	Enable/Disable the control of Active State Power Management on SA side of the DMI Link.

3.6.3.2.1.1 PCI Express Root Port6 (Lan-i210)

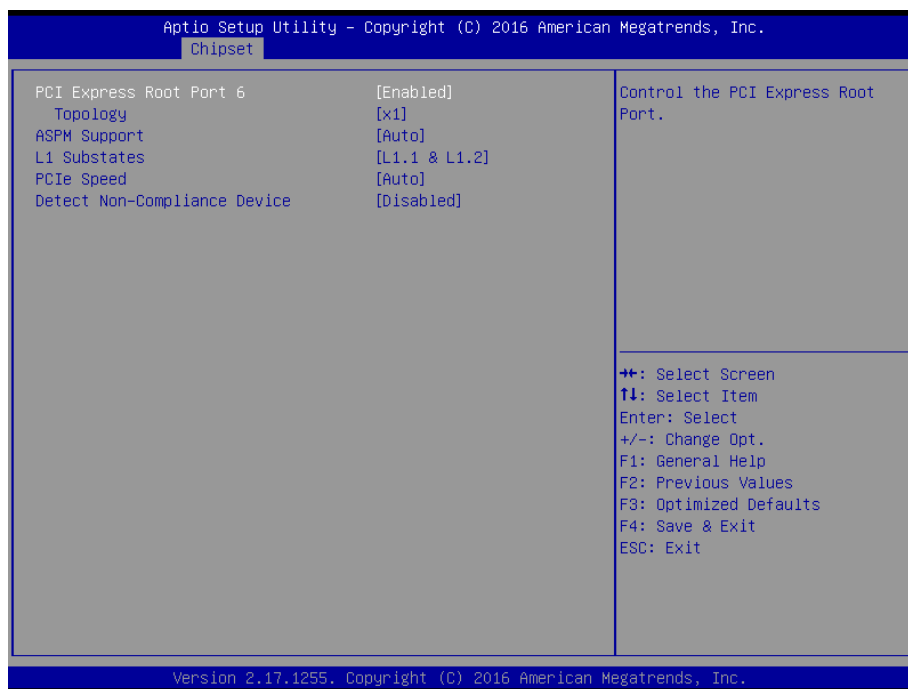

Item	Option	Description
PCI Express Root Port 6	Enabled[Default], Disabled	Control the PCI Express Root Port.
Topology	Unknown x1[Default], x4 Sata Express M2	Identify the SATA Topology if it is Default or ISATA or Flex or DirectConnect or M2.
ASPM Support	Disabled L0s L1 L0sL1 Auto[Default],	Set the ASPM Level: Force L0s – Force all links to L0s State AUTO – BIOS auto configure DISABLE – Disables ASPM.
L1 Substates	Disabled L1.1 L1.2 L1.1 & L1.2[Default],	PCI Express L1 Substates settings.
PCIe Speed	Auto[Default] Gen1 Gen2 Gen3	Select PCI Express port speed.
Detect Non-Compliance Device	Disabled[Default], Enabled	Detect Non-Compliance PCI Express Device. If enable, it will take more time at POST time.

3.6.3.2.2 USB Configuration

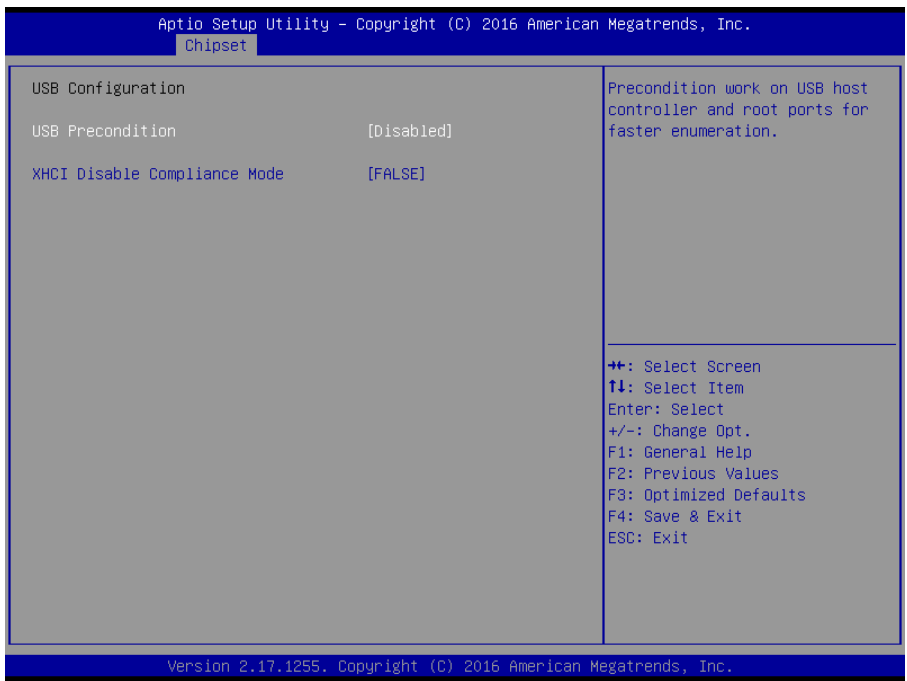

Item	Option	Description
USB Precondition	Enabled Disabled[Default],	Precondition work on USB host controller and root ports for faster enumeration.
XHCI Disable Compliance Mode	FALSE[Default], TRUE	Option to disable Compliance Mode. Default is FALSE to not disable Compliance Mode. Set TRUE to disable Compliance Mode.

3.6.3.2.3 HD Audio Configuration

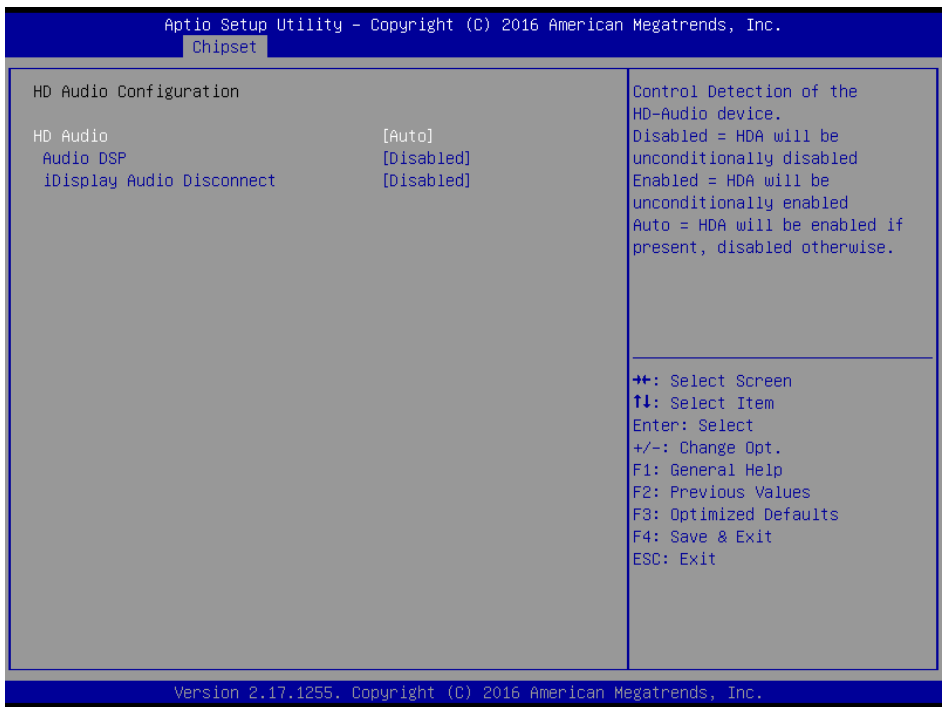

Item	Option	Description
HD Audio	Disabled Enabled Auto[Default],	Control Detection of the HD-Audio device. Disable = HDA will be unconditionally disabled Enabled = HDA will be unconditionally enabled Auto = HDA will be enabled if present, disabled otherwise.
Audio DSP	Disabled[Default] Enabled	Enable/Disable Audio DSP.
iDisplay Audio Disconnect	Disabled[Default] Enabled	Disconnects SDI2 signal to hide/disable iDisplay Audio Code.

3.6.4 Security

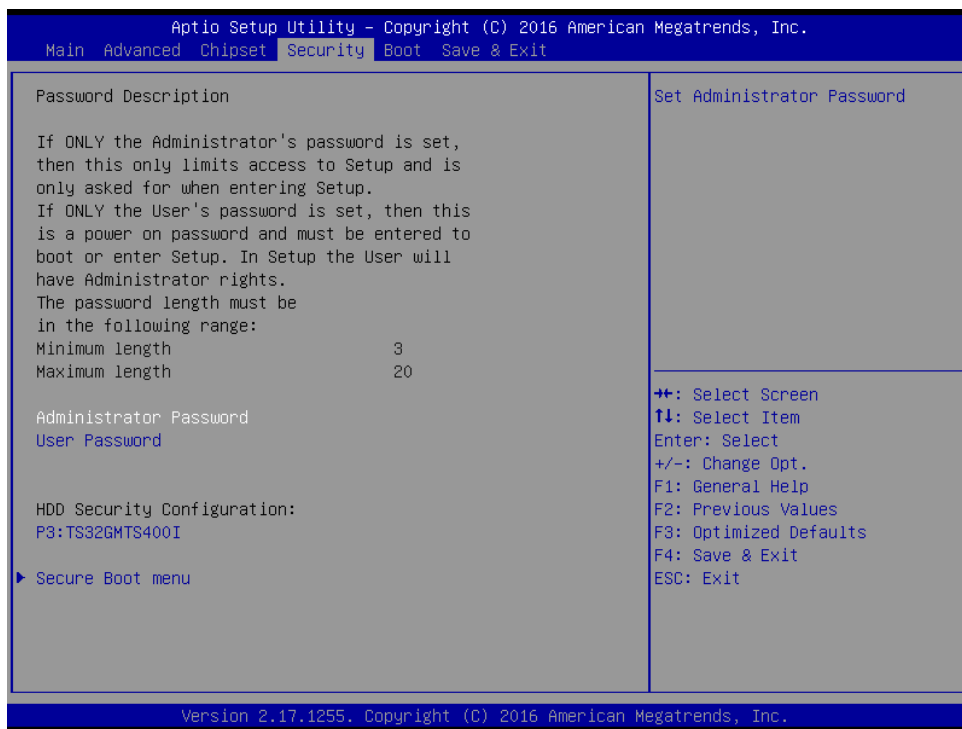

- **Administrator Password**

Set setup Administrator Password

- **User Password**

Set User Password

3.6.4.1 Secure Boot menu

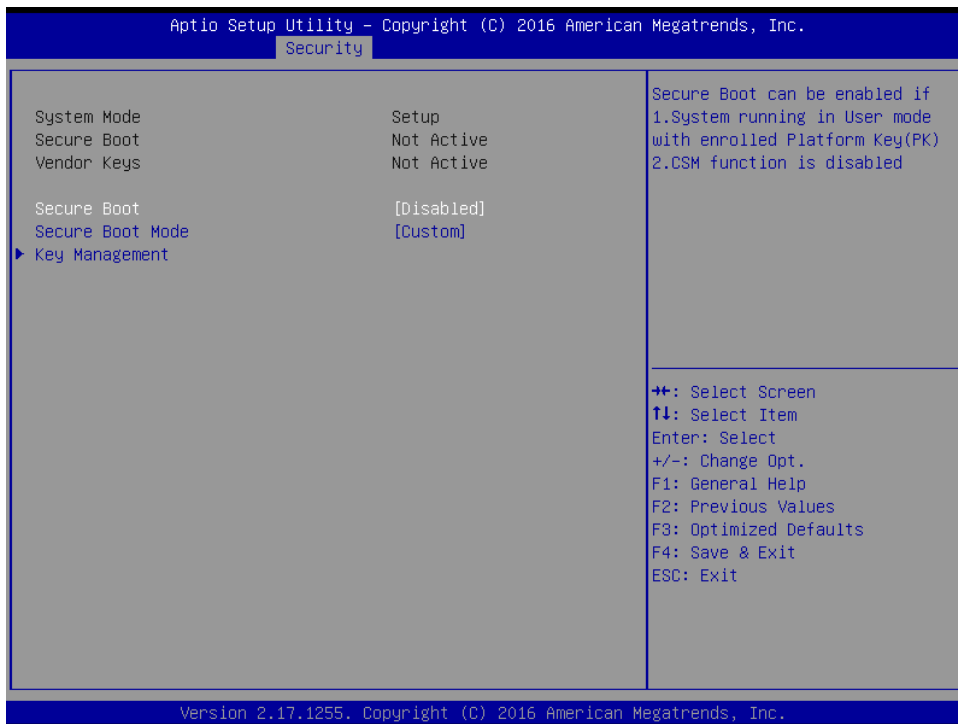

Item	Option	Description
Secure Boot	Disabled[Default] Enabled	Secure Boot can be enabled if 1. System running in User mode with enrolled Platform Key(PK) 2. CSM function is disabled.
Secure Boot Mode	Standard Custom[Default]	Secure Boot mode selector. 'Custom' Mode enables users to change Image Execution policy and manage Secure Boot Keys.

3.6.5 Boot



Item	Option	Description
Setup Prompt Timeout	1~ 65535	Number of seconds to wait for setup activation key. 65535(0xFFFF) means indefinite waiting.
Bootup NumLock State	On[Default] Off	Select the Keyboard NumLock state
Quiet Boot	Disabled[Default] Enabled	Enables or disables Quiet Boot option
Fast Boot	Disabled[Default] Enabled	Enables or disables boot with initialization of a minimal set of devices required to launch active boot option. Has no effect for BBS boot options.
Boot Option #1/2	Set the system boot order.	

3.6.6 Save and exit

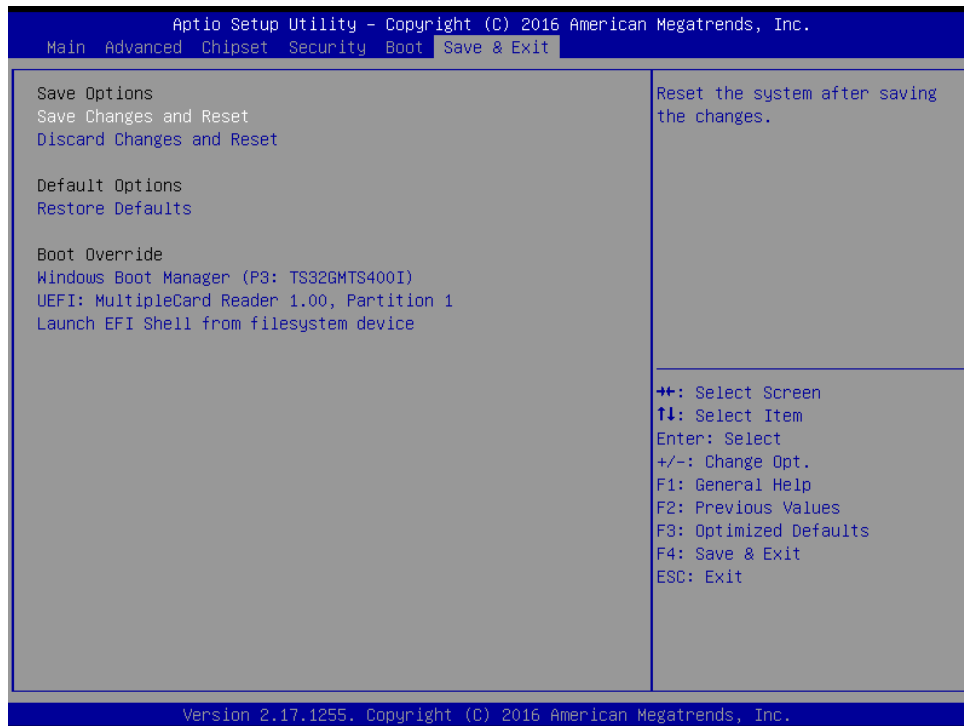

3.6.6.1 Save Changes and Reset

Reset the system after saving the changes.

3.6.6.2 Discard Changes and Reset

Any changes made to BIOS settings during this session of the BIOS setup program are discarded. The setup program then exits and reboots the controller.

3.6.6.3 Restore Defaults

This option restores all BIOS settings to the factory default. This option is useful if the controller exhibits unpredictable behavior due to an incorrect or inappropriate BIOS setting.

3.6.6.4 Launch EFI Shell from filesystem device

Attempts to Launch EFI Shell application (Shellx64.efi) from one of the available filesystem devices.

4. Drivers Installation



Note: Installation procedures and screen shots in this section are for your reference and may not be exactly the same as shown on your screen.

4.1 Install Chipset Driver

Insert the Supporting DVD-ROM to DVD-ROM drive, and it should show the index page of Avalue's products automatically. If not, locate Index.htm and choose the product from the menu left, or link to `\Driver_Chipset\Intel\ECM-SKLH`.



Note: The installation procedures and screen shots in this section are based on Windows 10 operation system. If the warning message appears while the installation process, click Continue to go on.

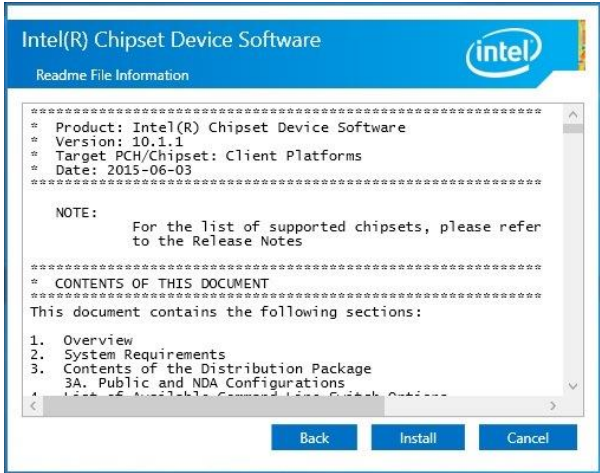

Step 3. Click **Install**.



Step1. Click **Next**.



Step 4. Setup completed.



Step 2. Click **Accept**.

4.2 Install ME Driver

Insert the Supporting DVD-ROM to DVD-ROM drive, and it should show the index page of Avalue's products automatically. If not, locate Index.htm and choose the product from the menu left, or link to \Utility\ECM-SKLH_ME.



Note: The installation procedures and screen shots in this section are based on Windows 10 operation system. If the warning message appears while the installation process, click Continue to go on.

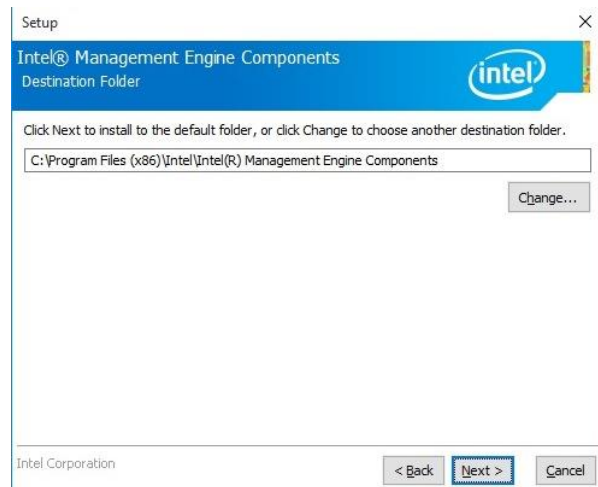

Step 3. Click **Next** to continue installation.

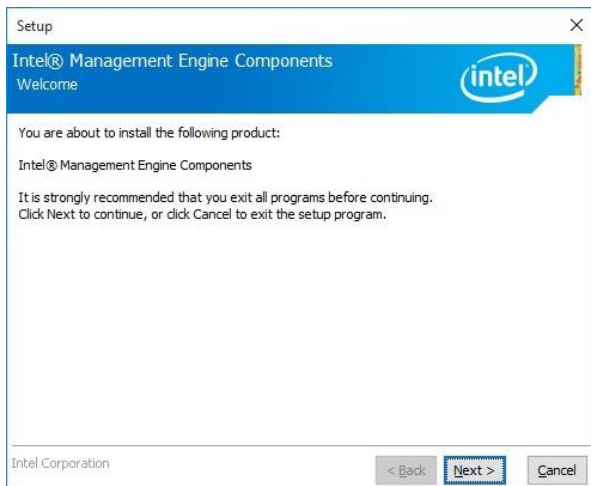

Step1. Click **Next** to start installation.



Step 4. Click **Finish** to complete setup.

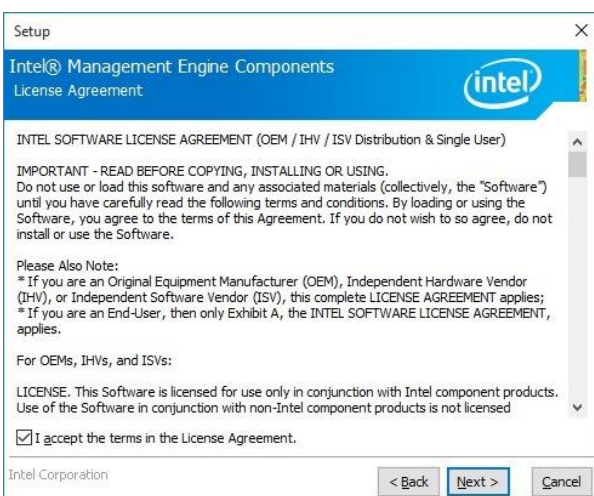

Step 2. Click **Next**.

4.3 Install VGA Driver

Insert the Supporting DVD-ROM to DVD-ROM drive, and it should show the index page of Avalue's products automatically. If not, locate Index.htm and choose the product from the menu left, or link to **VGA\ECM-SKLH**.



Note: The installation procedures and screen shots in this section are based on Windows 10 operation system.

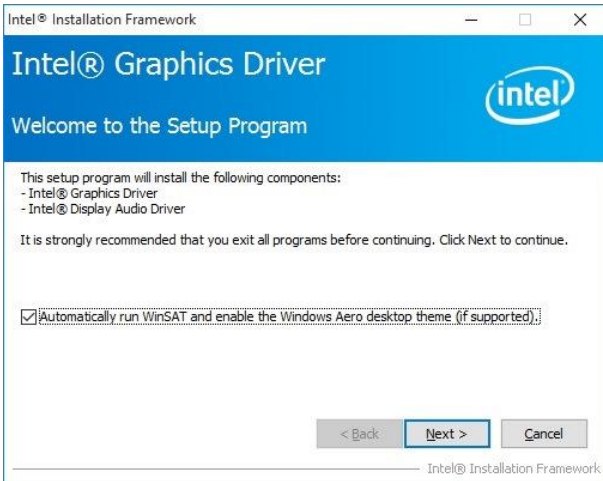

Step 1. Click **Next** to continue installation.

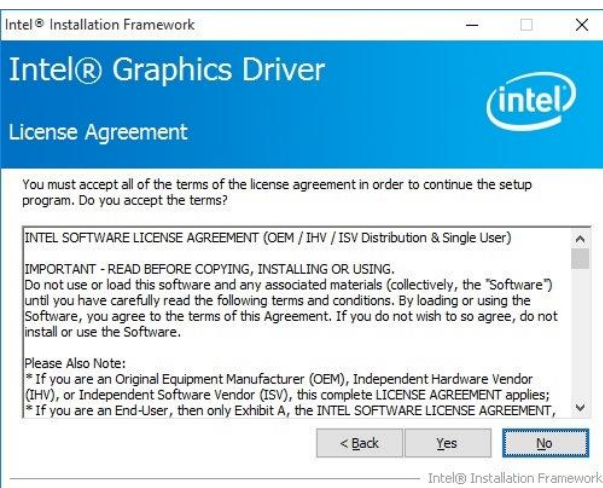

Step 2.
Click **Yes** to accept license agreement.

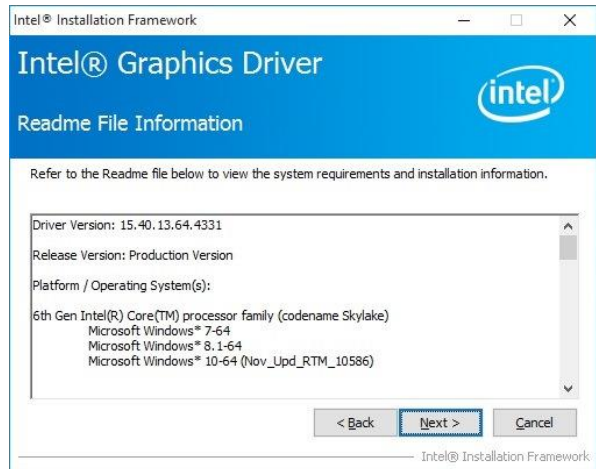

Step 3. Click **Next**.

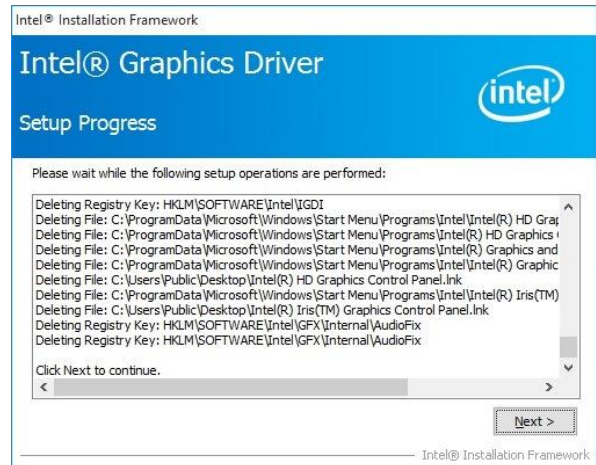

Step 4. Click **Next**.

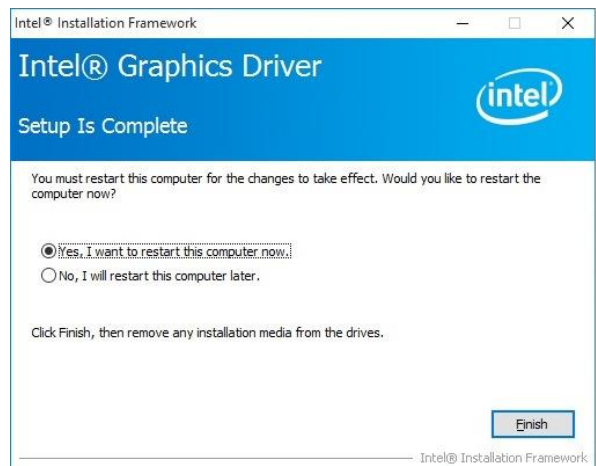

Step 5. Click **Finish** to complete setup.

4.4 Install Audio Driver (For Realtek ALC233)

Insert the Supporting CD-ROM to CD-ROM drive, and it should show the index page of Avalue's products automatically. If not, locate Index.htm and choose the product from the menu left, or link to **\\Driver_Audio\Realtek\ALC233\ECM-SKLH_Audio**.



Note: The installation procedures and screen shots in this section are based on Windows 10 operation system.

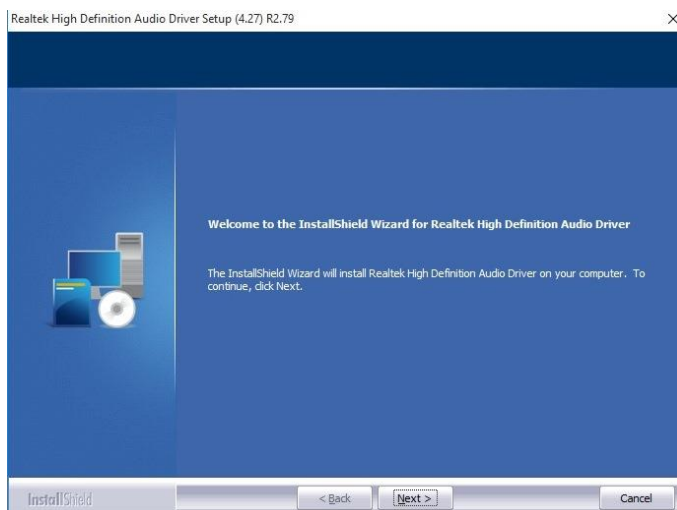

Step 1. Click **Next** to continue setup.

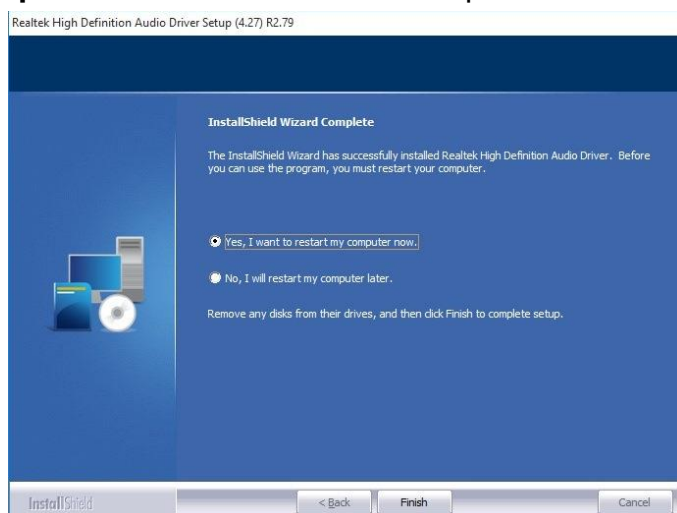

Step 2. Click **Finish** to complete the setup.

4.5 Install Ethernet Driver

Insert the Supporting DVD-ROM to DVD-ROM drive, and it should show the index page of Avalue's products automatically. If not, locate Index.htm and choose the product from the menu left, or link to `\\Driver_Gigabit\Intel\I210AT_I219LM\ECM-SKLH_LAN`.



Note: The installation procedures and screen shots in this section are based on Windows 10 operation system.



Step 3. Click Next.



Step 1. Click Next.

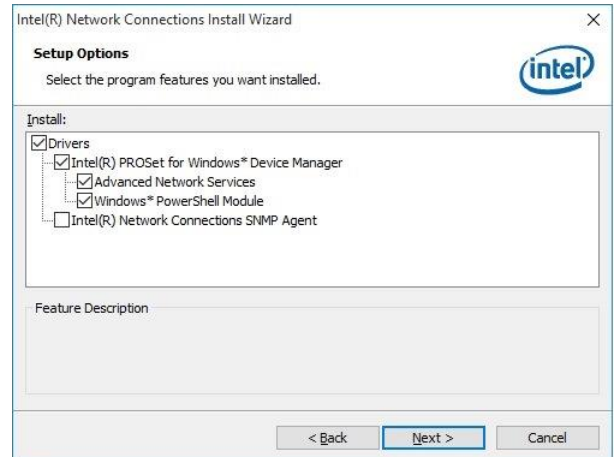

Step 4. Click Next.



Step 2. Click Next to proceed.



Step 5. Click Yes.

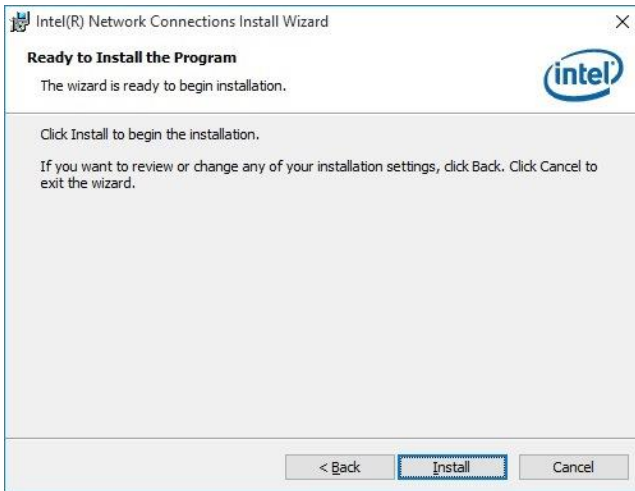

Step 6. Click **Install**.

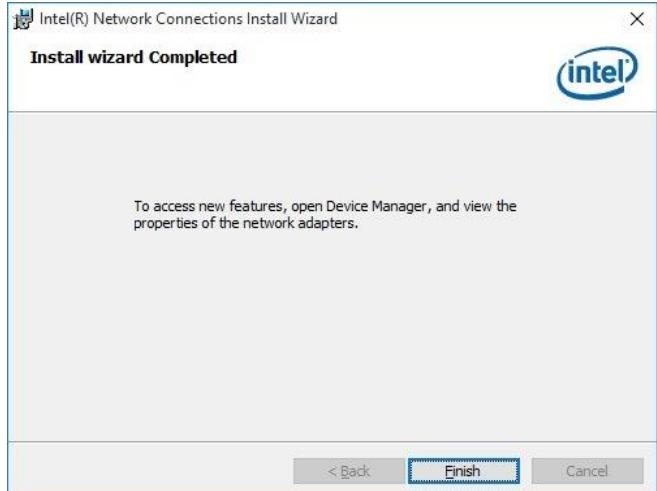

Step 7. Click **Finish** to complete the setup.

4.6 Install RST Driver

Insert the Supporting DVD-ROM to DVD-ROM drive, and it should show the index page of Avalue's products automatically. If not, locate Index.htm and choose the product from the menu left, or link to \Utility\ECM-SKLH_RST.



Note: The installation procedures and screen shots in this section are based on Windows 10 operation system.

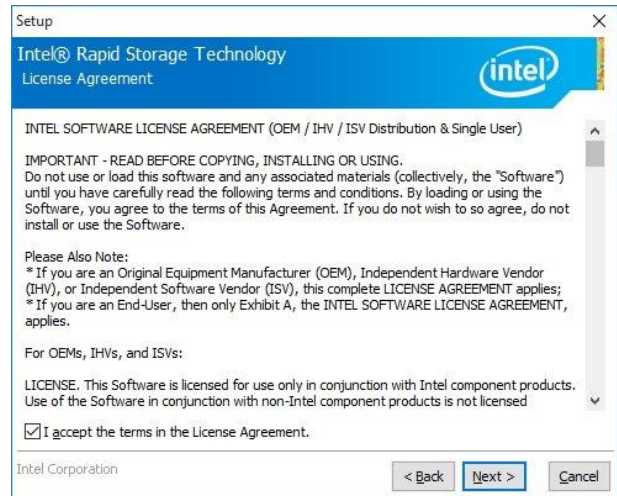

Step 3. Click Next.



Step 1. Click Next to continue installation.



Step 4. Click Next.



Step 2. Click Next.

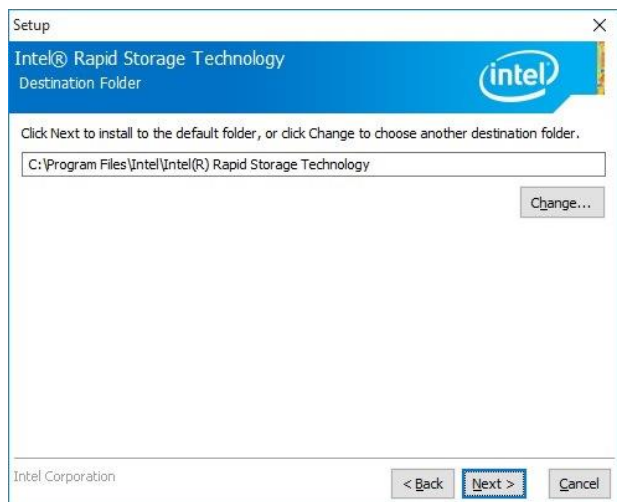

Step 5. Click Next.

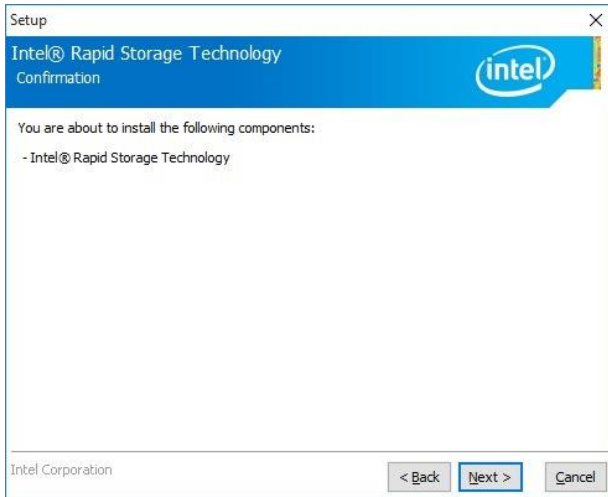

Step 6. Click **Next**.

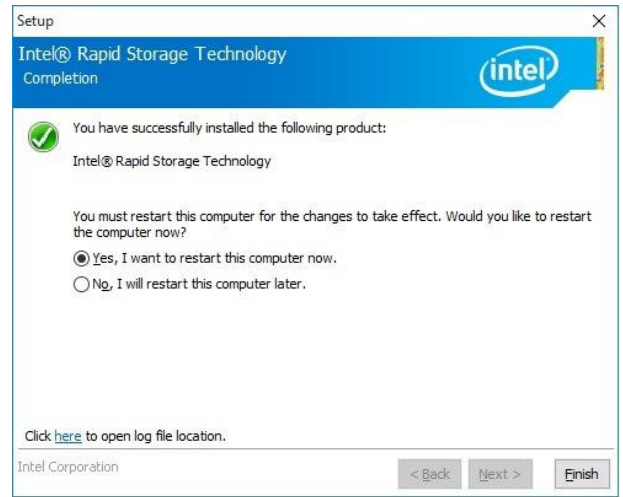

Step 7. Click **Finish** to complete the setup.

5. Mechanical Drawing
