

SPECIFICATIONS

CUSTOMER	:	PTC
SAMPLE CODE	:	SH240320T068-LAB08
MASS PRODUCTION CODE	:	PH240320T068-LAB08
SAMPLE VERSION	:	01
SPECIFICATIONS EDITION	:	003
DRAWING NO. (Ver.)	:	JLMD-PH240320T068-LAB08_001
PACKAGING NO. (Ver.)	:	JPKG-PH240320T068-LAB08_001

Customer Approved

Date:

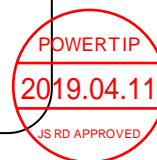

Approved	Checked	Designer
閔偉	劉進	陳璐

- Preliminary specification for design input
- Specification for sample approval

POWER TIP TECH. CORP.

Headquarters:

No.8, 6th Road, Taichung Industrial Park,
Taichung, Taiwan
台中市 407 工業區六路 8 號

TEL: 886-4-2355-8168
FAX: 886-4-2355-8166

E-mail: sales@powertip.com.tw
[Http://www.powertip.com.tw](http://www.powertip.com.tw)

Contents

1. SPECIFICATIONS

- 1.1 Features
- 1.2 Mechanical Specifications
- 1.3 Absolute Maximum Ratings
- 1.4 DC Electrical Characteristics
- 1.5 Optical Characteristics
- 1.6 Backlight Characteristics
- 1.7 Touch Panel Characteristics

2. MODULE STRUCTURE

- 2.1 Counter Drawing
- 2.2 Interface Pin Description
- 2.3 Timing Characteristics

3. QUALITY ASSURANCE SYSTEM

- 3.1 Quality Assurance Flow Chart
- 3.2 Inspection Specification

4. RELIABILITY TEST

- 4.1 Reliability Test Condition

5. PRECAUTION RELATING PRODUCT HANDLING

- 5.1 Safety
- 5.2 Handling
- 5.3 Storage
- 5.4 Terms of Warranty

Appendix : LCM Drawing
LCM Packaging

Note : For detailed information please refer to IC data sheet :

Primacy(TFT LCD): Sitronix : ST7789VI

1. SPECIFICATIONS

1.1 Features

Main LCD panel

Item	Standard Value
Display Type	240(R、G、B) * 320 Dots
LCD Type	Normally white , Transmissive type
Screen size(inch)	2.8 inch
Viewing Direction	12 O'clock
Color configuration	RGB-Strip
Interface	80-16bit parallel I/F II
Other(controller/driver IC)	Sitronix: ST7789VI
ROHS	THIS PRODUCT CONFORMS THE ROHS OF PTC Detail information please refer website : http://www.powertip.com.tw/news.php?area_id_view=1085560481/

1.2 Mechanical Specifications

Item	Standard Value	Unit
Outline Dimension	50.0(W) * 69.2 (L) * 4.25 (H)max	mm

LCD panel

Item	Standard Value	Unit
Active Area	43.2 (W) * 57.6 (L)	mm

1.3 Absolute Maximum Ratings

Module

Item	Symbol	Condition	Min.	Max.	Unit
System Power Supply Voltage	VCC	-	-0.3	+4.6	V
	VGH ~ VGL	-	-0.3	+30	V
Input Voltage	VIN	-	-0.3	VCC+0.5	V
Operating Temperature	T _{OP}	-	-20	+70	°C
Storage Temperature	T _{ST}	-	-30	+80	°C
Storage Humidity	H _D	T _a ≅ 40 °C	20	90	%RH

1.4 DC Electrical Characteristics

Module

GND = 0V, T_a = 25°C

Item	Symbol	Condition	Min.	Typ.	Max.	Unit
Power Supply Voltage1	VCC	-	2.4	2.8	3.6	V
Input High Voltage	V _{IH}	-	0.7 VCC	-	VCC	V
Input Low Voltage	V _{IL}	-	GND	-	0.3 VCC	V
Output High Voltage	V _{OH}	I _{OH} =-0.1mA	0.8*VCC	-	VCC	V
Output Low Voltage	V _{OL}	I _{OL} =0.1mA	GND	-	0.2*VCC	V
Supply Current	ICC	VCC = 2.8V	-	8	12	mA

Note1:Maximum current display

1.5 Optical Characteristics

TFT LCD Module

VCC = 2.8V, Ta=25°C

Item	Symbol	Condition	Min.	Typ.	Max.	unit	-	
Response time	Tr+ Tf	-	-	30	45	ms	Note2	
Viewing angle	Top	$\theta Y+$	-	60	-	Deg.	Note4	
	Bottom	$\theta Y-$	-	60	-			
	Left	$\theta X-$	-	60	-			
	Right	$\theta X+$	-	60	-			
Contrast ratio	CR	-	500	600	-	-	Note3	
Color of CIE Coordinate (With B/L)	White	X	IF=80 mA	0.25	0.30	0.35	-	Note1
		Y		0.26	0.31	0.36		
	Red	X		0.57	0.62	0.67		
		Y		0.31	0.36	0.41		
	Green	X		0.28	0.33	0.38		
		Y		0.55	0.60	0.65		
	Blue	X		0.10	0.15	0.20		
		Y		0.03	0.08	0.13		
Average Brightness Pattern=white display (With B/L) *1	IV	IF=80 mA	200	250	-	cd/m ²		
Uniformity (With B/L)*2	ΔB	IF=80 mA	70	-	-	%		

Note 1:

*1 : $\Delta B = B(\min) / B(\max) * 100\%$

*2 : Measurement Condition for Optical Characteristics:

a : Environment: $25^{\circ}\text{C} \pm 5^{\circ}\text{C}$ / $60 \pm 20\%$ R.H , no wind , dark room below 10 Lux at typical lamp current and typical operating frequency.

b : Measurement Distance: 500 ± 50 mm , ($\theta = 0^{\circ}$)

c : Equipment: TOPCON BM-7 fast , (field 1°) , after 10 minutes operation.

d : The uncertainty of the C.I.E coordinate measurement ± 0.01 , Average Brightness $\pm 4\%$

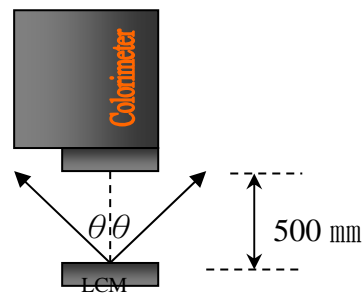
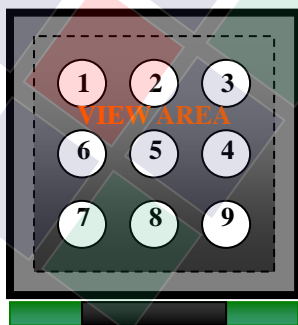

Colorimeter=BM-7 fast

To be measured at the center area of panel with a viewing cone of 1° by Topcon luminance meter BM-7, after 10 minutes operation (module)

Note2: Definition of response time:

The output signals of photo detector are measured when the input signals are changed from “black” to “white”(falling time) and from “white” to “black”(rising time), respectively. The response time is defined as the time interval between the 10% and 90% of Amplitudes.

Refer to figure as below:

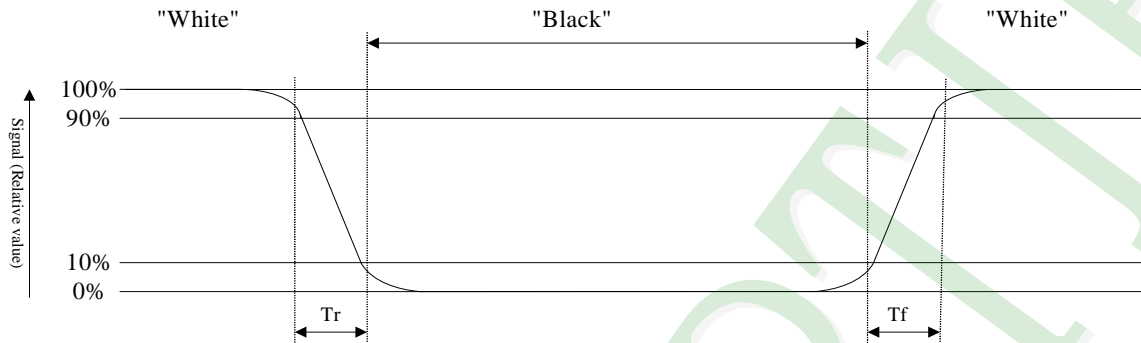

Note3: Definition of contrast ratio:

Contrast ratio is calculated with the following formula

$$\text{Contrast ratio (CR)} = \frac{\text{Photo detector output when LCD is at "White" state}}{\text{Photo detector output when LCD is at "Black" state}}$$

Note4: Definition of viewing angle:

Refer to figure as below:

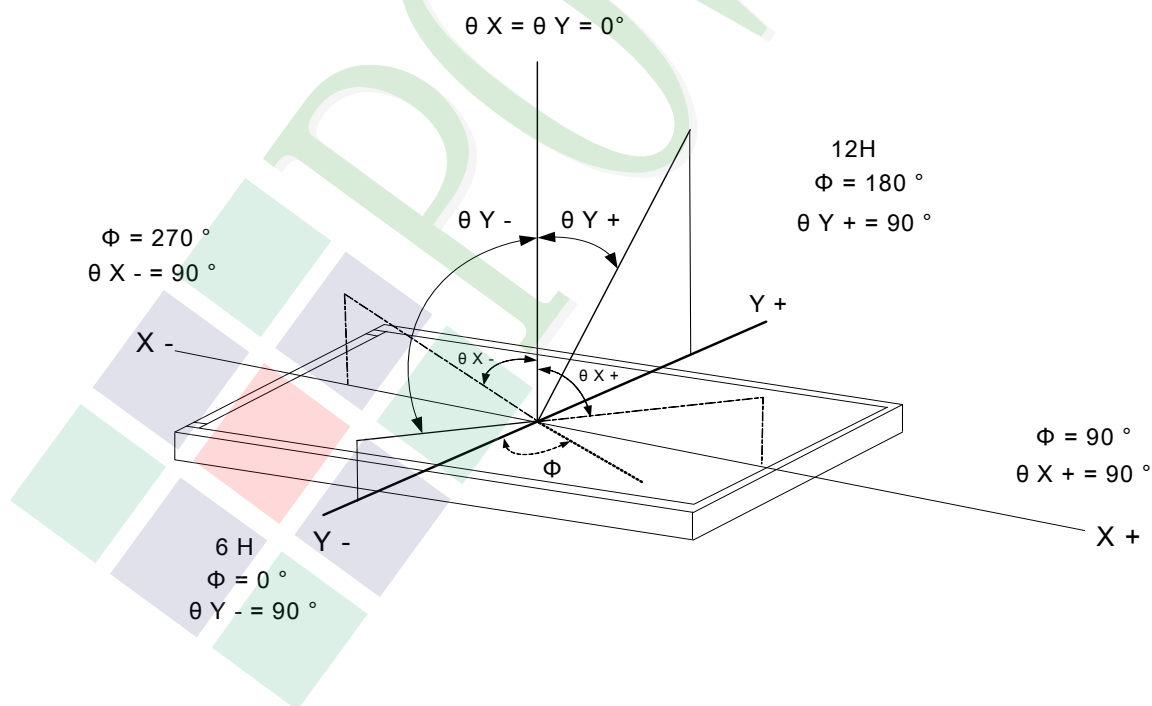

1.6 Backlight Characteristics

Maximum Ratings

Item	Symbol	Conditions	Min.	Max.	Unit
Forward Current	IF	Ta =25°C	-	30*4	mA
Reverse Voltage	VR	Ta =25°C	-	5	V
Power Dissipation	PD	Ta =25°C	-	90*4	mW

Electrical / Optical Characteristics

Item	Symbol	Conditions	Min.	Typ.	Max.	Unit
Forward Voltage	VF	IF= 80 mA	3.0	—	3.6	V
Average Brightness (without LCD)	IV		5000	5500	—	cd/m ²
CIE Color Coordinate (Without LCD)	X		0.26	0.28	0.33	-
	Y		0.26	0.28	0.33	
Color		White				

Internal Circuit

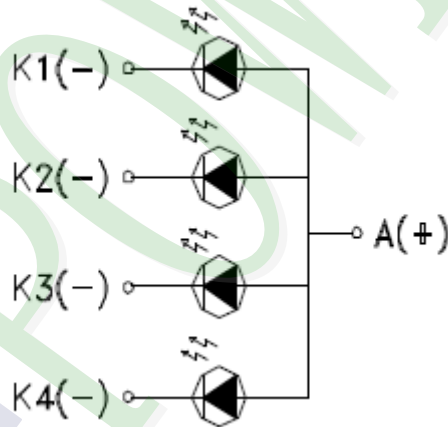

Other Description

Item	Conditions	Description
Life Time	Ta =25°C IF= 80 mA	20000 hrs

1.7 Touch Panel Characteristics

1.7.1 Optical Characteristics

Item	Specification
1. Transparency	80% Min

1.7.2 Mechanical Characteristic

Item	Specification
1. Input Method	Finger or stylus pen
2. Hardness of surface	3 H-pressure 500g of ,45deg.
3. FPC peeling strength	50gf min (Peeling upward by 90°)
4. Activation Force	50gf (Typical 20gf) less individual point with stylus pen (R0.8mm) Activation force guarantee area: 5.0mm inside of Active Area.
5. Linearity Force	80gf less input with stylus pen (R0.8mm) Linearity force guarantee area: 3.0mm inside of Active Area.

1.7.3 Electrical Characteristics

Item	Specification
1. Rated Voltage	DC 5V (DC 10V Max)
2. Resistance Between Terminals.	Direction X (Glass side): 100Ω~ 600Ω
	Direction Y (Film side): 250Ω~ 900Ω
3. Insulation Resistance	20 MΩ or more (DC 25V 1min)
4. Linearity	<p>≤1.5%.</p> <p>Linearity(%) = $\Delta V / (EV - SV) * 100$.</p> <p>$\Delta V$: The difference between the ideal voltage and measured voltage on the each measuring line.</p> <p>SV: Voltage of starting Points.</p> <p>EV: Voltage of Ending Points.</p>
5. Bouncing	<10ms (Tip R 3.75mm, hardness 10°~20° ,silicon rubber ,500gf operation : 40 mm/sec)

1.7.4 Reliability Characteristic

Item	Specification
1.Hitting Durability	1,000,000times min.(Tip R 8mm&R0.8mm)
2.Pen Sliding Durability	100,000 times min(Tip R0.8mm).
3.Impact Resistance	No damage when $\varphi 9$ mm steel ball is dropped on the surface from 30 cm height at 1 time.
4.Flexible pattern Bending Resistance	Bending 3 times by bending radius R1.0 mm
5.Flexible Pattern Insert/Pull Out Resistance	5times at least .

1.7.5 Touch Panel Design/Handing Guide

(1) Keep the gap, for example 0.2 to 0.3mm, between bezel edge and T/P edge.

The reason is to avoid the bezel edge from contacting T/P surface that may cause “short” with bottom layer

(2) Insertion a cushion material is recommended.

(3) The cushion material should be limited on the busbar insulation paste area. If it is over the transparent insulation paste area, a “short” may be occurred.

(4) Do not to use an adhesive tape to bond it on the front of T/P and hang it to the housing bezel.

(5) Never expand the T/P top layer (PET Film) like a balloon by internal air pressure. The life of the T/P will extremely decreasing.

(6) Top layer, PET, dimension is changing base on environment temperature and humidity. Please avoid a stress from housing bezel to top layer, because it may cause “waving”.

(7) The input to the Touch Panel sometimes distorts touch panel itself.

(8) To use the stylus pen or fingernail sliding at the edge of the housing is prohibited. It would cause the cracking of the ITO coating and damage the touch panel. It also request not to press this area while assembling

(9) Purpose: In order to prevent accidental use and performance deterioration, please keep the following precautions.

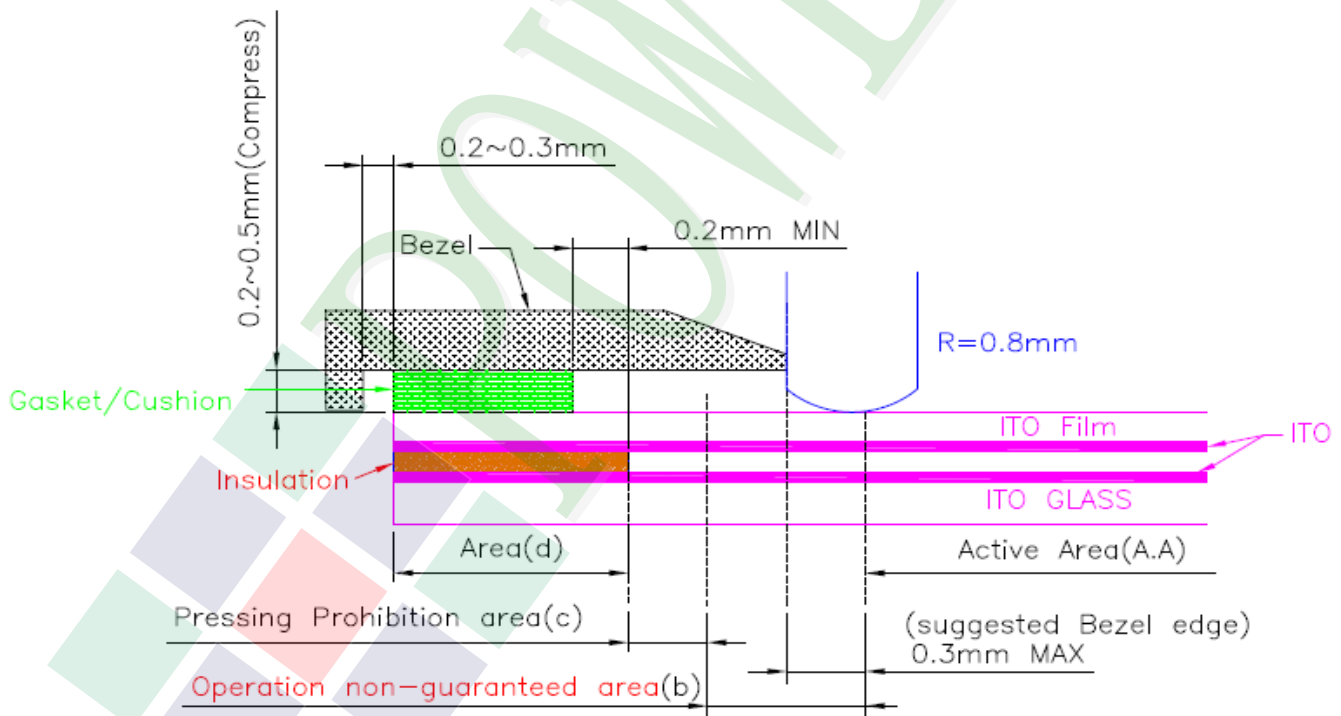

In order to prevent unusual performance degradation and malfunction of a touch panel, please carry out the set case designing and a touch panel assembling method after surely considering the definition of each area illustrated in above figure.

Area(a) : Active area

The active area is guaranteed the position data detectable precision, operation force and other operations. it is strongly recommended to place the operation button or menu keys within the active area. Due to structure, the active area is less durable at the edge or close to the edge.

Area(b) : Operation non-guaranteed area

This area does not guarantee a touch panel operation and its function. When this area is pressed, touch panel shows degradation of its performance and durability such as a pen sliding durability becomes about one-tenth compared with the active area (area-(a) as guaranteed area) and its operation force requires about double. About 0.5 mm outside from a boundary of the active area corresponds to this area.

Area(c) : Pressing prohibition area

The area which forbids pressing, because an excessive load is applied to a transparent electrode (ITO) and a serious damage is given to a touch panel function by pressing. About 0.5 mm outside from Operation non-guaranteed area .

Area(d) : Non-Active area

The area does not activate even if pressed.



2.1 Counter Drawing

2.1.1 LCM Mechanical Diagram

* See Appendix

2.1.2 Block Diagram

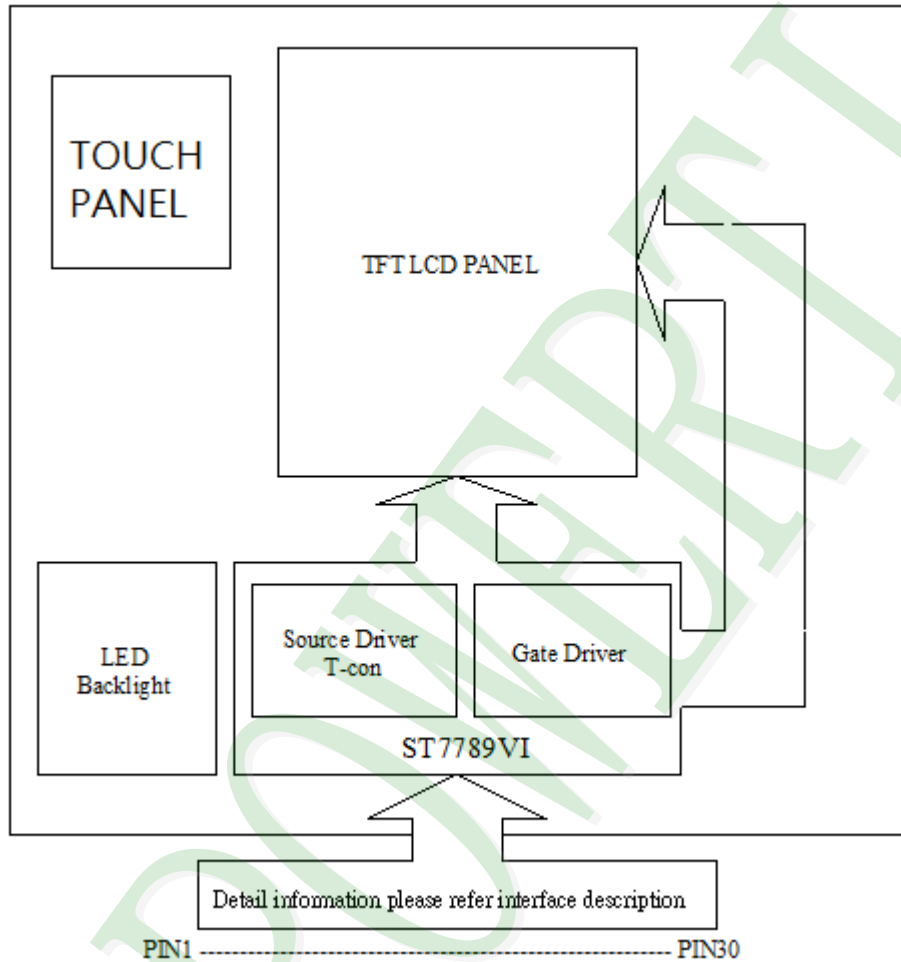

2.2 Interface Pin Description

Pin No.	Symbol	Function
1	LEDK1-4	Power supply for LED Backlight Cathode input
2	LEDA	Power supply for LED Backlight Anode input
3	GND	Signal ground.(0V)
4	RESET	Reset input pin for TFT LCD. When RESET is "L", initialization is executed.
5	DB17	Bi-directional data bus
6	DB16	
7	DB15	
8	DB14	
9	DB13	
10	DB12	
11	DB11	
12	DB10	
13	DB8	
14	DB7	
15	DB6	
16	DB5	
17	DB4	
18	DB3	
19	DB2	
20	DB1	
21	RD	Read signal input , active at Low.
22	WR/SCL	Write signal input , active at Low.
23	RS	When RS = 0: Command. When RS = 1: Display data.
24	CS	Chip select signal , Active at "L"
25	XR	Right side of touch panel.

Pin No.	Symbol	Function
26	YD	Bottom side of touch panel.
27	XL	Left side of touch panel.
28	YU	Up side of touch panel.
29	GND	Signal ground.(0V)
30	2.8 VCC	Power supply for the internal logic circuit.

2.2.1 Reference Initial code

```
void LCD_Init(void)
{
    LCD_WR_REG(0x01);

    delay_ms(100);

    LCD_WR_REG(0x11);

    delay_ms(120);

    LCD_WR_REG(0x36);
    LCD_WR_DATA(0x00);

    LCD_WR_REG(0x3a);
    LCD_WR_DATA(0x55);

    LCD_WR_REG(0xb2);
    LCD_WR_DATA(0x0C);
    LCD_WR_DATA(0x0C);
    LCD_WR_DATA(0x00);
    LCD_WR_DATA(0x33);
    LCD_WR_DATA(0x33);

    LCD_WR_REG(0xb7);
    LCD_WR_DATA(0x35);

    LCD_WR_REG(0xbb);
    LCD_WR_DATA(0x19);

    LCD_WR_REG(0xc0);
    LCD_WR_DATA(0x2c);

    LCD_WR_REG(0xc2);
    LCD_WR_DATA(0x01);

    LCD_WR_REG(0xc3);
    LCD_WR_DATA(0x12);
```



```
LCD_WR_REG(0xc4);  
LCD_WR_DATA(0x20);
```

```
LCD_WR_REG(0xc6);  
LCD_WR_DATA(0x0f);
```

```
LCD_WR_REG(0xd0);  
LCD_WR_DATA(0xa4);  
LCD_WR_DATA(0xa1);
```

```
/*-----Gamma Set-----*/
```

```
LCD_WR_REG(0xe0);  
LCD_WR_DATA(0xd0);  
LCD_WR_DATA(0x04);  
LCD_WR_DATA(0x0d);  
LCD_WR_DATA(0x11);  
LCD_WR_DATA(0x13);  
LCD_WR_DATA(0x2b);  
LCD_WR_DATA(0x3f);  
LCD_WR_DATA(0x54);  
LCD_WR_DATA(0x4c);  
LCD_WR_DATA(0x18);  
LCD_WR_DATA(0x0d);  
LCD_WR_DATA(0x0b);  
LCD_WR_DATA(0x1f);  
LCD_WR_DATA(0x23);
```

```
LCD_WR_REG(0xe1);  
LCD_WR_DATA(0xd0);  
LCD_WR_DATA(0x04);  
LCD_WR_DATA(0x0c);  
LCD_WR_DATA(0x11);  
LCD_WR_DATA(0x13);  
LCD_WR_DATA(0x2c);  
LCD_WR_DATA(0x3f);  
LCD_WR_DATA(0x44);  
LCD_WR_DATA(0x51);  
LCD_WR_DATA(0x2f);  
LCD_WR_DATA(0x1f);
```

```
LCD_WR_DATA(0x1f);  
LCD_WR_DATA(0x20);  
LCD_WR_DATA(0x23);  
/*-----Gamma Set End-----*/  
  
LCD_WR_REG(0x29); //Display on  
}
```



2.3 Timing Characteristics

8080 Series MCU Parallel Interface Characteristics: 18/16/9/8-bit Bus

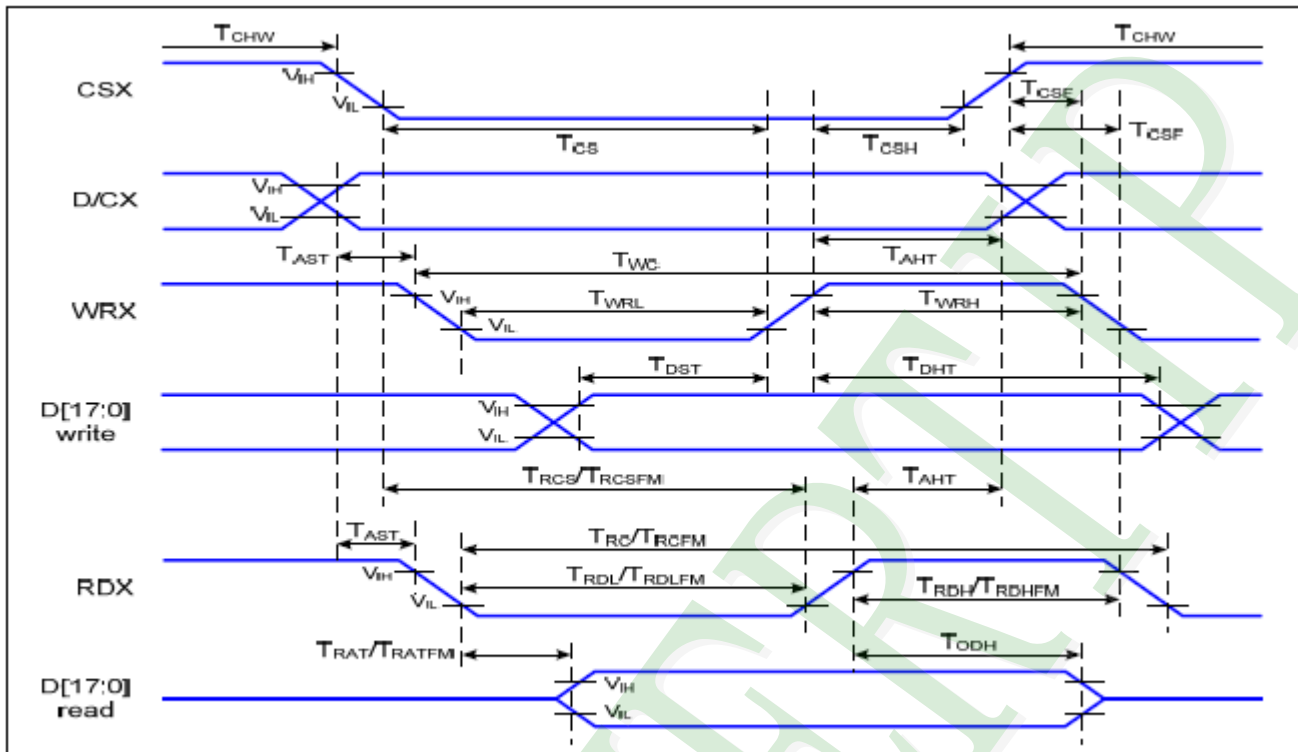
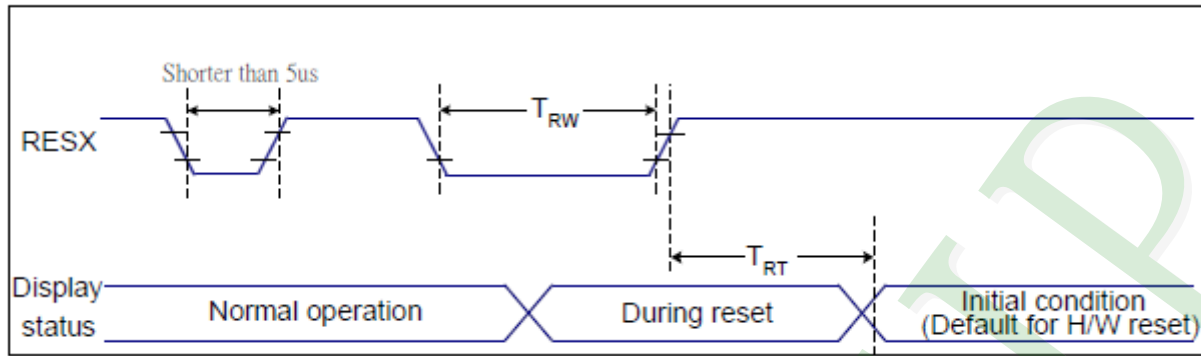

Figure 1 Parallel Interface Timing Characteristics (8080-Series MCU Interface)

Signal	Symbol	Parameter	Min	Max	Unit	Description
D/CX	T _{AST}	Address setup time	0		ns	
	T _{AHT}	Address hold time (Write/Read)	10		ns	
CSX	T _{CHW}	Chip select "H" pulse width	0		ns	
	T _{CS}	Chip select setup time (Write)	15		ns	
	T _{RCS}	Chip select setup time (Read ID)	45		ns	
	T _{RCSFM}	Chip select setup time (Read FM)	355		ns	
	T _{CSF}	Chip select wait time (Write/Read)	10		ns	
	T _{CSH}	Chip select hold time	10		ns	
WRX	T _{WC}	Write cycle	66		ns	
	T _{WRH}	Control pulse "H" duration	15		ns	
	T _{WRL}	Control pulse "L" duration	15		ns	
RDX (ID)	T _{RC}	Read cycle (ID)	160		ns	When read ID data
	T _{RDH}	Control pulse "H" duration (ID)	90		ns	
	T _{RDL}	Control pulse "L" duration (ID)	45		ns	
RDX (FM)	T _{RCFM}	Read cycle (FM)	450		ns	When read from frame memory
	T _{RDHFM}	Control pulse "H" duration (FM)	90		ns	
	T _{RDLFM}	Control pulse "L" duration (FM)	355		ns	
D[17:0]	T _{DST}	Data setup time	10		ns	For CL=30pF
	T _{DHT}	Data hold time	10		ns	
	T _{RAT}	Read access time (ID)		40	ns	
	T _{RATFM}	Read access time (FM)		340	ns	
	T _{ODH}	Output disable time	20	80	ns	

8080 Parallel Interface Characteristics

Reset Timing:



Reset Timing

VDDI=1.65 to 3.6V, VDD=2.4 to 3.6V, AGND=DGND=0V, Ta=25 °C

Related Pins	Symbol	Parameter	MIN	MAX	Unit
RESX	TRW	Reset pulse duration	10	-	us
	TRT	Reset cancel	-	5 (Note 1, 5)	ms
				120 (Note 1, 6, 7)	ms

Reset Timing

Notes:

1. The reset cancel includes also required time for loading ID bytes, VCOM setting and other settings from NVM (or similar device) to registers. This loading is done every time when there is HW reset cancel time (tRT) within 5 ms after a rising edge of RESX.
2. Spike due to an electrostatic discharge on RESX line does not cause irregular system reset according to the table below:

RESX Pulse	Action
Shorter than 5us	Reset Rejected
Longer than 9us	Reset
Between 5us and 9us	Reset starts

3. During the Resetting period, the display will be blanked (The display is entering blanking sequence, which maximum time is 120 ms, when Reset Starts in Sleep Out –mode. The display remains the blank state in Sleep In –mode.) and then return to Default condition for Hardware Reset.

4. Spike Rejection also applies during a valid reset pulse as shown below:

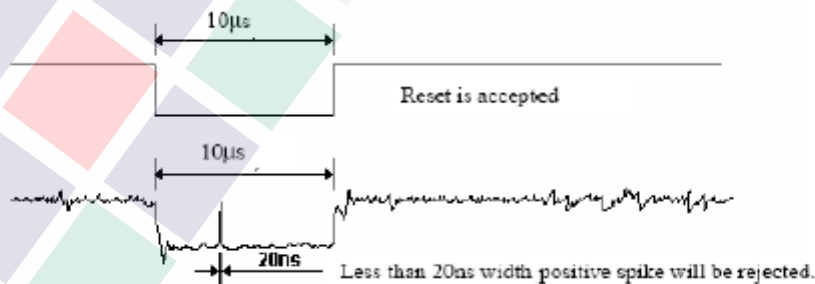

5. When Reset applied during Sleep In Mode.
6. When Reset applied during Sleep Out Mode.
7. It is necessary to wait 5msec after releasing RESX before sending commands. Also Sleep Out command cannot be sent for 120msec.

3. QUALITY ASSURANCE SYSTEM

3.1 Quality Assurance Flow Chart

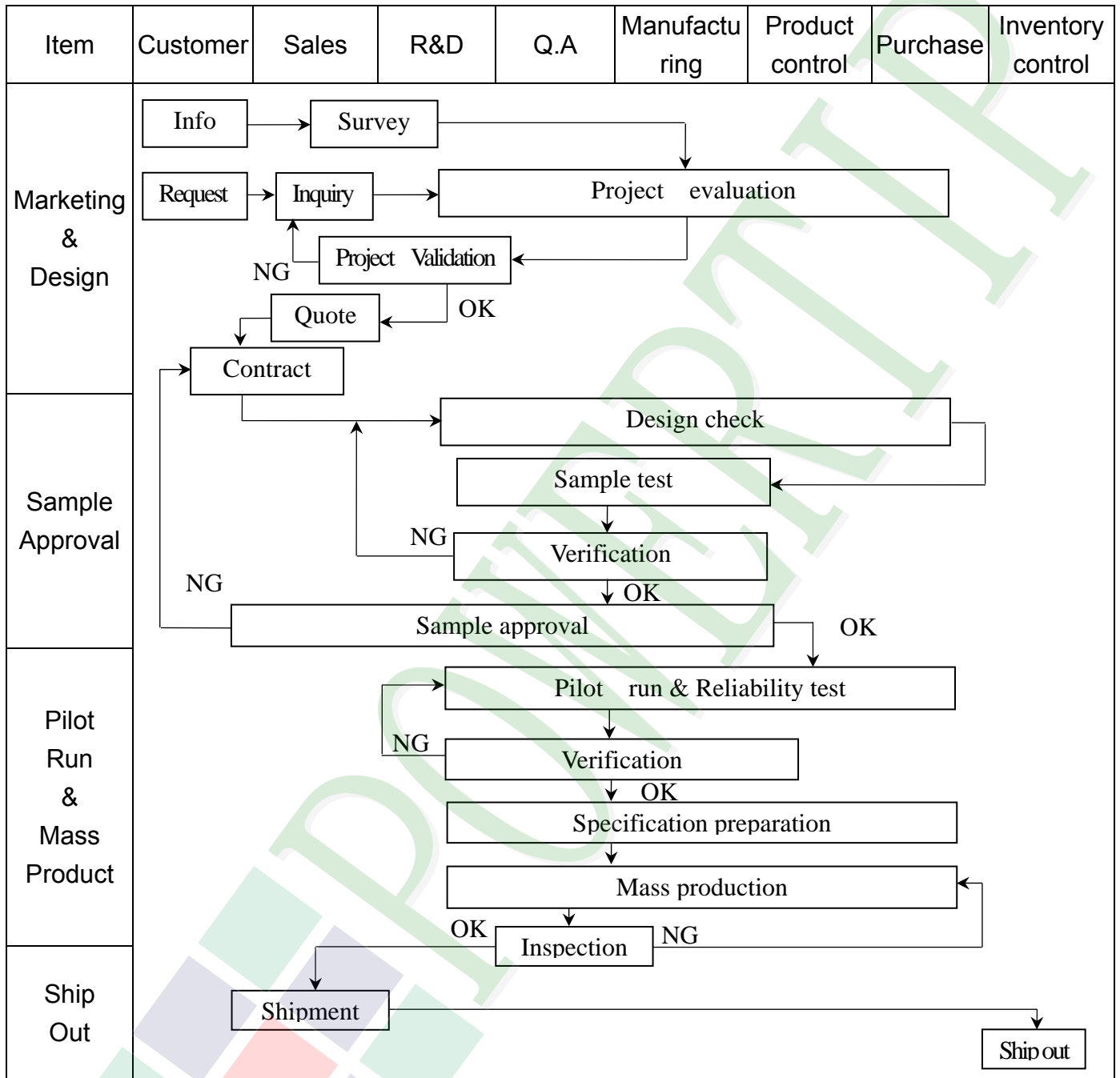

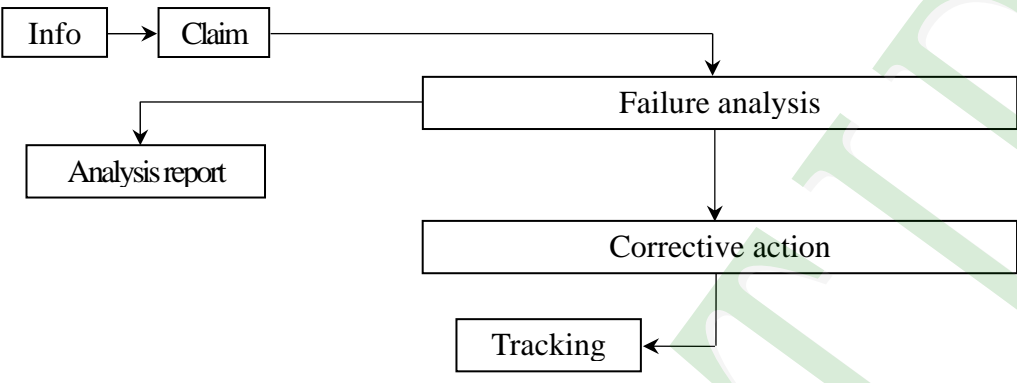
Item	Customer	Sales	R&D	Q.A	Manufacturing	Product control	Purchase	Inventory control
Sales Service	 <pre> graph TD Info[Info] --> Claim[Claim] Claim --> FA[Failure analysis] Claim --> AR[Analysis report] FA --> CA[Corrective action] CA --> Tracking[Tracking] </pre>							
Q.A Activity	1. ISO 9001 Maintenance Activities 3. Equipment calibration 5. Standardization Management				2. Process improvement proposal 4. Education And Training Activities			

3.2 Inspection Specification

- ◆ Scope : The document shall be applied to TFT-LCD Module for less than 3.5" (Ver.B01).
- ◆ Inspection Standard : MIL-STD-105E Table Normal Inspection Single Sampling Level II .
- ◆ Equipment : Gauge 、 MIL-STD 、 Powertip Tester 、 Sample
- ◆ Defect Level : Major Defect AQL : 0.4 ; Minor Defect AQL : 1.5
- ◆ OUT Going Defect Level : Sampling.
- ◆ Standard of the product appearance test :

a. Manner of appearance test :

- (1). The test best be under 20W×2 fluorescent light , and distance of view must be at 30 cm.
- (2). The test direction is base on about around 45° of vertical line.

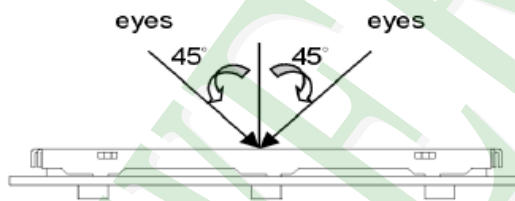

(3). Definition of area.

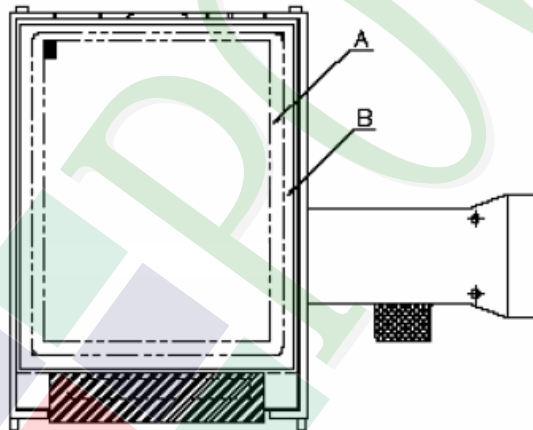

A area : viewing area

B area : Outside of viewing area

(4). Standard of inspection : (Unit : mm)

◆ Specification For TFT-LCD Module Less Than 3.5" :

(Ver.B01)

NO	Item	Criterion	Level										
01	Product condition	1. 1 The part number is inconsistent with work order of production.	Major										
		1. 2 Mixed product types.	Major										
		1. 3 Assembled in inverse direction.	Major										
02	Quantity	2. 1 The quantity is inconsistent with work order of production.	Major										
03	Outline dimension	3. 1 Product dimension and structure must conform to structure diagram.	Major										
04	Electrical Testing	4. 1 Missing line character and icon.	Major										
		4. 2 No function or no display.	Major										
		4. 3 Display malfunction.	Major										
		4. 4 LCD viewing angle defect.	Major										
		4. 5 Current consumption exceeds product specifications.	Major										
05	Dot defect (Bright dot , Dark dot) On -display	<table border="1" style="margin-left: auto; margin-right: auto;"> <thead> <tr> <th>Item</th> <th>Acceptance (Q'ty)</th> </tr> </thead> <tbody> <tr> <td>Bright Dot</td> <td>≤ 2</td> </tr> <tr> <td>Dark Dot</td> <td>≤ 3</td> </tr> <tr> <td>Joint Dot</td> <td>≤ 2</td> </tr> <tr> <td>Total</td> <td>≤ 3</td> </tr> </tbody> </table>	Item	Acceptance (Q'ty)	Bright Dot	≤ 2	Dark Dot	≤ 3	Joint Dot	≤ 2	Total	≤ 3	Minor
		Item	Acceptance (Q'ty)										
		Bright Dot	≤ 2										
		Dark Dot	≤ 3										
		Joint Dot	≤ 2										
Total	≤ 3												
5. 1 Inspection pattern : full white , full black , Red , Green and blue screens.													
5. 2 It is defined as dot defect if defect area $> 1/2$ dot.													
5. 3 The distance between two dot defect ≥ 5 mm.													

◆ Specification For TFT-LCD Module Less Than 3.5" :

(Ver.B01)

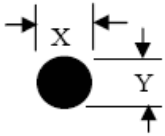
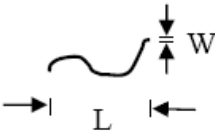
NO	Item	Criterion	Level																																								
06	<p>Black or white dot、scratch、contamination</p> <p>Round type</p>  <p>$\Phi = (x + y) / 2$</p> <p>Line type</p> 	<p>6. 1 Round type (Non-display or display) :</p> <table border="1" data-bbox="552 416 1321 869"> <thead> <tr> <th rowspan="2">Dimension (diameter : Φ)</th> <th colspan="2">Acceptance (Q'ty)</th> </tr> <tr> <th>A area</th> <th>B area</th> </tr> </thead> <tbody> <tr> <td>$\Phi \leq 0.15$</td> <td colspan="2">Ignore</td> </tr> <tr> <td>$0.15 < \Phi \leq 0.20$</td> <td>2</td> <td rowspan="3">Ignore</td> </tr> <tr> <td>$0.20 < \Phi \leq 0.30$</td> <td>2</td> </tr> <tr> <td>$\Phi > 0.30$</td> <td>0</td> </tr> <tr> <td>Total</td> <td colspan="2">3</td> </tr> </tbody> </table> <p>6. 2 Line type(Non-display or display) :</p> <table border="1" data-bbox="533 983 1340 1397"> <thead> <tr> <th colspan="2">Dimension</th> <th colspan="2">Acceptance (Q'ty)</th> </tr> <tr> <th>Length (L)</th> <th>Width (W)</th> <th>A area</th> <th>B area</th> </tr> </thead> <tbody> <tr> <td>---</td> <td>$W \leq 0.03$</td> <td>Ignore</td> <td rowspan="3">Ignore</td> </tr> <tr> <td>$L \leq 5.0$</td> <td>$0.03 < W \leq 0.05$</td> <td>3</td> </tr> <tr> <td>---</td> <td>$W > 0.05$</td> <td>As round type</td> </tr> <tr> <td colspan="2">Total</td> <td colspan="2">3</td> </tr> </tbody> </table>	Dimension (diameter : Φ)	Acceptance (Q'ty)		A area	B area	$\Phi \leq 0.15$	Ignore		$0.15 < \Phi \leq 0.20$	2	Ignore	$0.20 < \Phi \leq 0.30$	2	$\Phi > 0.30$	0	Total	3		Dimension		Acceptance (Q'ty)		Length (L)	Width (W)	A area	B area	---	$W \leq 0.03$	Ignore	Ignore	$L \leq 5.0$	$0.03 < W \leq 0.05$	3	---	$W > 0.05$	As round type	Total		3		Minor
Dimension (diameter : Φ)	Acceptance (Q'ty)																																										
	A area	B area																																									
$\Phi \leq 0.15$	Ignore																																										
$0.15 < \Phi \leq 0.20$	2	Ignore																																									
$0.20 < \Phi \leq 0.30$	2																																										
$\Phi > 0.30$	0																																										
Total	3																																										
Dimension		Acceptance (Q'ty)																																									
Length (L)	Width (W)	A area	B area																																								
---	$W \leq 0.03$	Ignore	Ignore																																								
$L \leq 5.0$	$0.03 < W \leq 0.05$	3																																									
---	$W > 0.05$	As round type																																									
Total		3																																									
07	<p>Polarizer Bubble</p>	<table border="1" data-bbox="542 1447 1332 1854"> <thead> <tr> <th rowspan="2">Dimension (diameter : Φ)</th> <th colspan="2">Acceptance (Q'ty)</th> </tr> <tr> <th>A area</th> <th>B area</th> </tr> </thead> <tbody> <tr> <td>$\Phi \leq 0.20$</td> <td colspan="2">Ignore</td> </tr> <tr> <td>$0.20 < \Phi \leq 0.50$</td> <td>3</td> <td rowspan="2">Ignore</td> </tr> <tr> <td>$\Phi > 0.50$</td> <td>0</td> </tr> <tr> <td>Total</td> <td colspan="2">3</td> </tr> </tbody> </table>	Dimension (diameter : Φ)	Acceptance (Q'ty)		A area	B area	$\Phi \leq 0.20$	Ignore		$0.20 < \Phi \leq 0.50$	3	Ignore	$\Phi > 0.50$	0	Total	3		Minor																								
Dimension (diameter : Φ)	Acceptance (Q'ty)																																										
	A area	B area																																									
$\Phi \leq 0.20$	Ignore																																										
$0.20 < \Phi \leq 0.50$	3	Ignore																																									
$\Phi > 0.50$	0																																										
Total	3																																										

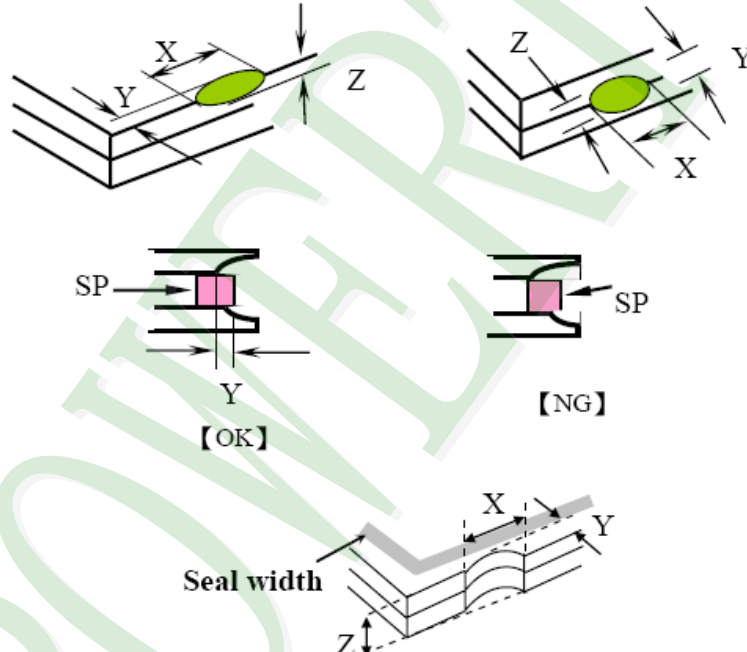
NO	Item	Criterion	Level									
08	The crack of glass	<p>Symbols :</p> <p>X : The length of crack Z : The thickness of crack t : The thickness of glass</p> <p>Y : The width of crack. W : terminal length a : LCD side length</p> <hr/> <p>8.1 General glass chip :</p> <p>8.1.1 Chip on panel surface and crack between panels:</p>  <table border="1" data-bbox="550 1433 1348 1724"> <thead> <tr> <th>X</th> <th>Y</th> <th>Z</th> </tr> </thead> <tbody> <tr> <td>$\leq a$</td> <td>Crack can't enter viewing area</td> <td>$\leq 1/2 t$</td> </tr> <tr> <td>$\leq a$</td> <td>Crack can't exceed the half of SP width.</td> <td>$1/2 t < Z \leq 2 t$</td> </tr> </tbody> </table>	X	Y	Z	$\leq a$	Crack can't enter viewing area	$\leq 1/2 t$	$\leq a$	Crack can't exceed the half of SP width.	$1/2 t < Z \leq 2 t$	Minor
		X	Y	Z								
$\leq a$	Crack can't enter viewing area	$\leq 1/2 t$										
$\leq a$	Crack can't exceed the half of SP width.	$1/2 t < Z \leq 2 t$										

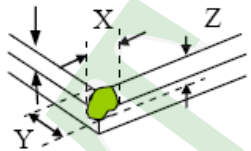
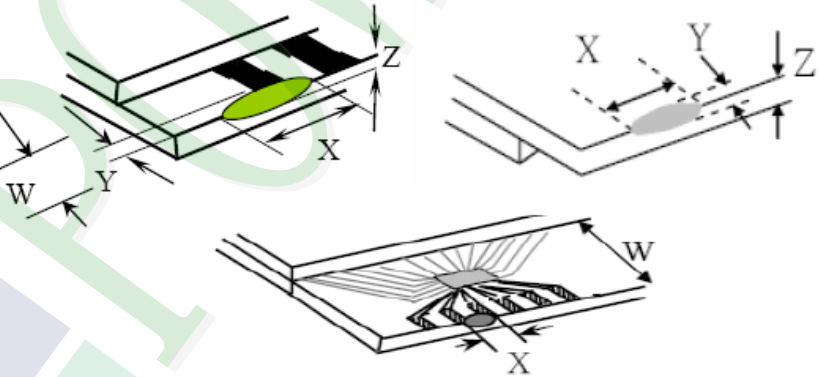
NO	Item	Criterion	Level										
08	The crack of glass	<p>Symbols :</p> <p>X : The length of crack Z : The thickness of crack t : The thickness of glass</p> <p>Y : The width of crack. W : terminal length a : LCD side length</p> <hr/> <p>8.1.2 Corner crack :</p>  <table border="1" data-bbox="533 768 1337 1055"> <thead> <tr> <th>X</th> <th>Y</th> <th>Z</th> </tr> </thead> <tbody> <tr> <td>$\leq 1/5 a$</td> <td>Crack can't enter viewing area</td> <td>$Z \leq 1/2 t$</td> </tr> <tr> <td>$\leq 1/5 a$</td> <td>Crack can't exceed the half of SP width.</td> <td>$1/2 t < Z \leq 2 t$</td> </tr> </tbody> </table>	X	Y	Z	$\leq 1/5 a$	Crack can't enter viewing area	$Z \leq 1/2 t$	$\leq 1/5 a$	Crack can't exceed the half of SP width.	$1/2 t < Z \leq 2 t$	Minor	
		X	Y	Z									
$\leq 1/5 a$	Crack can't enter viewing area	$Z \leq 1/2 t$											
$\leq 1/5 a$	Crack can't exceed the half of SP width.	$1/2 t < Z \leq 2 t$											
<p>8.2 Protrusion over terminal :</p> <p>8.2.1 Chip on electrode pad :</p>  <table border="1" data-bbox="571 1653 1345 1823"> <thead> <tr> <th></th> <th>X</th> <th>Y</th> <th>Z</th> </tr> </thead> <tbody> <tr> <td>Front</td> <td>$\leq a$</td> <td>$\leq 1/2 W$</td> <td>$\leq t$</td> </tr> <tr> <td>Back</td> <td>$\leq a$</td> <td>$\leq W$</td> <td>$\leq 1/2 t$</td> </tr> </tbody> </table>		X	Y	Z	Front	$\leq a$	$\leq 1/2 W$	$\leq t$	Back	$\leq a$	$\leq W$	$\leq 1/2 t$	
	X	Y	Z										
Front	$\leq a$	$\leq 1/2 W$	$\leq t$										
Back	$\leq a$	$\leq W$	$\leq 1/2 t$										

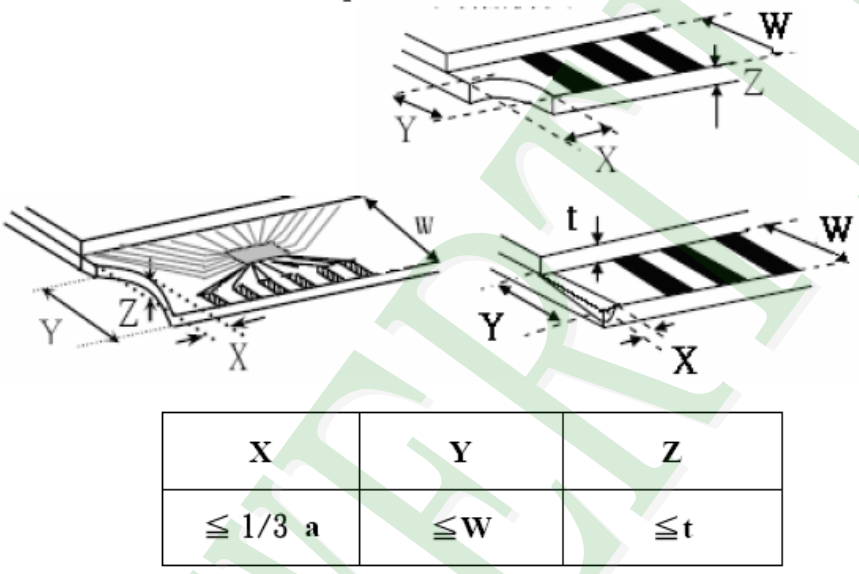
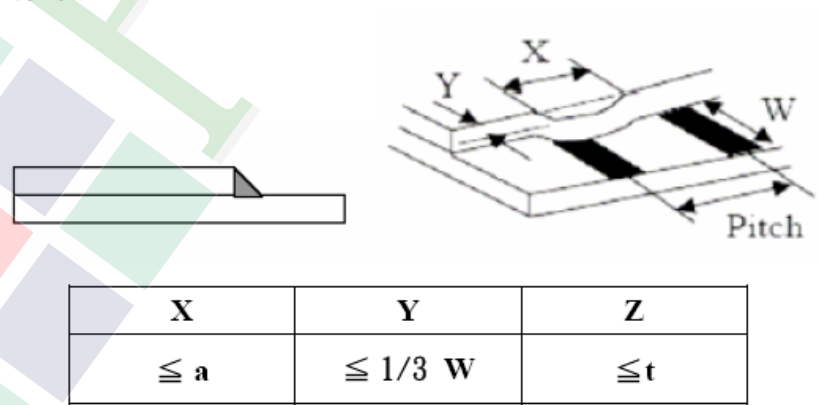
NO	Item	Criterion	Level
08	The crack of glass	<p>Symbols :</p> <p>X : The length of crack Y : The width of crack. Z : The thickness of crack W : terminal length t : The thickness of glass a : LCD side length</p>	Minor
		<p>8.2.2 Non-conductive portion :</p>  <p>⊙ If the chipped area touches the ITO terminal, over 2/3 of the ITO must remain and be inspected according to electrode terminal specifications.</p> <p>8.2.3 Glass remain :</p> 	

◆ Specification For TFT-LCD Module Less Than 3.5" :

(Ver.B01)

NO	Item	Criterion	Level
09	Backlight elements	9. 1 Backlight can't work normally.	Major
		9. 2 Backlight doesn't light or color is wrong.	Major
		9. 3 Illumination source flickers when lit.	Major
10	General appearance	10. 1 Pin type 、 quantity 、 dimension must match type in structure diagram.	Major
		10. 2 No short circuits in components on PCB or FPC .	Major
		10. 3 Parts on PCB or FPC must be the same as on the production characteristic chart .There should be no wrong parts , missing parts or excess parts.	Major
		10. 4 Product packaging must the same as specified on packaging specification sheet.	Minor
		10. 5 The folding and peeled off in polarizer are not acceptable.	Minor
		10. 6 The PCB or FPC between B/L assembled distance(PCB or FPC) is ≤ 1.5 mm.	Minor

5. PRECAUTION RELATING PRODUCT HANDLING

5.1 SAFETY

- 5.1.1 If the LCD panel breaks , be careful not to get the liquid crystal to touch your skin.
- 5.1.2 If the liquid crystal touches your skin or clothes , please wash it off immediately by using soap and water.

5.2 HANDLING

- 5.2.1 Avoid any strong mechanical shock which can break the glass.
- 5.2.2 Avoid static electricity which can damage the CMOS LSI—When working with the module , be sure to ground your body and any electrical equipment you may be using.
- 5.2.3 Do not remove the panel or frame from the module.
- 5.2.4 The polarizing plate of the display is very fragile. So , please handle it very carefully ,do not touch , push or rub the exposed polarizing with anything harder than an HB pencil lead (glass , tweezers , etc.)
- 5.2.5 Do not wipe the polarizing plate with a dry cloth , as it may easily scratch the surface of plate.
- 5.2.6 Do not touch the display area with bare hands , this will stain the display area.
- 5.2.7 Do not use ketonics solvent & aromatic solvent. Use with a soft cloth soaked with a cleaning naphtha solvent.
- 5.2.8 To control temperature and time of soldering is $320\pm 10^{\circ}\text{C}$ and 3-5 sec.
- 5.2.9 To avoid liquid (include organic solvent) stained on LCM .
- 5.2.10 Caution!(LCM products with Capacitive Touch Panel)
Strong EMI-sources such as switch-mode power supplies (SMPS) can lead to touch malfunction (e.g. ghost-touches).
Therefore, the touch needs to be thoroughly tested inside the target application.

5.3 STORAGE

- 5.3.1 Store the panel or module in a dark place where the temperature is $25^{\circ}\text{C} \pm 5^{\circ}\text{C}$ and the humidity is below 65% RH.
- 5.3.2 Do not place the module near organics solvents or corrosive gases.
- 5.3.3 Do not crush , shake , or jolt the module.

5.4 TERMS OF WARRANTY

- 5.4.1 Applicable warrant period
The period is within thirteen months since the date of shipping out under normal using and storage conditions.
- 5.4.2 Unaccepted responsibility
This product has been manufactured to your company's specification as a part for use in your company's general electronic products. It is guaranteed to perform according to delivery specifications. For any other use apart from general electronic equipment , we cannot take responsibility if the product is used in

nuclear power control equipment , aerospace equipment , fire and security systems or any other applications in which there is a direct risk to human life and where extremely high levels of reliability are required.



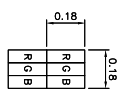
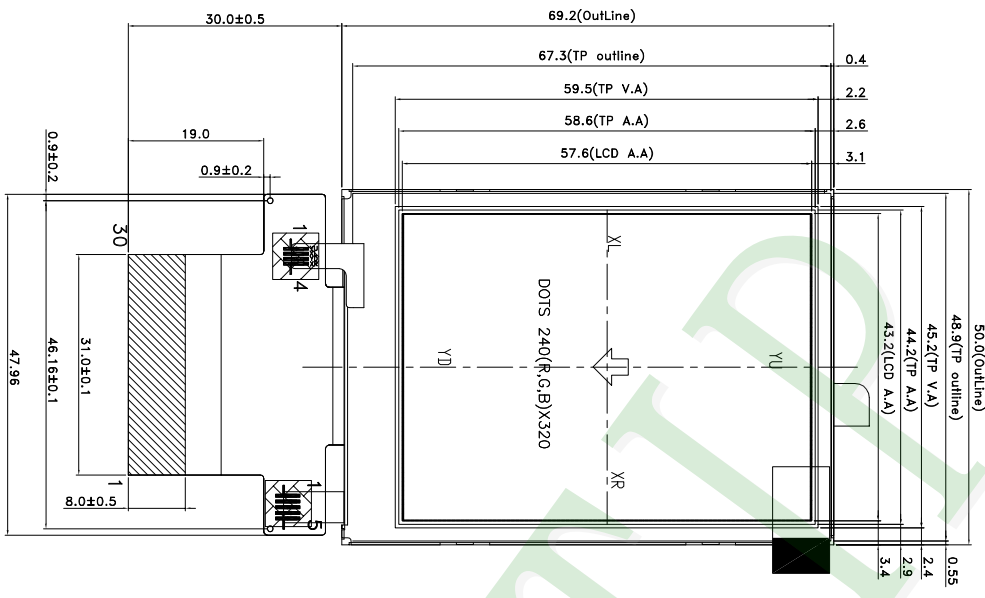

SCALE:30X

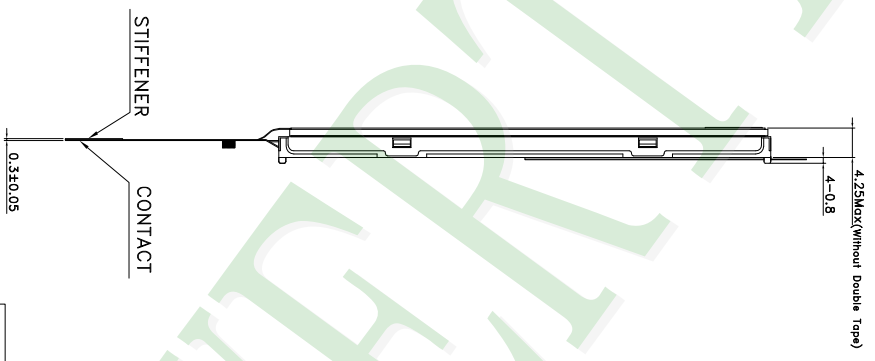

PIN OUT	1	2	3	4
	YU	XL	YD	XR

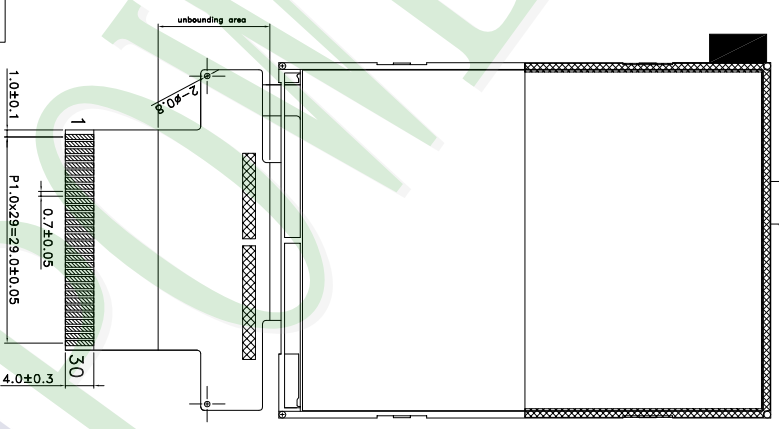

- NOTES:
- 1.) LCD TYPE: a-Si TFT
 - 2.) LCD DISPLAY: POSITIVE/TRANSMISSIVE
 - 3.) VIEWING DIRECTION: 12 O'CLOCK
 - 4.) THE TOLERANCE UNLESS CLASSIFIED ±0.3mm
 - 5.) THE R FOR NOT ASSIGNED 0.5 ± 0.1mm
 - 6.) THE COMPONENT AREA HEIGHT 1.0 MAX.
- 6.) JFPC suggested connector : KYOCERA(00-6200 307 032 800) or compatible.

007		PART NO:	PH240320T068-LAB08	Design	Crystal	久正光电股份有限公司 POWER TIP TECHNOLOGY CORPORATION	Surface	Thickness	Quantity	Precision Level
006		DRAWING NAME :	JLMD-PH240320T068-LAB08	Check	Terry					
005				Approve	Ryan	Unit	MM	1 ~ 4	4 ~ 16	-
004		TITLE:	LCD MODULE DRAWING			Scale	FIT	16 ~ 63	63 ~ 250	-
003						Page	1/1	250 ~ 1000	-	-
002										
001	NEW DRAWING	REVISER	Crystal	DATE	2019/01/18					
REV		REVISER	Crystal	DATE	2019/01/18					

1. 包裝材料規格表 (Packaging Material) : (per carton)

No.	Item	Model	Dimensions (mm)	1Pcs Weight	Quantity	Total Weight
1	成品 (LCM)	PH240320T068-LAB08	69.2 X 50 X 4.25	0.021	504	10.584
2	多層薄膜(1)POF	OTFILM0BA03ABA	19"X350X0.015	—	6	—
3	TRAY 盤 (2)Tray	TYSG000000030	352 X 260 X 12.3	0.1	48	4.8
4	內盒(3)Product Box	BX36627063ABBA	383 X 270 X 66	0.182	6	1.092
5	保利龍板(4)Pollyon board	OTPLB00PL08ABA	550 X 393 X 20	0.0284	2	0.0568
6	外紙箱(5)Carton	BX57041027CCBA	570 X 410 X 265	1.0	1	1.0
7						
8						
9						

2. 一整箱總重量 (Total LCD Weight in carton) : 17.48 Kg±10%

3. 單箱數量規格表 (Packaging Specifications and Quantity) :

(1) LCM quantity per box : no per tray	12	x no of tray	7	=	84
(2) Total LCM quantity in carton : quantity per box	84	x no of boxes	6	=	504

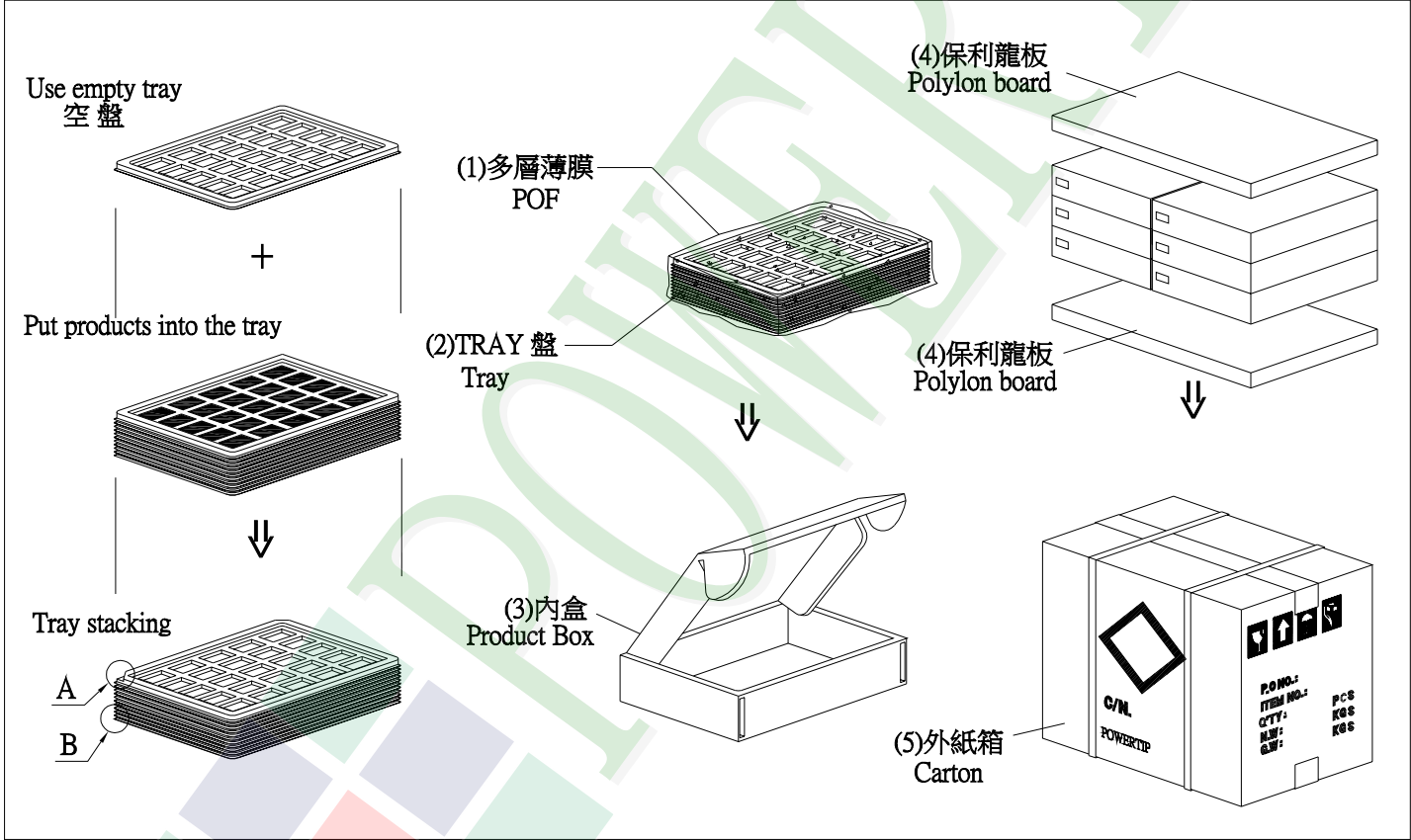

特 記 事 項 (REMARK)

