



## SPECIFICATIONS

<b>CUSTOMER</b>	:	_____
<b>SAMPLE CODE</b>	:	SH240320T073-ZAA
<b>MASS PRODUCTION CODE</b>	:	PH240320T073-ZAA
<b>SAMPLE VERSION</b>	:	01
<b>SPECIFICATIONS EDITION</b>	:	004
<b>DRAWING NO. (Ver.)</b>	:	LMD-PH240320T073-ZAA (Ver.002)
<b>PACKAGING NO. (Ver.)</b>	:	PKG-PH240320T073-ZAA (Ver.001)

**Customer Approved**

---

**Date:**

Approved	Checked	Designer
廖志豪 Rex Liao	廖志豪 Rex Liao	張慶源 Yuan Chang

- Preliminary specification for design input
- Specification for sample approval

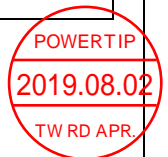

### POWERTIP TECH. CORP.

<b>Headquarters:</b> No.8, 6 <sup>th</sup> Road, Taichung Industrial Park, Taichung, Taiwan 台中市 407 工業區六路 8 號	TEL: 886-4-2355-8168 FAX: 886-4-2355-8166	E-mail: <a href="mailto:sales@powertip.com.tw">sales@powertip.com.tw</a> Http://www.powertip.com.tw
---	--	--

## History of Version

Date <small>(mm / dd / yyyy)</small>	Ver.	Edi.	Description	Page	Design by
07/30/2018	01	001	New Drawing	-	Yuan
10/02/2018	01	002	First Sample	-	Yuan
12/12/2018	01	003	Modify Contrast ratio	6	Yuan
08/02/2019	01	004	Modify LCD display from Normal white to Normally black	Appendix	Yuan

Total: 29 Page

## Contents

### 1. SPECIFICATIONS

- 1.1 Features
- 1.2 Mechanical Specifications
- 1.3 Absolute Maximum Ratings
- 1.4 DC Electrical Characteristics
- 1.5 Optical Characteristics
- 1.6 Backlight & LED Characteristics

### 2. MODULE STRUCTURE

- 2.1 Counter Drawing
- 2.2 Interface Pin Description
  - 2.2.1 Application Notes
  - 2.2.2 Refer Initial code
- 2.3 Timing Characteristics

### 3. QUALITY ASSURANCE SYSTEM

- 3.1 Quality Assurance Flow Chart
- 3.2 Inspection Specification

### 4. RELIABILITY TEST

- 4.1 Reliability Test Condition

### 5. PRECAUTION RELATING PRODUCT HANDLING

- 5.1 Safety
- 5.2 Handling
- 5.3 Storage
- 5.4 Terms of Warranty

#### Appendix :

- 1. LCM Drawing
- 2. LCM Packaging Specifications

Note : For detailed information please refer to IC data sheet :

Sitronix:ST7789VI (Or Compatible IC)

## 1. SPECIFICATIONS

### 1.1 Features

#### Main LCD Panel

Item	Standard Value
Display Type	240 * (R、G、B) * 320 Dots
LCD Type	IPS, Normally Black, Transmissive
Screen size(inch)	2.4 (Diagonal)
Color configuration	R.G.B. vertical stripe
Backlight	White LED
Interface	8 Bit Interface for i80system
Driver IC	Sitronix:ST7789VI (Or Compatible IC)
ROHS	THIS PRODUCT CONFORMS THE ROHS OF PTC Detail information please refer website : <a href="http://www.powertip.com.tw/news_detail.php?Key=1&amp;cID=1">http://www.powertip.com.tw/news_detail.php?Key=1&amp;cID=1</a>

### 1.2 Mechanical Specifications

Item	Standard Value	Unit
Outline Dimension	42.32 (W) * 60.06 (L) * 2.1 (H)	mm

#### LCD Panel

Item	Standard Value	Unit
Viewing Area	37.72 (W) * 49.96(L)	mm
Active Area	36.72(W) * 48.96(L)	mm

Note : For detailed information please refer to LCM drawing

### 1.3 Absolute Maximum Ratings

#### Module

Item	Symbol	Condition	Min.	Max.	Unit
System Power Supply Voltage	VDD	-	-0.3	4.6	V
	VGH-VGL	GND	0	+30	
Logic Input Voltage	V <sub>IN</sub>	-	-0.3	VDD+0.5	V
Operating Temperature	TOP	-	-20	70	°C
Storage Temperature	TST	-	-30	80	°C

### 1.4 DC Electrical Characteristics

#### Module

GND = 0V, Ta = 25°C

Item	Symbol	Condition	Min.	Typ.	Max.	Unit
Power Supply Voltage	VDD	-	-	2.8	-	V
Input High Voltage	V <sub>IH</sub>	-	0.7*VDD	-	VDD	V
Input Low Voltage	V <sub>IL</sub>	-	GND	-	0.3*VDD	V
Output High Voltage	V <sub>OH</sub>	I <sub>OH</sub> =-0.1mA	0.8*VDD	-	VDD	V
Output Low Voltage	V <sub>OL</sub>	I <sub>OL</sub> =0.1mA	GND	-	0.2*VDD	V
Supply Current	I <sub>DD</sub>	VDD = 2.8V Pattern= Full display *1	-	9	12	mA

Note 1: Maximum current display

## 1.5 Optical Characteristics

### TFT LCD panel

VDD= 2.8 V, Ta=25°C

Item		Symbol	Condition	Min.	Typ.	Max.	unit	
Response time	Rise	Tr+Tf	Ta = 25°C θX, θY = 0°	-	35	45	ms	Note2
	Fall							
Viewing angle	Top	θY+	CR ≥ 10	-	80	-	Deg.	Note4
	Bottom	θY-		-	80	-		
	Left	θX-		-	80	-		
	Right	θX+		-	80	-		
Contrast ratio		CR	Ta = 25°C θX, θY = 0°	650	800	-	-	Note3
Color of CIE Coordinate (With LCD)	White	X	Ta = 25°C θX, θY = 0°	0.26	0.31	0.36	-	Note1
		Y		0.28	0.33	0.38		
	Red	X		0.59	0.64	0.69		
		Y		0.29	0.34	0.39		
	Green	X		0.28	0.33	0.38		
		Y		0.56	0.61	0.66		
	Blue	X		0.09	0.14	0.19		
		Y		0.01	0.04	0.09		
Average Brightness Pattern=white display (With LCD )		IV	IF=60 mA	160	190	-	cd/m <sup>2</sup>	Note1
Uniformity (With LCD )		△B	IF=60 mA	80	-	-	%	Note1

Note1:

\*1 :  $\Delta B = B(\min) / B(\max) * 100\%$

\*2 : Measurement Condition for Optical Characteristics:

a : Environment:  $25^{\circ}\text{C} \pm 5^{\circ}\text{C}$  /  $60 \pm 20\%$  R.H , no wind , dark room below 10 Lux at typical lamp current and typical operating frequency.

b : Measurement Distance:  $500 \pm 50$  mm , ( $\theta = 0^{\circ}$ )

c : Equipment: TOPCON BM-7 fast , (field  $1^{\circ}$ ) , after 10 minutes operation.

d : The uncertainty of the C.I.E coordinate measurement  $\pm 0.01$  , Average Brightness  $\pm 4\%$

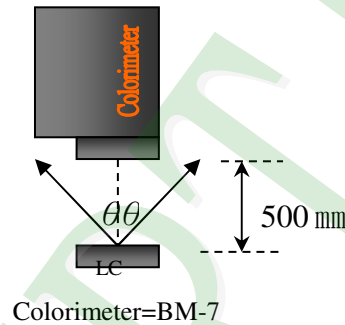
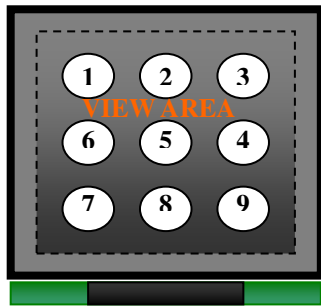

To be measured at the center area of panel with a viewing cone of  $1^{\circ}$  by Topcon luminance meter BM-7, after 10 minutes operation (module)

Note2: Definition of response time:

The output signals of photo detector are measured when the input signals are changed from "black" to "white"(falling time) and from "white" to "black"(rising time), respectively. The response time is defined as the time interval between the 10% and 90% of Amplitudes.

Refer to figure as below:

Normally White

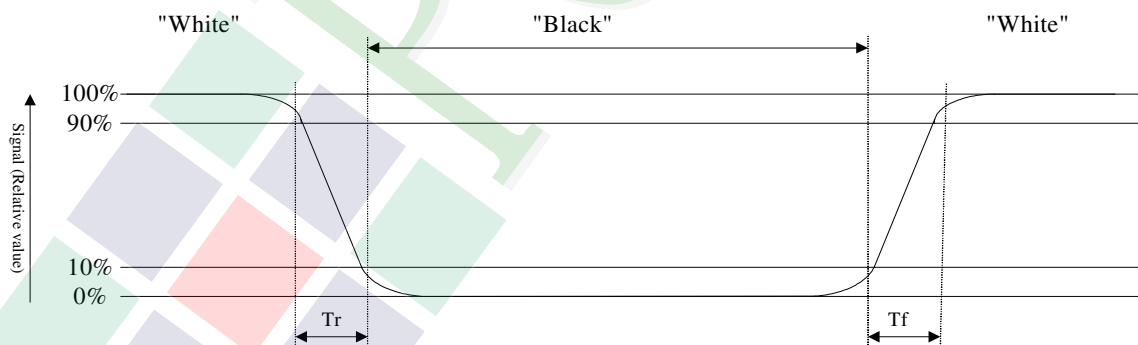

### Normally Black

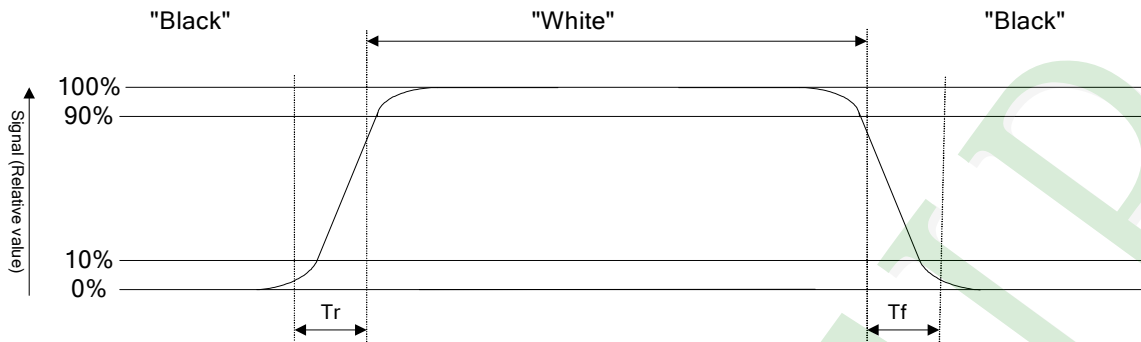

Note3: Definition of contrast ratio:

Contrast ratio is calculated with the following formula

$$\text{Contrast ratio (CR)} = \frac{\text{Photo detector output when LCD is at "White" state}}{\text{Photo detector output when LCD is at "Black" state}}$$

Note4: Definition of viewing angle:

Refer to figure as below:





## 1.6 Backlight & LED Characteristics

LCD Module with LED Backlight

### Maximum Ratings

Item	Symbol	Conditions	Min.	Max.	Unit
Forward Current	IF	Ta =25°C	-	75	mA
Reverse Voltage	VR	Ta =25°C	-	4	V

### Electrical / Optical Characteristics

Item	Symbol	Conditions	Min.	Typ.	Max.	Unit
Forward Voltage	VF	IF= 60 mA	-	3.2	3.5	V
Average Brightness (without LCD )	IV		3200	3830	-	cd/m <sup>2</sup>
Color of CIE Coordinate*1 (Without LCD )	X		0.24	0.27	0.30	*2
	Y		0.24	0.27	0.30	
Color	White					

\*1 : This value will be changed while mass production.

\*2 :  $\Delta B = B(\min) / B(\max) * 100\%$

B/L Internal Circuit Diagram

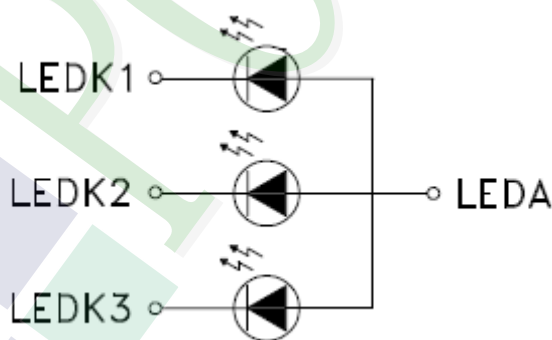

Item	Conditions	Description
MTBF (Life Time)	Ta =25°C IF= 60 mA	20000 hrs

## 2. MODULE STRUCTURE

### 2.1 Counter Drawing

#### 2.1.1 LCM Mechanical Diagram

\* See Appendix

#### 2.1.2 Block Diagram

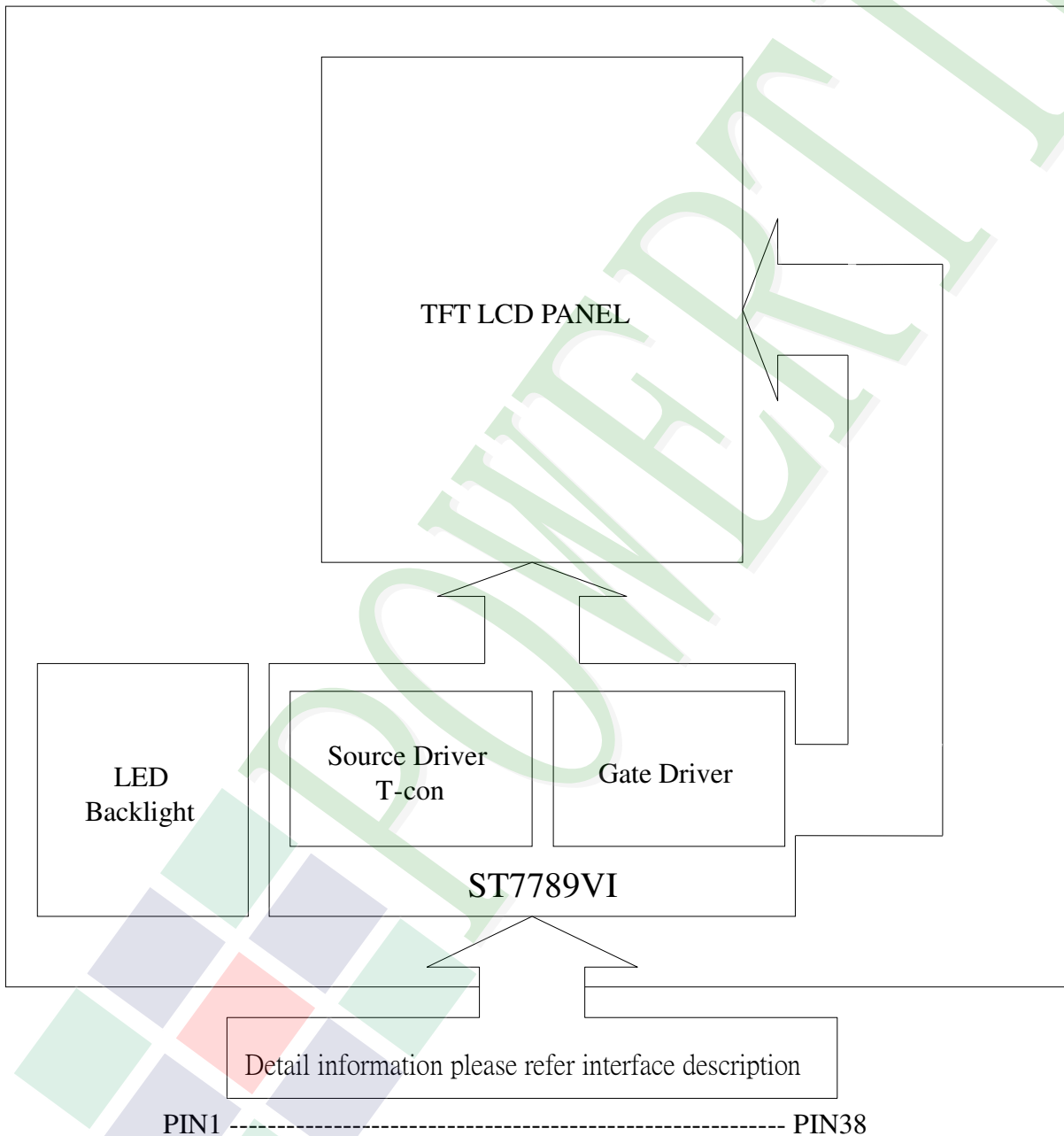

## Interface Pin Description

Pin No.	Symbol	Function
1	GND	System Ground.(0V)
2	RESET	This signal will reset the device and must be applied to properly initialize the chip. Signal is active low.
3	DB7	Bi-directional data bus.
4	DB6	Bi-directional data bus.
5	DB5	Bi-directional data bus.
6	DB4	Bi-directional data bus.
7	DB3	Bi-directional data bus.
8	DB2	Bi-directional data bus.
9	DB1	Bi-directional data bus.
10	DB0	Bi-directional data bus.
11	RD	Serves as a read signal and MCU read data at the rising edge.
12	/WR	Serves as a write signal and writes data at the rising edge.
13	RS	When RS = '1', data is selected. When RS = '0', command is selected.
14	/CS	Chip select input pin ("Low" enable).
15	NC	Not Connect.
16	NC	Not Connect.
17	NC	Not Connect.
18	NC	Not Connect.
19	NC	Not Connect.
20	NC	Not Connect.
21	NC	Not Connect.
22	NC	Not Connect.

Pin No.	Symbol	Function
23	NC	Not Connect.
24	NC	Not Connect.
25	NC	Not Connect.
26	NC	Not Connect.
27	NC	Not Connect.
28	NC	Not Connect.
29	NC	Not Connect.
30	NC	Not Connect.
31	NC	Not Connect.
32	NC	Not Connect.
33	NC	Not Connect.
34	LEDA	Power supply for LED Backlight Anode input.
35	LEDK1	Power supply for LED Backlight Cathode input.
36	LEDK2	Power supply for LED Backlight Cathode input.
37	LEDK3	Power supply for LED Backlight Cathode input.
38	VDD	Power supply.(2.8V) .

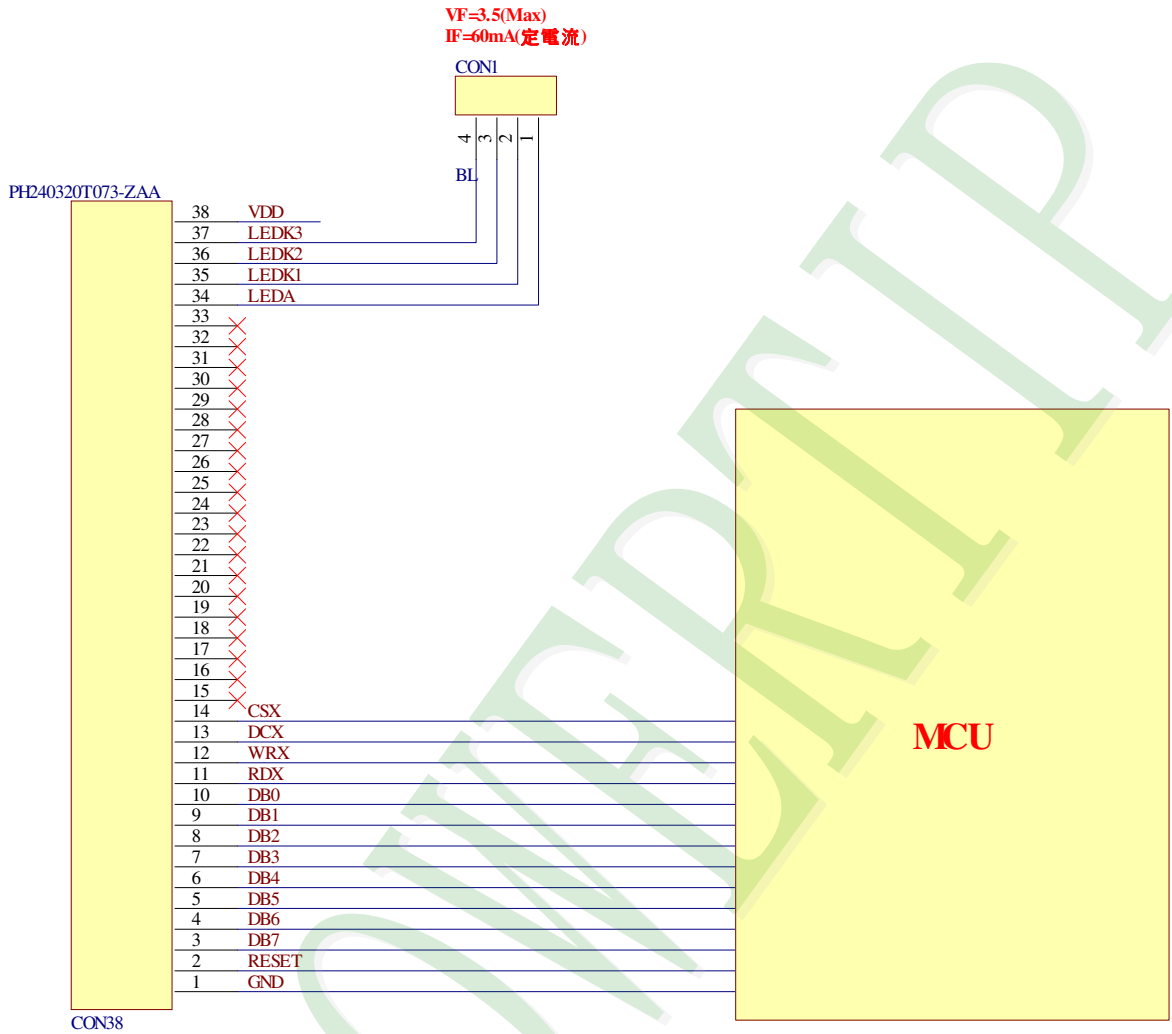
**Application Notes:**

## 2.2.2 Refer Initial code :

```
MOV    ADDRL,#11H
CALL   WRITE_COMMAND
CALL   DELAY
CALL   DELAY
CALL   DELAY
```

```
MOV    ADDRL,#36H
CALL   WRITE_COMMAND
MOV    ADDRL,#00H
CALL   WRITE_DATA
```

```
MOV    ADDRL,#3aH
CALL   WRITE_COMMAND
MOV    ADDRL,#05H
CALL   WRITE_DATA
```

```
MOV    ADDRL,#B2H
CALL   WRITE_COMMAND
MOV    ADDRL,#0CH
CALL   WRITE_DATA
MOV    ADDRL,#0CH
CALL   WRITE_DATA
MOV    ADDRL,#00H
CALL   WRITE_DATA
MOV    ADDRL,#33H
CALL   WRITE_DATA
MOV    ADDRL,#33H
CALL   WRITE_DATA
```

```
MOV    ADDRL,#B7H
CALL   WRITE_COMMAND
MOV    ADDRL,#35H
CALL   WRITE_DATA
```

```
MOV    ADDRL,#BBH
CALL   WRITE_COMMAND
MOV    ADDRL,#20H
CALL   WRITE_DATA
```

```
MOV    ADDRL,#C0H
CALL   WRITE_COMMAND
MOV    ADDRL,#2CH
CALL   WRITE_DATA
```

```
MOV    ADDRL,#C2H
CALL   WRITE_COMMAND
MOV    ADDRL,#01H
CALL   WRITE_DATA
```

```
MOV    ADDRL,#C3H
CALL   WRITE_COMMAND
MOV    ADDRL,#0bH
CALL   WRITE_DATA
```

```
MOV    ADDRL,#C4H
CALL   WRITE_COMMAND
MOV    ADDRL,#20H
CALL   WRITE_DATA
```

```
MOV    ADDRL,#C6H
CALL   WRITE_COMMAND
MOV    ADDRL,#0fH
CALL   WRITE_DATA
```

```
MOV    ADDRL,#D0H
CALL   WRITE_COMMAND
MOV    ADDRL,#A4H
CALL   WRITE_DATA
MOV    ADDRL,#A1H
CALL   WRITE_DATA
```

```
MOV    ADDRL,#E0H
CALL   WRITE_COMMAND
MOV    ADDRL,#F0H
CALL   WRITE_DATA
MOV    ADDRL,#06H
CALL   WRITE_DATA
MOV    ADDRL,#0AH
CALL   WRITE_DATA
MOV    ADDRL,#08H
CALL   WRITE_DATA
MOV    ADDRL,#07H
CALL   WRITE_DATA
MOV    ADDRL,#26H
CALL   WRITE_DATA
MOV    ADDRL,#2BH
CALL   WRITE_DATA
MOV    ADDRL,#34H
CALL   WRITE_DATA
MOV    ADDRL,#44H
CALL   WRITE_DATA
MOV    ADDRL,#36H
CALL   WRITE_DATA
MOV    ADDRL,#11H
CALL   WRITE_DATA
MOV    ADDRL,#12H
CALL   WRITE_DATA
MOV    ADDRL,#2DH
CALL   WRITE_DATA
MOV    ADDRL,#33H
CALL   WRITE_DATA
```

```
MOV    ADDRL,#E1H
CALL   WRITE_COMMAND
MOV    ADDRL,#F0H
CALL   WRITE_DATA
MOV    ADDRL,#03H
CALL   WRITE_DATA
MOV    ADDRL,#08H
CALL   WRITE_DATA
MOV    ADDRL,#09H
CALL   WRITE_DATA
MOV    ADDRL,#08H
CALL   WRITE_DATA
MOV    ADDRL,#03H
CALL   WRITE_DATA
MOV    ADDRL,#2DH
CALL   WRITE_DATA
MOV    ADDRL,#42H
CALL   WRITE_DATA
```

```
MOV    ADDR,#42H
CALL   WRITE_DATA
MOV    ADDR,#37H
CALL   WRITE_DATA
MOV    ADDR,#13H
CALL   WRITE_DATA
MOV    ADDR,#13H
CALL   WRITE_DATA
MOV    ADDR,#13H
CALL   WRITE_DATA
MOV    ADDR,#2FH
CALL   WRITE_DATA
MOV    ADDR,#35H
CALL   WRITE_DATA
```

```
MOV    ADDR,#21H
CALL   WRITE_COMMAND
```

```
MOV    ADDR,#29H
CALL   WRITE_COMMAND
```



## 2.3 Timing Characteristics

8080 Series MCU Parallel Interface Characteristics: 8 bit Bus

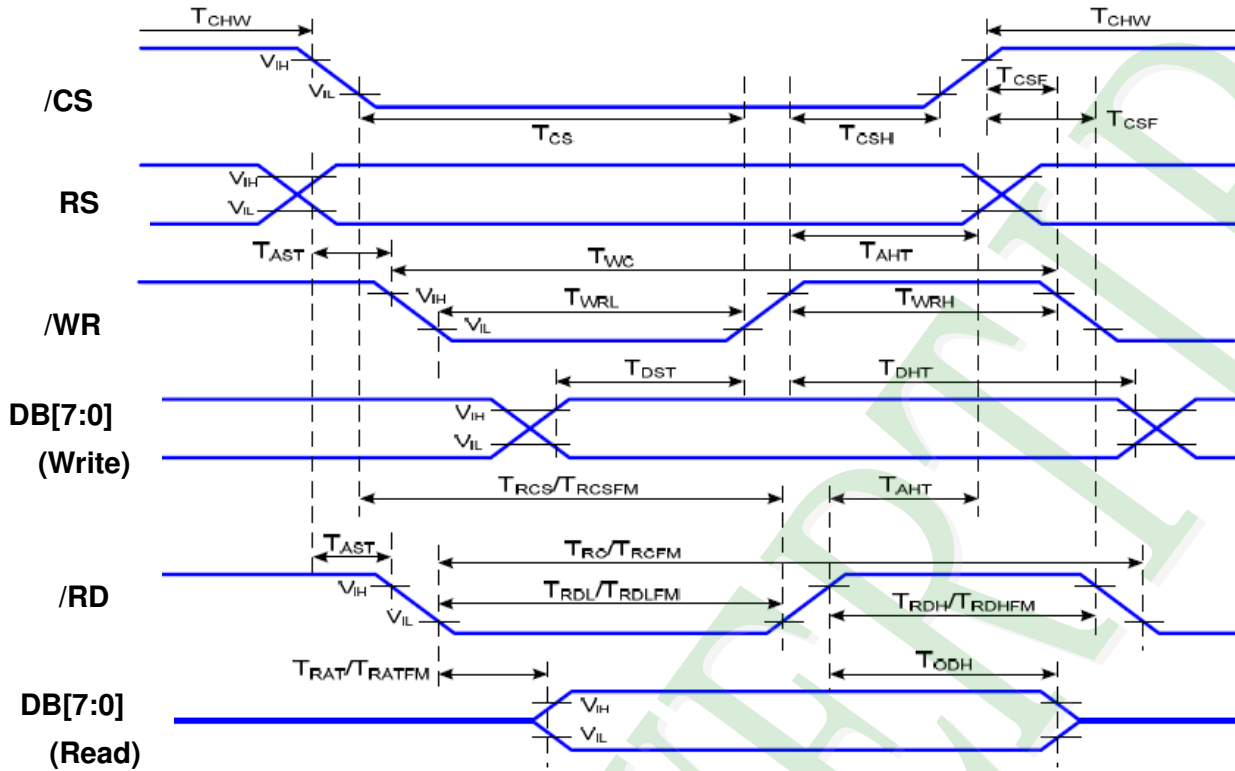

Figure 1 Parallel Interface Timing Characteristics (8080-Series MCU Interface)

VDDI=1.65 to 3.3V, VDD=2.4 to 3.3V, AGND=DGND=0V, Ta= -30 to 70 °C

Signal	Symbol	Parameter	Min	Max	Unit	Description
RS	T <sub>AST</sub>	Address setup time	0		ns	
	T <sub>AHT</sub>	Address hold time (Write/Read)	10		ns	
/CS	T <sub>CHW</sub>	Chip select "H" pulse width	0		ns	
	T <sub>CS</sub>	Chip select setup time (Write)	15		ns	
	T <sub>RCS</sub>	Chip select setup time (Read ID)	45		ns	
	T <sub>RCSFM</sub>	Chip select setup time (Read FM)	355		ns	
	T <sub>CSF</sub>	Chip select wait time (Write/Read)	10		ns	
	T <sub>CSH</sub>	Chip select hold time	10		ns	
/WR	T <sub>WC</sub>	Write cycle	66		ns	
	T <sub>WRH</sub>	Control pulse "H" duration	15		ns	
	T <sub>WRL</sub>	Control pulse "L" duration	15		ns	
/RD (ID)	T <sub>RC</sub>	Read cycle (ID)	160		ns	
	T <sub>RDH</sub>	Control pulse "H" duration (ID)	90		ns	When read ID data
	T <sub>RDL</sub>	Control pulse "L" duration (ID)	45		ns	
/RD (FM)	T <sub>RCFM</sub>	Read cycle (FM)	450		ns	
	T <sub>RDHF</sub>	Control pulse "H" duration (FM)	90		ns	When read from frame memory
	T <sub>RDLFM</sub>	Control pulse "L" duration (FM)	355		ns	
DB[7:0]	T <sub>DST</sub>	Data setup time	10		ns	For CL=30pF
	T <sub>DHT</sub>	Data hold time	10		ns	
	T <sub>RAT</sub>	Read access time (ID)		40	ns	
	T <sub>RATFM</sub>	Read access time (FM)		340	ns	
	T <sub>ODH</sub>	Output disable time	20	80	ns	

## Reset Timing

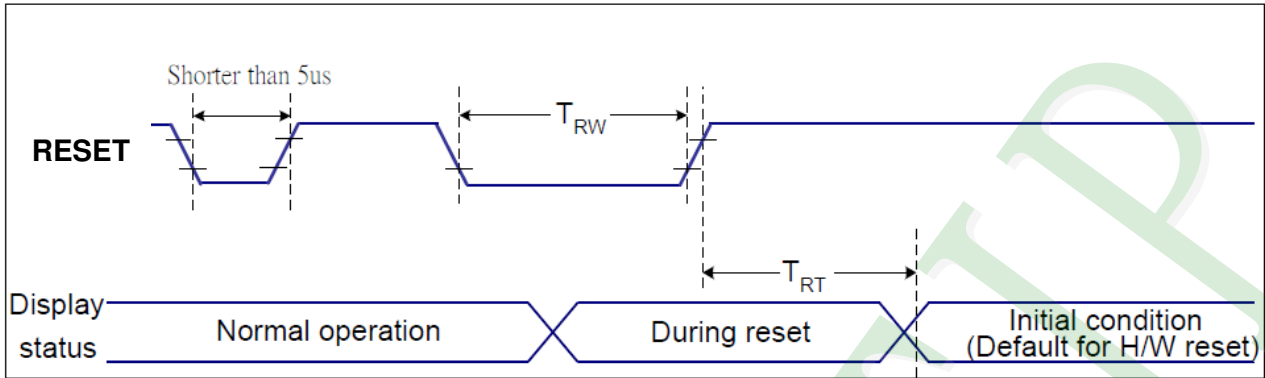

Figure 7 Reset Timing

VDDI=1.65 to 3.3V, VDD=2.4 to 3.3V, AGND=DGND=0V,  $T_a=-30 \sim 70 \text{ }^\circ\text{C}$

Related Pins	Symbol	Parameter	MIN	MAX	Unit
RESET	TRW	Reset pulse duration	10	-	us
	TRT	Reset cancel	-	5 (Note 1, 5)	ms
				120 (Note 1, 6, 7)	ms

Table 8 Reset Timing

Notes:

1. The reset cancel includes also required time for loading ID bytes, VCOM setting and other settings from NVM (or similar device) to registers. This loading is done every time when there is HW reset cancel time ( $t_{RT}$ ) within 5 ms after a rising edge of RESX.
2. Spike due to an electrostatic discharge on RESX line does not cause irregular system reset according to the table below:

RESX Pulse	Action
Shorter than 5us	Reset Rejected
Longer than 9us	Reset
Between 5us and 9us	Reset starts

3. During the Resetting period, the display will be blanked (The display is entering blanking sequence, which maximum time is 120 ms, when Reset Starts in Sleep Out –mode. The display remains the blank state in Sleep In –mode.) and then return to Default condition for Hardware Reset.
4. Spike Rejection also applies during a valid reset pulse as shown below:

### 3. QUALITY ASSURANCE SYSTEM

#### 3.1 Quality Assurance Flow Chart

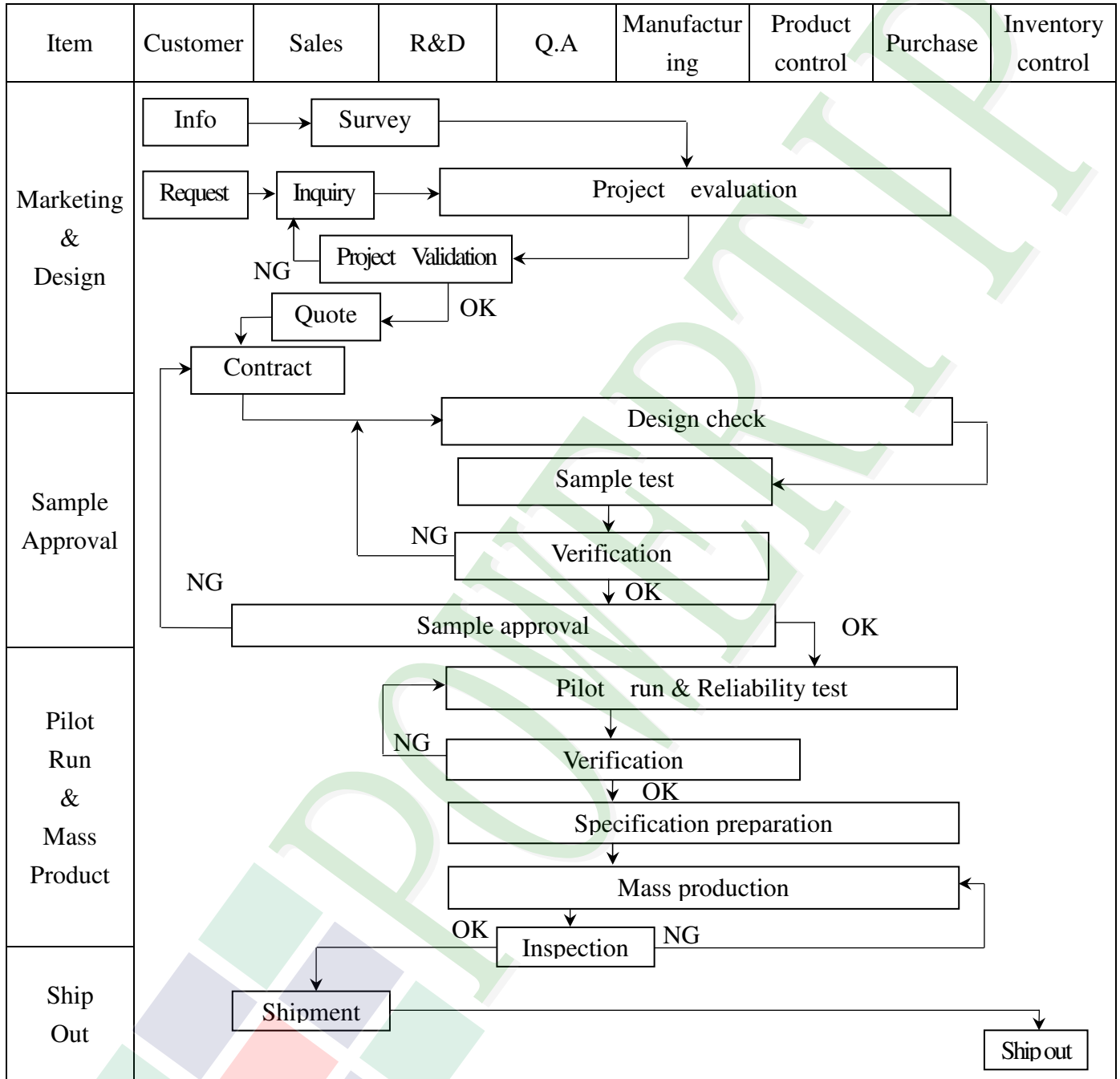

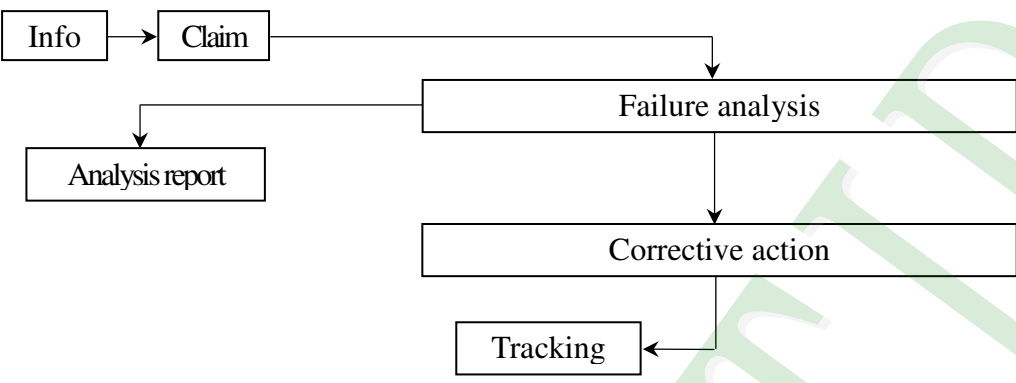
Item	Customer	Sales	R&D	Q.A	Manufacturing	Product control	Purchase	Inventory control
Sales Service	 <pre> graph TD     Info[Info] --&gt; Claim[Claim]     Claim --&gt; FA[Failure analysis]     Claim --&gt; AR[Analysis report]     FA --&gt; CA[Corrective action]     CA --&gt; Tracking[Tracking]           </pre>							
Q.A Activity	1. ISO 9001 Maintenance Activities 3. Equipment calibration 5. Standardization Management				2. Process improvement proposal 4. Education And Training Activities			

### 3.2. Inspection Specification

- ◆ Scope : The document shall be applied to TFT-LCD Module for less than 3.5" (Ver.B01).
- ◆ Inspection Standard : MIL-STD-105E Table Normal Inspection Single Sampling Level II .
- ◆ Equipment : Gauge 、 MIL-STD 、 Powertip Tester 、 Sample
- ◆ Defect Level : Major Defect AQL : 0.4 ; Minor Defect AQL : 1.5
- ◆ OUT Going Defect Level : Sampling.
- ◆ Standard of the product appearance test :

a. Manner of appearance test :

- (1). The test best be under 20W×2 fluorescent light , and distance of view must be at 30 cm.
- (2). The test direction is base on about around 45° of vertical line.

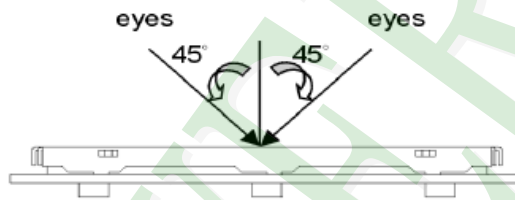

(3). Definition of area.

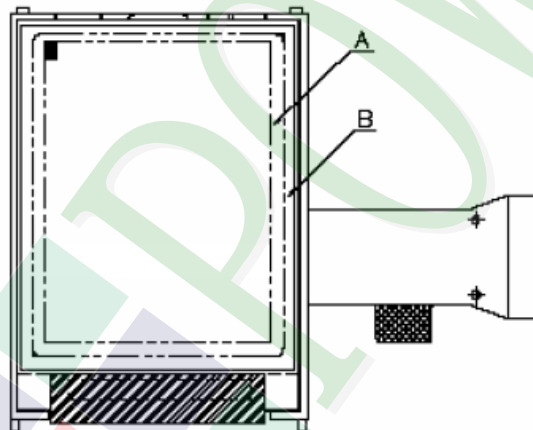

*A* area : viewing area

*B* area : Outside of viewing area

(4). Standard of inspection : (Unit : mm)

**◆ Specification For TFT-LCD Module Less Than 3.5" :**

(Ver.B01)

NO	Item	Criterion	Level										
01	Product condition	1. 1 The part number is inconsistent with work order of production.	Major										
		1. 2 Mixed product types.	Major										
		1. 3 Assembled in inverse direction.	Major										
02	Quantity	2. 1 The quantity is inconsistent with work order of production.	Major										
03	Outline dimension	3. 1 Product dimension and structure must conform to structure diagram.	Major										
04	Electrical Testing	4. 1 Missing line character and icon.	Major										
		4. 2 No function or no display.	Major										
		4. 3 Display malfunction.	Major										
		4. 4 LCD viewing angle defect.	Major										
		4. 5 Current consumption exceeds product specifications.	Major										
05	<b>Dot defect</b> (Bright dot 、 Dark dot)  On -display	<table border="1" style="margin-left: auto; margin-right: auto;"> <thead> <tr> <th>Item</th> <th>Acceptance (Q'ty)</th> </tr> </thead> <tbody> <tr> <td>Bright Dot</td> <td><math>\leq 2</math></td> </tr> <tr> <td>Dark Dot</td> <td><math>\leq 3</math></td> </tr> <tr> <td>Joint Dot</td> <td><math>\leq 2</math></td> </tr> <tr> <td>Total</td> <td><math>\leq 3</math></td> </tr> </tbody> </table>	Item	Acceptance (Q'ty)	Bright Dot	$\leq 2$	Dark Dot	$\leq 3$	Joint Dot	$\leq 2$	Total	$\leq 3$	Minor
		Item	Acceptance (Q'ty)										
		Bright Dot	$\leq 2$										
		Dark Dot	$\leq 3$										
		Joint Dot	$\leq 2$										
Total	$\leq 3$												
5. 1 Inspection pattern : full white , full black , Red , Green and blue screens.													
5. 2 It is defined as dot defect if defect area $> 1/2$ dot.													
5. 3 The distance between two dot defect $\geq 5$ mm.													

◆ Specification For TFT-LCD Module Less Than 3.5" :

(Ver.B01)

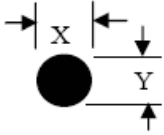
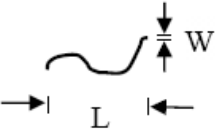
NO	Item	Criterion	Level																																												
06	<p>Black or white dot、scratch、contamination</p> <p>Round type</p>  <p><math>\Phi = (x + y) / 2</math></p> <p>Line type</p> 	<p>6.1 Round type ( Non-display or display) :</p> <table border="1" data-bbox="552 421 1321 875"> <thead> <tr> <th rowspan="2">Dimension (diameter : <math>\Phi</math>)</th> <th colspan="2">Acceptance (Q'ty)</th> </tr> <tr> <th>A area</th> <th>B area</th> </tr> </thead> <tbody> <tr> <td><math>\Phi \leq 0.15</math></td> <td colspan="2">Ignore</td> </tr> <tr> <td><math>0.15 &lt; \Phi \leq 0.20</math></td> <td colspan="2">2</td> </tr> <tr> <td><math>0.20 &lt; \Phi \leq 0.30</math></td> <td colspan="2">2</td> </tr> <tr> <td><math>\Phi &gt; 0.30</math></td> <td colspan="2">0</td> </tr> <tr> <td><b>Total</b></td> <td colspan="2"><b>3</b></td> </tr> </tbody> </table> <p>6.2 Line type( Non-display or display) :</p> <table border="1" data-bbox="533 987 1342 1402"> <thead> <tr> <th colspan="2">Dimension</th> <th colspan="2">Acceptance (Q'ty)</th> </tr> <tr> <th>Length (L)</th> <th>Width (W)</th> <th>A area</th> <th>B area</th> </tr> </thead> <tbody> <tr> <td>---</td> <td><math>W \leq 0.03</math></td> <td colspan="2">Ignore</td> </tr> <tr> <td><math>L \leq 5.0</math></td> <td><math>0.03 &lt; W \leq 0.05</math></td> <td colspan="2">3</td> </tr> <tr> <td>---</td> <td><math>W &gt; 0.05</math></td> <td colspan="2">As round type</td> </tr> <tr> <td colspan="2"><b>Total</b></td> <td colspan="2"><b>3</b></td> </tr> </tbody> </table>	Dimension (diameter : $\Phi$ )	Acceptance (Q'ty)		A area	B area	$\Phi \leq 0.15$	Ignore		$0.15 < \Phi \leq 0.20$	2		$0.20 < \Phi \leq 0.30$	2		$\Phi > 0.30$	0		<b>Total</b>	<b>3</b>		Dimension		Acceptance (Q'ty)		Length (L)	Width (W)	A area	B area	---	$W \leq 0.03$	Ignore		$L \leq 5.0$	$0.03 < W \leq 0.05$	3		---	$W > 0.05$	As round type		<b>Total</b>		<b>3</b>		Minor
Dimension (diameter : $\Phi$ )	Acceptance (Q'ty)																																														
	A area	B area																																													
$\Phi \leq 0.15$	Ignore																																														
$0.15 < \Phi \leq 0.20$	2																																														
$0.20 < \Phi \leq 0.30$	2																																														
$\Phi > 0.30$	0																																														
<b>Total</b>	<b>3</b>																																														
Dimension		Acceptance (Q'ty)																																													
Length (L)	Width (W)	A area	B area																																												
---	$W \leq 0.03$	Ignore																																													
$L \leq 5.0$	$0.03 < W \leq 0.05$	3																																													
---	$W > 0.05$	As round type																																													
<b>Total</b>		<b>3</b>																																													
07	Polarizer Bubble	<table border="1" data-bbox="544 1451 1334 1861"> <thead> <tr> <th rowspan="2">Dimension (diameter : <math>\Phi</math>)</th> <th colspan="2">Acceptance (Q'ty)</th> </tr> <tr> <th>A area</th> <th>B area</th> </tr> </thead> <tbody> <tr> <td><math>\Phi \leq 0.20</math></td> <td colspan="2">Ignore</td> </tr> <tr> <td><math>0.20 &lt; \Phi \leq 0.50</math></td> <td colspan="2">3</td> </tr> <tr> <td><math>\Phi &gt; 0.50</math></td> <td colspan="2">0</td> </tr> <tr> <td><b>Total</b></td> <td colspan="2"><b>3</b></td> </tr> </tbody> </table>	Dimension (diameter : $\Phi$ )	Acceptance (Q'ty)		A area	B area	$\Phi \leq 0.20$	Ignore		$0.20 < \Phi \leq 0.50$	3		$\Phi > 0.50$	0		<b>Total</b>	<b>3</b>		Minor																											
Dimension (diameter : $\Phi$ )	Acceptance (Q'ty)																																														
	A area	B area																																													
$\Phi \leq 0.20$	Ignore																																														
$0.20 < \Phi \leq 0.50$	3																																														
$\Phi > 0.50$	0																																														
<b>Total</b>	<b>3</b>																																														



**◆ Specification For TFT-LCD Module Less Than 3.5" :**

(Ver.B01)

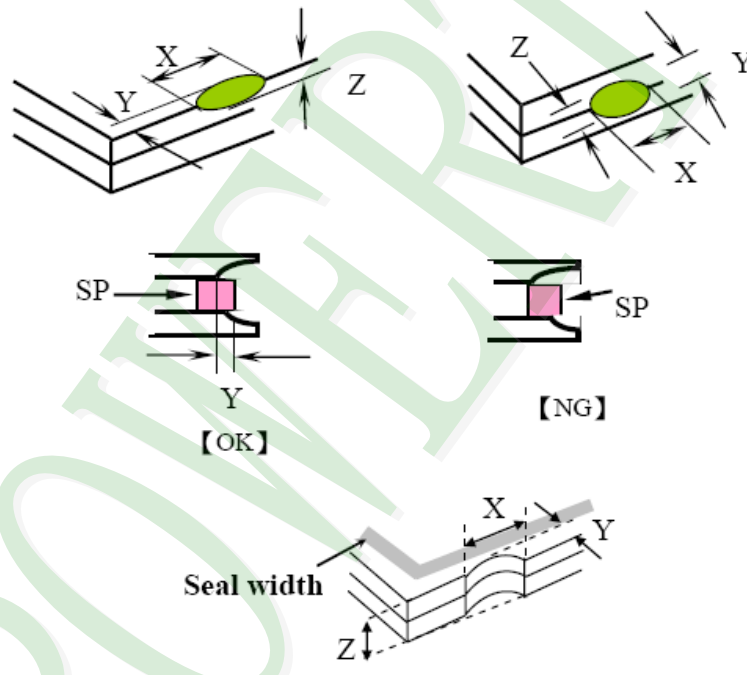
NO	Item	Criterion	Level									
08	The crack of glass	<p><b>Symbols :</b></p> <p><b>X :</b> The length of crack  <b>Z :</b> The thickness of crack  <b>t :</b> The thickness of glass</p> <p><b>Y :</b> The width of crack.  <b>W :</b> terminal length  <b>a :</b> LCD side length</p> <hr/> <p>8.1 General glass chip :</p> <p>8.1.1 Chip on panel surface and crack between panels:</p>  <table border="1" data-bbox="550 1444 1348 1724"> <thead> <tr> <th>X</th> <th>Y</th> <th>Z</th> </tr> </thead> <tbody> <tr> <td><math>\leq a</math></td> <td>Crack can't enter viewing area</td> <td><math>\leq 1/2 t</math></td> </tr> <tr> <td><math>\leq a</math></td> <td>Crack can't exceed the half of SP width.</td> <td><math>1/2 t &lt; Z \leq 2 t</math></td> </tr> </tbody> </table>	X	Y	Z	$\leq a$	Crack can't enter viewing area	$\leq 1/2 t$	$\leq a$	Crack can't exceed the half of SP width.	$1/2 t < Z \leq 2 t$	Minor
		X	Y	Z								
$\leq a$	Crack can't enter viewing area	$\leq 1/2 t$										
$\leq a$	Crack can't exceed the half of SP width.	$1/2 t < Z \leq 2 t$										

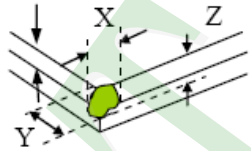
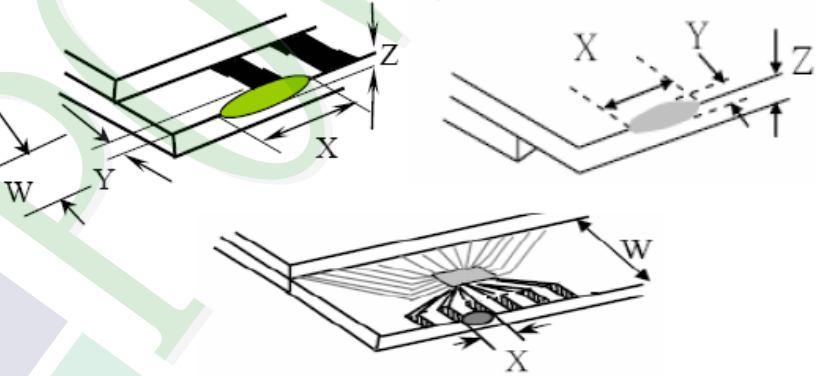

NO	Item	Criterion	Level										
08	The crack of glass	<p>Symbols :</p> <p>X : The length of crack                      Y : The width of crack.                      Z : The thickness of crack                      W : terminal length                      t : The thickness of glass                      a : LCD side length</p> <hr/> <p>8.1.2 Corner crack :</p>  <table border="1" data-bbox="533 775 1337 1061"> <thead> <tr> <th>X</th> <th>Y</th> <th>Z</th> </tr> </thead> <tbody> <tr> <td><math>\leq 1/5 a</math></td> <td>Crack can't enter viewing area</td> <td><math>Z \leq 1/2 t</math></td> </tr> <tr> <td><math>\leq 1/5 a</math></td> <td>Crack can't exceed the half of SP width.</td> <td><math>1/2 t &lt; Z \leq 2 t</math></td> </tr> </tbody> </table>	X	Y	Z	$\leq 1/5 a$	Crack can't enter viewing area	$Z \leq 1/2 t$	$\leq 1/5 a$	Crack can't exceed the half of SP width.	$1/2 t < Z \leq 2 t$	Minor	
		X	Y	Z									
$\leq 1/5 a$	Crack can't enter viewing area	$Z \leq 1/2 t$											
$\leq 1/5 a$	Crack can't exceed the half of SP width.	$1/2 t < Z \leq 2 t$											
<p>8.2 Protrusion over terminal :</p> <p>8.2.1 Chip on electrode pad :</p>  <table border="1" data-bbox="571 1659 1347 1832"> <thead> <tr> <th></th> <th>X</th> <th>Y</th> <th>Z</th> </tr> </thead> <tbody> <tr> <td>Front</td> <td><math>\leq a</math></td> <td><math>\leq 1/2 W</math></td> <td><math>\leq t</math></td> </tr> <tr> <td>Back</td> <td><math>\leq a</math></td> <td><math>\leq W</math></td> <td><math>\leq 1/2 t</math></td> </tr> </tbody> </table>		X	Y	Z	Front	$\leq a$	$\leq 1/2 W$	$\leq t$	Back	$\leq a$	$\leq W$	$\leq 1/2 t$	
	X	Y	Z										
Front	$\leq a$	$\leq 1/2 W$	$\leq t$										
Back	$\leq a$	$\leq W$	$\leq 1/2 t$										

**◆ Specification For TFT-LCD Module Less Than 3.5" :**

(Ver.B01)

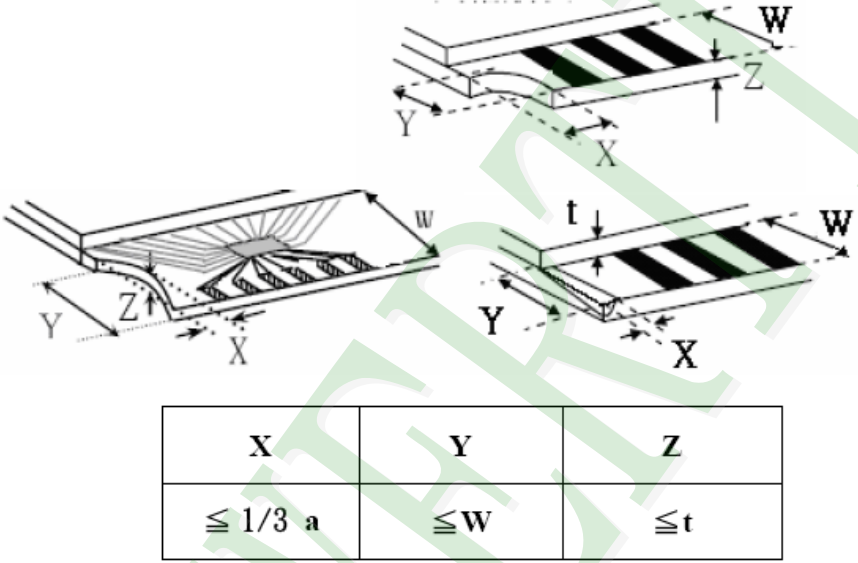
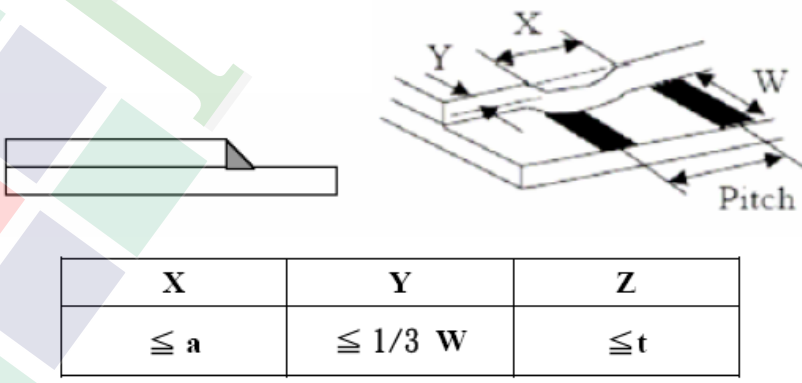
NO	Item	Criterion	Level
08	The crack of glass	Symbols : X : The length of crack Y : The width of crack. Z : The thickness of crack W : terminal length t : The thickness of glass a : LCD side length	Minor
		8.2.2 Non-conductive portion :  <p>⊙ If the chipped area touches the ITO terminal, over 2/3 of the ITO must remain and be inspected according to electrode terminal specifications.</p> 8.2.3 Glass remain : 	

**◆ Specification For TFT-LCD Module Less Than 3.5" :**

(Ver.B01)

NO	Item	Criterion	Level
09	Backlight elements	9. 1 Backlight can't work normally.	Major
		9. 2 Backlight doesn't light or color is wrong.	Major
		9. 3 Illumination source flickers when lit.	Major
10	General appearance	10. 1 Pin type 、 quantity 、 dimension must match type in structure diagram.	Major
		10. 2 No short circuits in components on PCB or FPC .	Major
		10. 3 Parts on PCB or FPC must be the same as on the production characteristic chart .There should be no wrong parts , missing parts or excess parts.	Major
		10. 4 Product packaging must the same as specified on packaging specification sheet.	Minor
		10. 5 The folding and peeled off in polarizer are not acceptable.	Minor
		10. 6 The PCB or FPC between B/L assembled distance(PCB or FPC ) is $\leq 1.5$ mm.	Minor



## 5. PRECAUTION RELATING PRODUCT HANDLING

### 5.1 SAFETY

- 5.1.1 If the LCD panel breaks , be careful not to get the liquid crystal to touch your skin.
- 5.1.2 If the liquid crystal touches your skin or clothes , please wash it off immediately by using soap and water.

### 5.2 HANDLING

- 5.2.1 Avoid any strong mechanical shock which can break the glass.
- 5.2.2 Avoid static electricity which can damage the CMOS LSI—When working with the module , be sure to ground your body and any electrical equipment you may be using.
- 5.2.3 Do not remove the panel or frame from the module.
- 5.2.4 The polarizing plate of the display is very fragile. So , please handle it very carefully ,do not touch , push or rub the exposed polarizing with anything harder than an HB pencil lead (glass , tweezers , etc.)
- 5.2.5 Do not wipe the polarizing plate with a dry cloth , as it may easily scratch the surface of plate.
- 5.2.6 Do not touch the display area with bare hands , this will stain the display area.
- 5.2.7 Do not use ketonics solvent & aromatic solvent. Use with a soft cloth soaked with a cleaning naphtha solvent.
- 5.2.8 To control temperature and time of soldering is  $320\pm 10^{\circ}\text{C}$  and 3-5 sec.
- 5.2.9 To avoid liquid (include organic solvent) stained on LCM .

### 5.3 STORAGE

- 5.3.1 Store the panel or module in a dark place where the temperature is  $25^{\circ}\text{C} \pm 5^{\circ}\text{C}$  and the humidity is below 65% RH.
- 5.3.2 Do not place the module near organics solvents or corrosive gases.
- 5.3.3 Do not crush , shake , or jolt the module.

### 5.4 TERMS OF WARRANTY

- 5.4.1 Applicable warrant period  
The period is within Twenty-four months since the date of shipping out under normal using and storage conditions.
- 5.4.2 Unaccepted responsibility  
This product has been manufactured to your company's specification as a part for use in your company's general electronic products. It is guaranteed to perform according to delivery specifications. For any other use apart from general electronic equipment , we cannot take responsibility if the product is used in nuclear power control equipment , aerospace equipment , fire and security systems or any other applications in which there is a direct risk to human life and where extremely high levels of reliability are required.

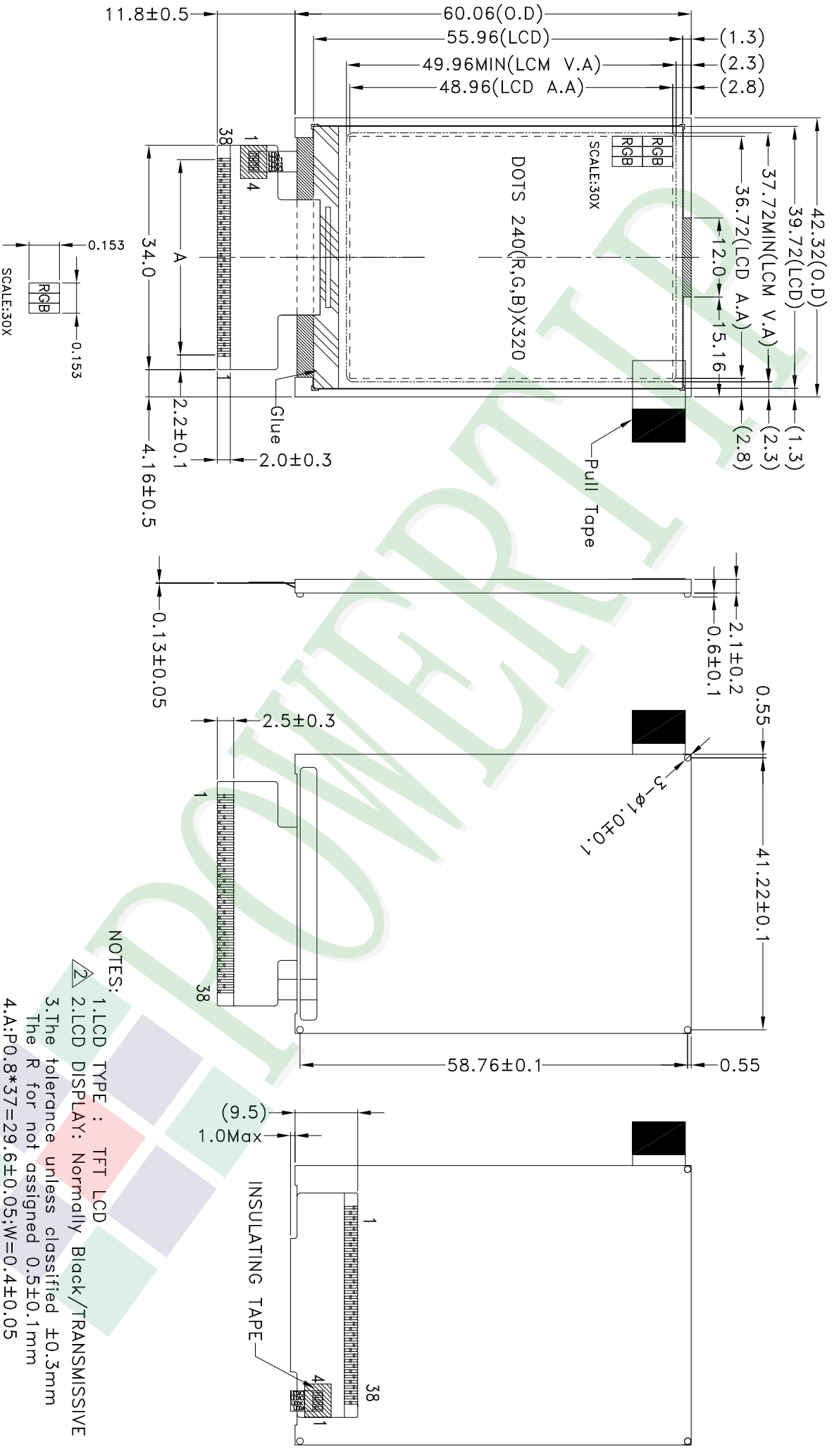

NOTES:

- 1.LCD TYPE : TFT LCD
- 2.LCD DISPLAY: Normally Black/TRANSMISSIVE
- 3.The tolerance unless classified ±0.3mm
- 4.A:P:0.8\*37=29.6±0.05;W=0.4±0.05

PART NO:  
PH240320T073-ZAA

久正光电股份有限公司  
POWER TIP TECHNOLOGY CORPORATION

DRAWING NAME:  
LMD-PH240320T073-ZAA

Design: Bob Zhang  
Check: Tina Chen

Surface: Material  
Unit: MM  
Scale: FIT

007			
006			
005			
004			
003			
002	Modify LCD display from Normal white to Normally Black	Tina	2019/08/01
001	NEW DRAWING	Bob	2018/07/30
REV	REV BY	REVISER	DATE

TITLE:  
LCD MODULE DRAWING

Approve: Jimmy Chen

Page: 1/1  
Quantity: -

Resolution (mm)	Precision Level
1 ~ 4	-
4 ~ 16	-
16 ~ 63	-
63 ~ 250	-
250 ~ 1000	-



# LCM包裝規格書

## LCM Packaging Specifications

Documents NO. PKG-PH240320T073-ZAA

Approve	Check	Contact
Jimmy Chen	Jimmy Chen	Tina Chen

## 1. 包裝材料規格表 (Packaging Material) : (per carton)

No.	Item	Model	Dimensions (mm)	1Pcs Weight	Quantity	Total Weight
1	成品 (LCM)	PH240320T073-ZAA	42.32 X 60.06	0.0075	468	3.51
2	靜電袋(1)Antistatic Bag	BAG100100ARABA	100 X 100	0.0011	468	0.5148
3	氣泡袋(2)Bubble Bag	BAG100065BRABA	100 X 65	0.0008	468	0.3744
4	A1-1隔板(3)A1-1 Partition	BX29500047BZBA	295 X 47 X 3	0.0078	168	1.3104
5	B1-1隔板(4)B1-1 Partition	BX24500047BZBA	245 X 47 X 3	0.0065	48	0.312
6	氣泡紙(5)Bubble Sheet	BAG280240BWABA	280 X 240	0.006	24	0.144
7	C1內盒(6)Product Box	BX31025555AABA	310 X 255 X 55	0.13	12	1.56
8	外紙箱(7)Carton	BX52732536CCBA	527 X 325 X 360	0.83	1	0.83
9						

2. 一整箱總重量 (Total LCD Weight in carton) : 8.56 Kg±10%

3. 單箱數量規格表 (Packaging Specifications and Quantity) :

(1)Quantity Of Spacer : A1-1隔板 X 14 , B1-1隔板 X 4

(2)Total LCM quantity in carton : quantity per box 39 x no of boxes 12 = 468

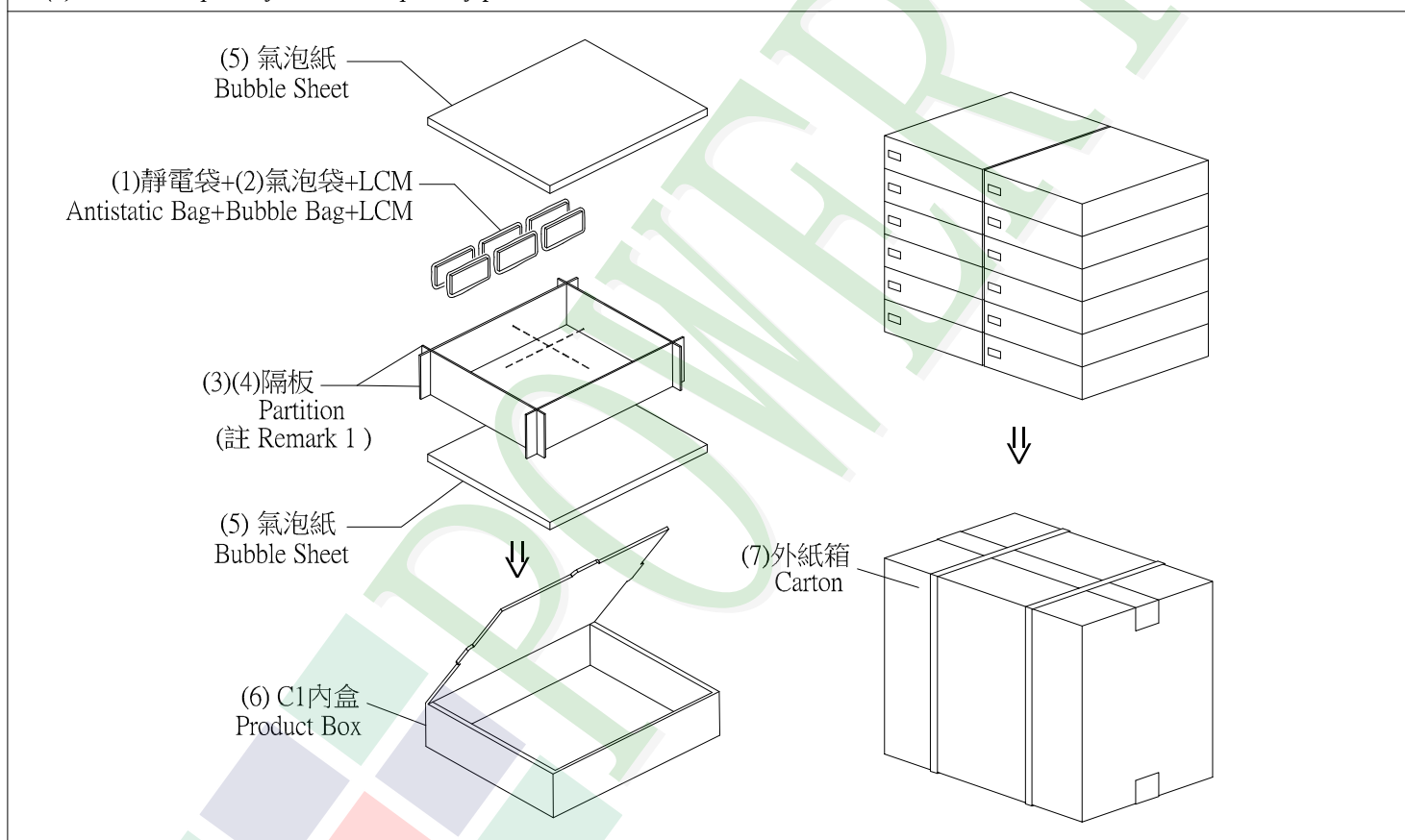

## 特 記 事 項 (REMARK)

4. LCM排放示意圖(前後間隔不放置):

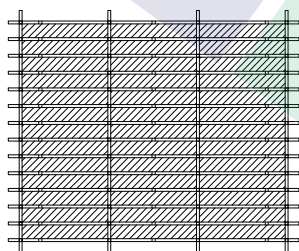
4. LCM placed as figure showing:  
( First and last slot should be empty)

▨ 模組(LCM) X 1pcs.