



# SPECIFICATION

---



PH800480T028-ZFA

4.3" - WVGA - RGB

Version: 00.5  
Date: 28.11.2019

Note: This specification is subject to change without prior notice



## SPECIFICATIONS

CUSTOMER : \_\_\_\_\_

SAMPLE CODE : SH800480T028-ZFA

MASS PRODUCTION CODE : PH800480T028-ZFA

SAMPLE VERSION : 01

SPECIFICATIONS EDITION : 005

DRAWING NO. (Ver.) : LMD-PH800480T028-ZFA(Ver.001)

PACKAGING NO. (Ver.) : PKG-PH800480T028-ZFA(Ver.001)

**Customer Approved**

---

**Date:**

Approved	Checked	Designer
廖志豪 Rex Liao	張慶源 Yuan Chang	陳宗淇 Howard Chen

- Preliminary specification for design input
- Specification for sample approval



### POWERTIP TECH. CORP.

**Headquarters:**

No.8, 6<sup>th</sup> Road, Taichung Industrial Park,  
Taichung, Taiwan  
台中市 407 工業區六路 8 號

TEL: 886-4-2355-8168

FAX: 886-4-2355-8166

E-mail: [sales@powertip.com.tw](mailto:sales@powertip.com.tw)

Http://www.powertip.com.tw





## Contents

### 1. SPECIFICATIONS

- 1.1 Features
- 1.2 Mechanical Specifications
- 1.3 Absolute Maximum Ratings
- 1.4 DC Electrical Characteristics
- 1.5 Optical Characteristics
- 1.6 Backlight Characteristics

### 2. MODULE STRUCTURE

- 2.1 Counter Drawing
- 2.2 Interface Pin Description
- 2.3 Timing Characteristics

### 3. QUALITY ASSURANCE SYSTEM

- 3.1 Quality Assurance Flow Chart
- 3.2 Inspection Specification

### 4. RELIABILITY TEST

- 4.1 Reliability Test Condition

### 5. PRECAUTION RELATING PRODUCT HANDLING

- 5.1 Safety
- 5.2 Handling
- 5.3 Storage
- 5.4 Terms of Warranty

Appendix : 1.LCM Drawing

2. Packing Specification

Note : For detailed information please refer to IC data sheet :

Primacy(TFT LCD): ILITEK: ILI6128B & ILI5960

## 1. SPECIFICATIONS

### 1.1 Features

Item	Standard Value
Display Type	800 * 3 (RGB) * 480 Dots
LCD Type	IPS TFT , Normally Black , Transmissive type
Screen size(inch)	4.3 inch
Color configuration	RGB-Strip
Backlight Type	White LED B/L
Interface	Digital 24-bits RGB Interface
Other(controller/driver IC)	ILI6128BT (Source IC) & ILI5960T (Gate IC) (Or Compatible IC)
ROHS	THIS PRODUCT CONFORMS THE ROHS OF PTC Detail information please refer website : <a href="http://www.powertip.com.tw/news_detail.php?Key=1&amp;cID=1">http://www.powertip.com.tw/news_detail.php?Key=1&amp;cID=1</a>

Note:

### 1.2 Mechanical Specifications

Item	Standard Value	Unit
Outline Dimension	105.5(W) * 67.2(L) * 2.6(H)	mm

#### LCD Panel

Item	Standard Value	Unit
Active Area	95.04(W) * 53.856(L)	mm
Pixel Size	0.1188(W) * 0.1122 (H)	mm

Note : For detailed information please refer to LCM drawing

### 1.3 Absolute Maximum Ratings

#### Module

Item	Symbol	Condition	Min.	Max.	Unit
System Power Supply Voltage	DVDD	GND=0	-0.5	5.0	V
Operating Temperature	T <sub>OP</sub> (Ts)	Note 1	-30	80	°C
Storage Temperature	T <sub>ST</sub> (Ta)	Note 2	-40	85	°C
Storage Humidity	H <sub>D</sub>	Ta ≤ 60 °C	20	90	%RH

The absolute maximum rating values of this product are not allowed to be exceeded at any times. Should a module be used with any of the absolute maximum ratings exceeded, the characteristics of the module may not be recovered, or in an extreme case, the module may be permanently destroyed.

Note 1 : Ts is the temperature of panel's surface.

Note 2 : Ta is the ambient temperature of samples.

### 1.4 DC Electrical Characteristics

#### Module

GND = 0V, Ta = 25°C

Item	Symbol	Condition	Min.	Typ.	Max.	Unit
Power Supply Voltage	DVDD	-	-	3.3	-	V
	V <sub>GH</sub>	-	14.5	15.0	15.5	
	V <sub>GL</sub>	-	-9.5	-10.0	-10.5	
	AV <sub>DD</sub>	-	12.0	12.5	13.0	
VCOM*2	V <sub>COM</sub>	-	3.5	4.5	5.5	V
Input H/L Level Voltage	V <sub>IH</sub>	-	0.7DVDD	-	DVDD	V
	V <sub>IL</sub>	-	GND	-	0.3DVDD	V
Supply Current	I <sub>dd</sub>	DVDD =3.3V Pattern=Picture	-	39	-	mA
		DVDD =3.3V Pattern= Black*1	-	40	60	mA

Note1:Maximum current display

Note2:Vcom must be adjusted to optimize display quality\_Cross talk, Contrast Ratio and etc.

## 1.5 Optical Characteristics

### TFT LCD Module

DVDD = 3.3 V, Ta=25°C

Item	Symbol		Condition	Min.	Typ.	Max.	unit	
Response time	Tr+Tf		Ta = 25°C θX, θY = 0°	-	41	62	ms	Note 2
Viewing angle	Top	θY+	CR ≥ 10	-	80	-	Deg.	Note 4
	Bottom	θY-		-	80	-		
	Left	θX-		-	80	-		
	Right	θX+		-	80	-		
Contrast ratio		CR		650	800	-		Note 3
Color of CIE Coordinate ( With B/L )	White	X	Ta = 25°C θX , θY = 0°	0.28	0.33	-0.38	-	Note1
		Y		0.31	0.36	0.41		
	Red	X		0.56	0.61	0.66		
		Y		0.31	0.36	0.41		
	Green	X		0.32	0.37	0.42		
		Y		0.53	0.58	0.63		
	Blue	X		0.09	0.14	0.19		
		Y		0.08	0.13	0.18		
Average Brightness Pattern=white display (With LCD )*1	IF		IF= 40 mA	<b>430</b>	<b>500</b>	-	cd/m <sup>2</sup>	Note1
Uniformity (With LCD )*2	ΔB		IF= 40mA	70	-	-	%	Note1

Note 1:

\*1 :  $\Delta B = B(\min) / B(\max) * 100\%$

\*2 : Measurement Condition for Optical Characteristics:

a : Environment:  $25^{\circ}\text{C} \pm 5^{\circ}\text{C}$  /  $60 \pm 20\%$  R.H , no wind , dark room below 10 Lux at typical lamp current and typical operating frequency.

b : Measurement Distance:  $500 \pm 50$  mm , ( $\theta = 0^{\circ}$ )

c : Equipment: TOPCON BM-7 fast , (field  $1^{\circ}$ ) , after 10 minutes operation.

d : The uncertainty of the C.I.E coordinate measurement  $\pm 0.01$  , Average Brightness  $\pm 4\%$

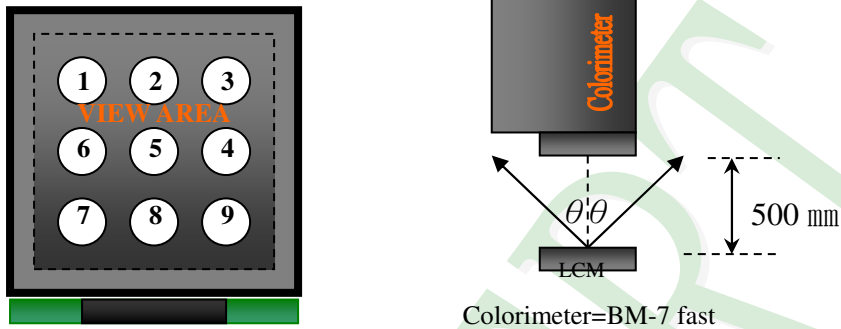

To be measured at the center area of panel with a viewing cone of  $1^{\circ}$  by Topcon luminance meter BM-7, after 10 minutes operation (module)

Note2: Definition of response time:

The output signals of photo detector are measured when the input signals are changed from "black" to "white"(falling time) and from "white" to "black"(rising time), respectively. The response time is defined as the time interval between the 10% and 90% of Amplitudes.

Refer to figure as below:

Normally White





### Normally Black

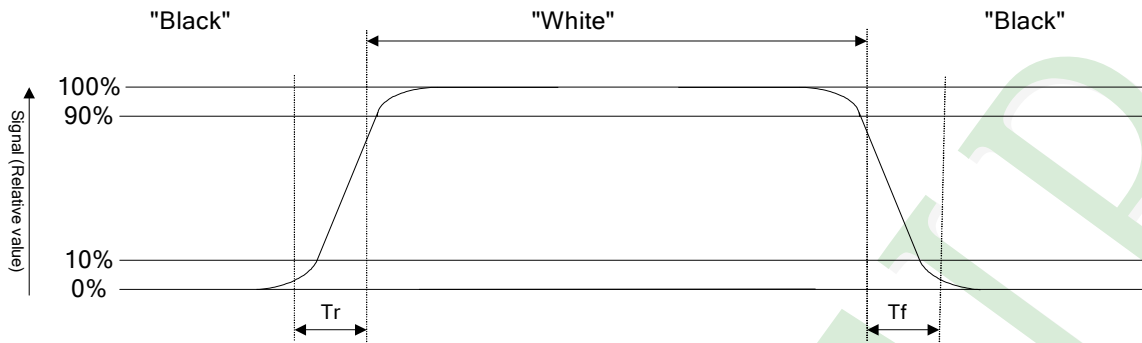

Note3: Definition of contrast ratio:

Contrast ratio is calculated with the following formula

$$\text{Contrast ratio (CR)} = \frac{\text{Photo detector output when LCD is at "White" state}}{\text{Photo detector output when LCD is at "Black" state}}$$

Note4: Definition of viewing angle:

Refer to figure as below:

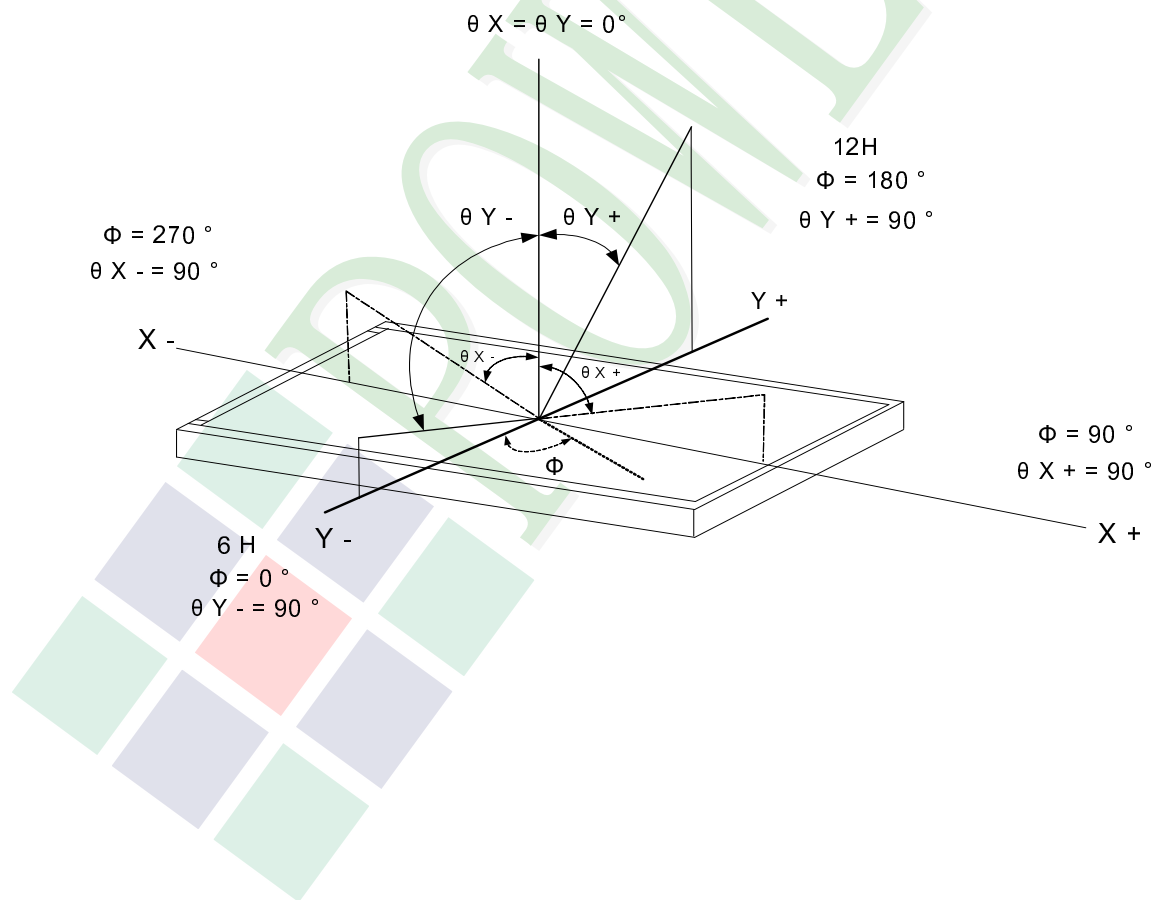

## 1.6 Backlight Characteristics

### Maximum Ratings

Item	Symbol	Conditions	Min.	Max.	Unit
LED Forward Current	IF	Ta =25°C	-	60	mA
LED Reverse Voltage	VR		-	1.2	V
Power consumption	Pd			1224	mW

### Electrical / Optical Characteristics

Item	Symbol	Conditions	Min.	Typ.	Max.	Unit
Forward Voltage	VF	If= 40mA	17.6	19.2	20.4	
Average Brightness (Without LCD)	IV		9500	11000	-	cd/m <sup>2</sup>
CIE Color Coordinate (Without LCD)	X			0.29		-
	Y			0.29		
Color	White					

B/L Internal Circuit Diagram:

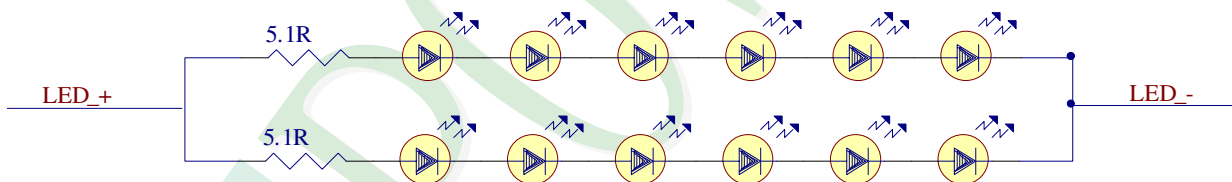

### Other Description

Item	Conditions	Description
Life Time	Ta =25°C IF= 40mA	50,000 hrs

## 2. MODULE STRUCTURE

### 2.1 Counter Drawing

#### 2.1.1 LCM Mechanical Diagram

\* See Appendix

#### 2.1.2 Block Diagram

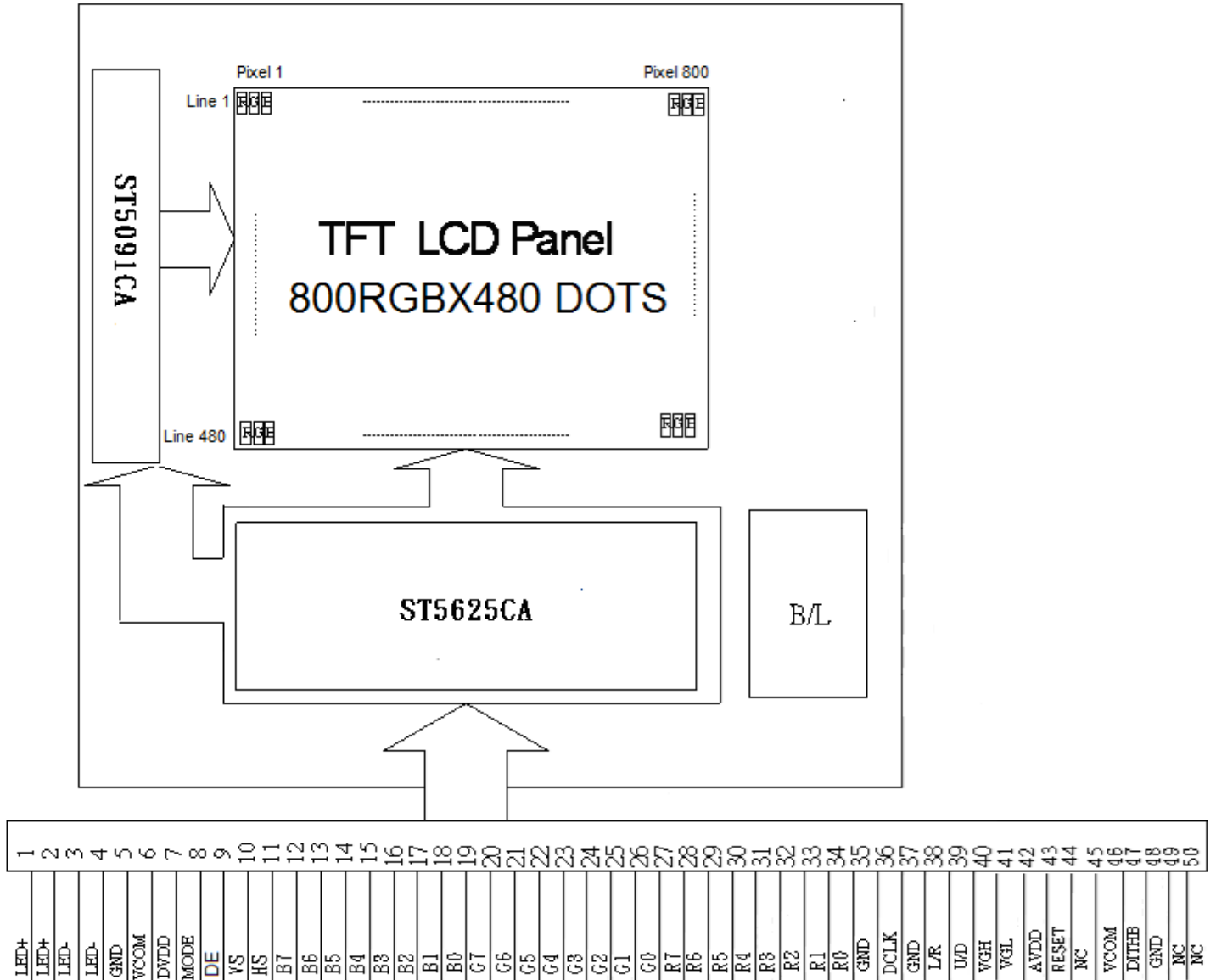

## 2.2 Interface Pin Description

Pin#	Name	DESCRIPTION
1	V <sub>LED+</sub>	Power For LED backlight (+).
2	V <sub>LED+</sub>	Power For LED backlight (+).
3	V <sub>LED-</sub>	Power For LED backlight (-).
4	V <sub>LED-</sub>	Power For LED backlight (-).
5	GND	Power ground.
6	V <sub>com</sub>	Common voltage.
7	DV <sub>DD</sub>	Power for Digital Circuit.
8	MODE	DE/SYNC mode select.
9	DE	Data Input Enable.
10	VS	Vertical Sync Input.
11	HS	Horizontal Sync Input.
12	B7	Blue Data(MSB).
13	B6	Blue Data.
14	B5	Blue Data.
15	B4	Blue Data.
16	B3	Blue Data.
17	B2	Blue Data.
18	B1	Blue Data.
19	B0	Blue Data(LSB).
20	G7	Green Data(MSB).
21	G6	Green Data.
22	G5	Green Data.
23	G4	Green Data.
24	G3	Green Data.
25	G2	Green Data.
26	G1	Green Data.
27	G0	Green Data(LSB).
28	R7	Red Data(MSB).
29	R6	Red Data.

Pin#	Name	DESCRIPTION
30	R5	Red Data.
31	R4	Red Data.
32	R3	Red Data.
33	R2	Red Data.
34	R1	Red Data.
35	R0	Red Data(LSB).
36	GND	Power Ground
37	DCLK	Sample clock, latch data at falling edge
38	GND	Power Ground.
39	L/R	Left / right selection.
40	U/D	Up / Down selection.
41	V <sub>GH</sub>	Gate On Voltage.
42	V <sub>GL</sub>	Gate OFF Voltage.
43	AV <sub>DD</sub>	Power for Analog Circuit.
44	RESET	Global reset pin.
45	NC	No connection.
46	V <sub>COM</sub>	Common Voltage.
47	DITHB	Dithering Function.
48	GND	Power Ground.
49	NC	No connection.
50	NC	No connection.



## 2.3 Timing Characteristics

### 2.3.1 Input Clock and Data Timing Diagram

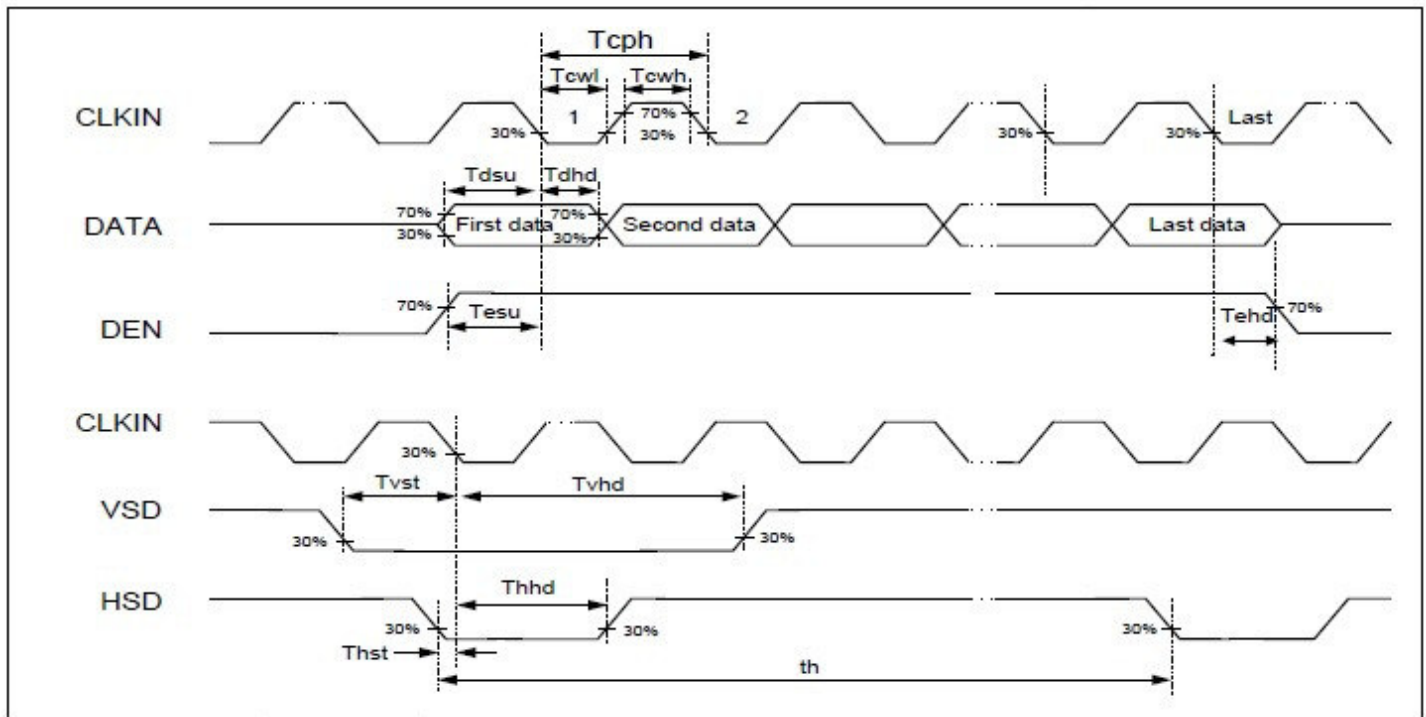

Parameter	Symbol	Min	Typ	Max	Unit	
CLKIN Frequency	Fclk	--	33	50	MHz	VDD = 2.7V ~3.6V
CLKIN Cycle Time	Tclk	20	30		ns	
CLKIN Pulse Duty	Tcwh	40	50	60	%	Tclk
Time from HSD to Source Output	Thso		<b>37</b>		CLKIN	
Time from HSD to LD	Thld		20		CLKIN	
Time from HSD to STV	Thstv		2		CLKIN	
Time from HSD to CKV	Thckv		20		CLKIN	
Time from HSD to OEV	Thoev		4		CLKIN	
LD Pulse Width	Twld		16		<b>CLKIN</b>	
CKV Pulse Width	Twckv		66		CLKIN	
OEV Pulse Width	Twoev		74		CLKIN	

## 2.3.2 Timing Characteristic

### Horizontal input timing

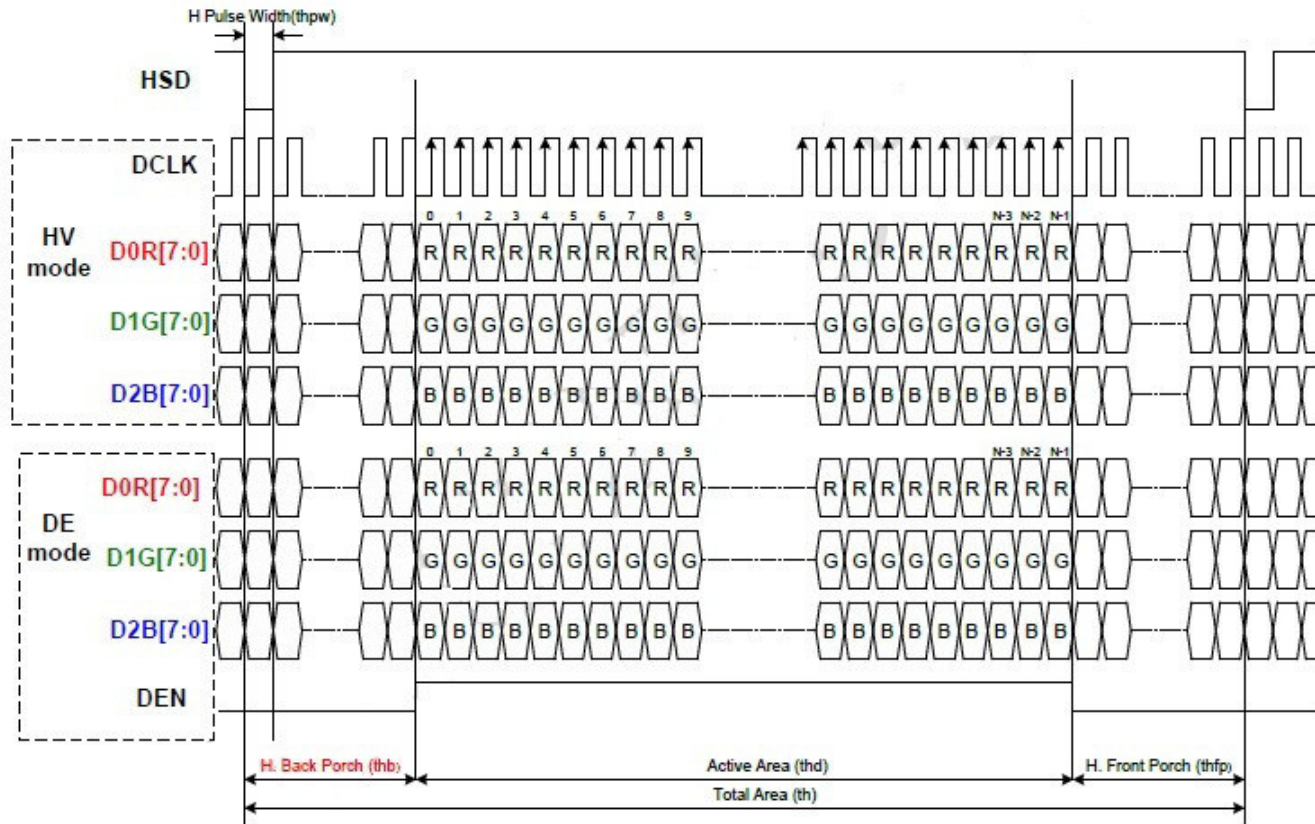

Parameter	Symbol	Value			Unit
		Min	Typ	Max	
Horizontal display area	thd		800		DCLK
DCLK frequency	fclk	-	30	50	MHz
One Horizontal Line	th	862	1056	1200	DCLK
HS pulse width	thpw	1	--	40	
HS Back Porch (Blacking)	thp		46		
HS Front Proch	thfb	16	210	354	
DE mode Blanking	th-thd	85	256	400	

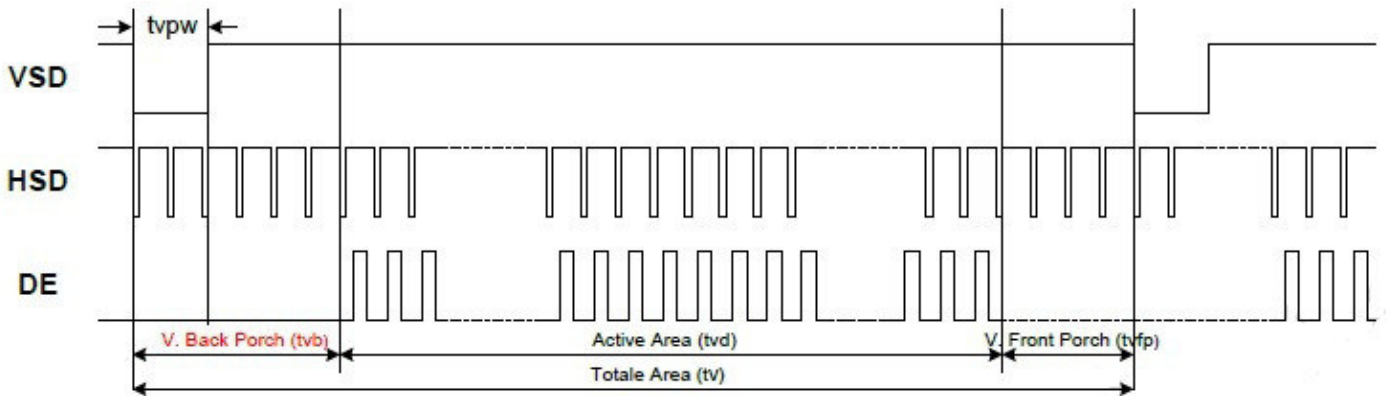
**Vertical input timing**

Parameter	Symbol	Value			Unit
		Min	Typ	Max	
Vertical display area	tvd		480		th
VS period time	tv	513	525	650	th
VS pulse width	tvpw	3	-	20	th
VS ack Porch(Blanking)	tvb		23		th
VS Front Proch	tvfb	7	22	147	th
DE mode Blanking	tv-tvd	30	45	170	th

## 2.3.3 Power On/Off Sequence

To prevent device damage from latch up, the power ON/OFF sequence shown below must be followed.

Power ON: VDD, DGND AVDD, AGND

Power OFF: AVDD, AGND VDD, DGND

Case1: REV = L (Default)

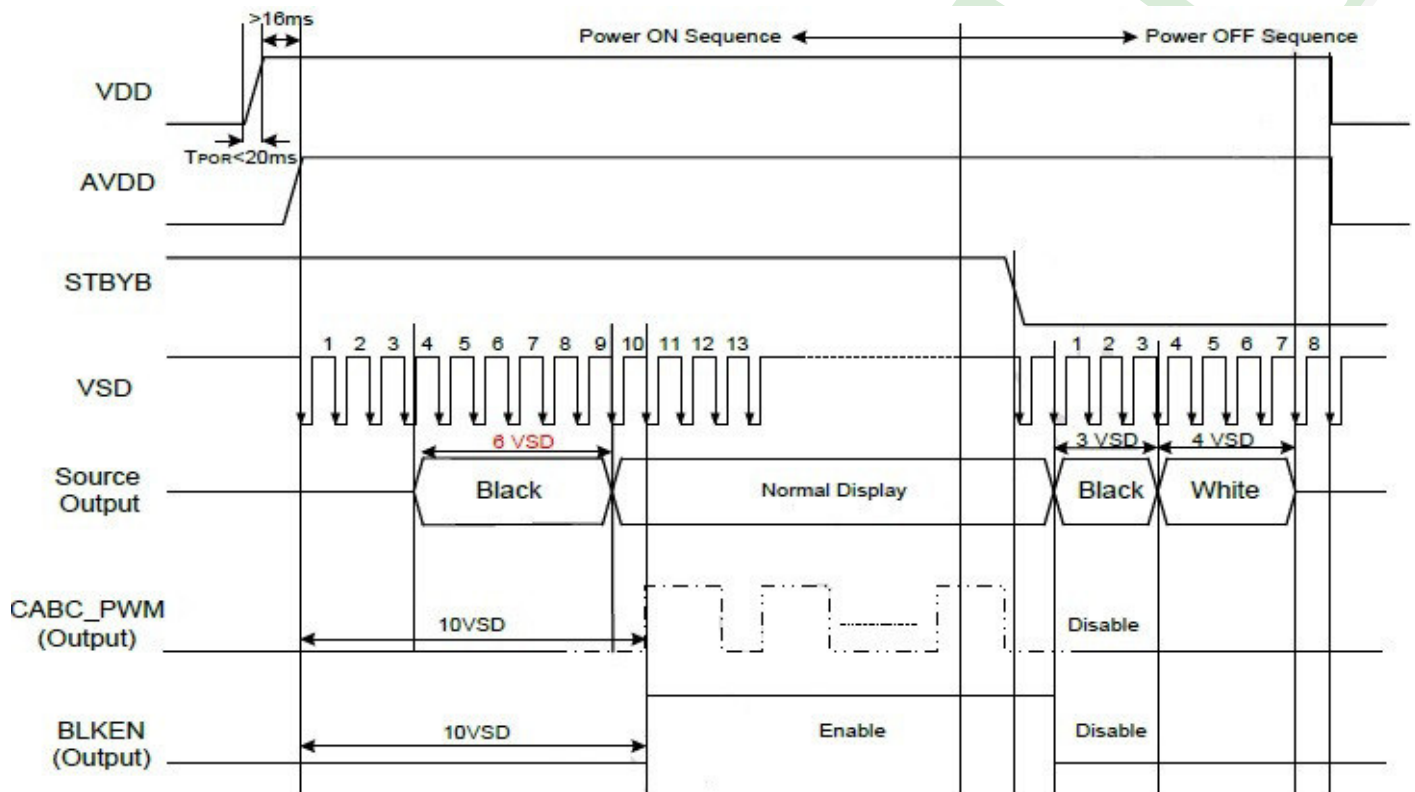

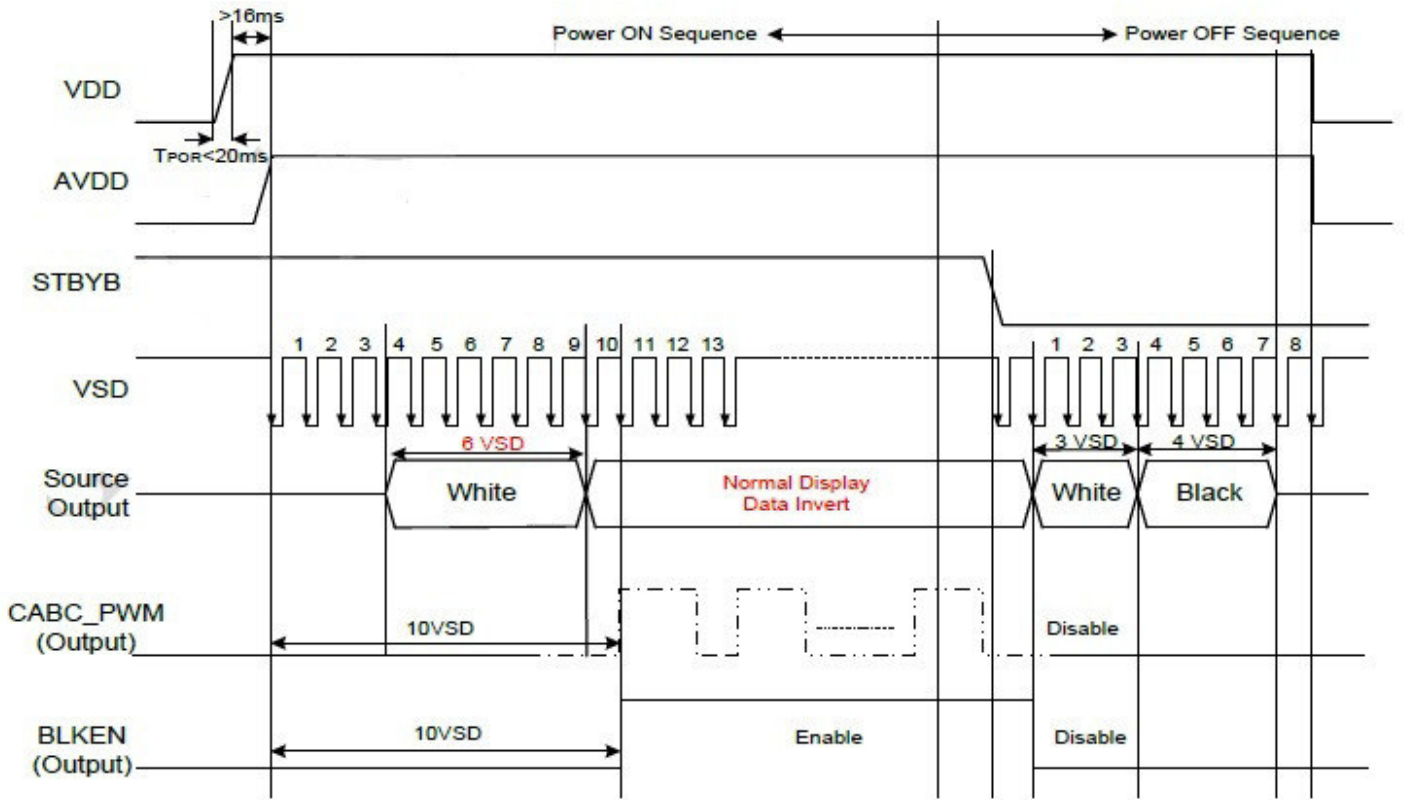
**Case2: REV = H**



### 3. QUALITY ASSURANCE SYSTEM

#### 3.1 Quality Assurance Flow Chart

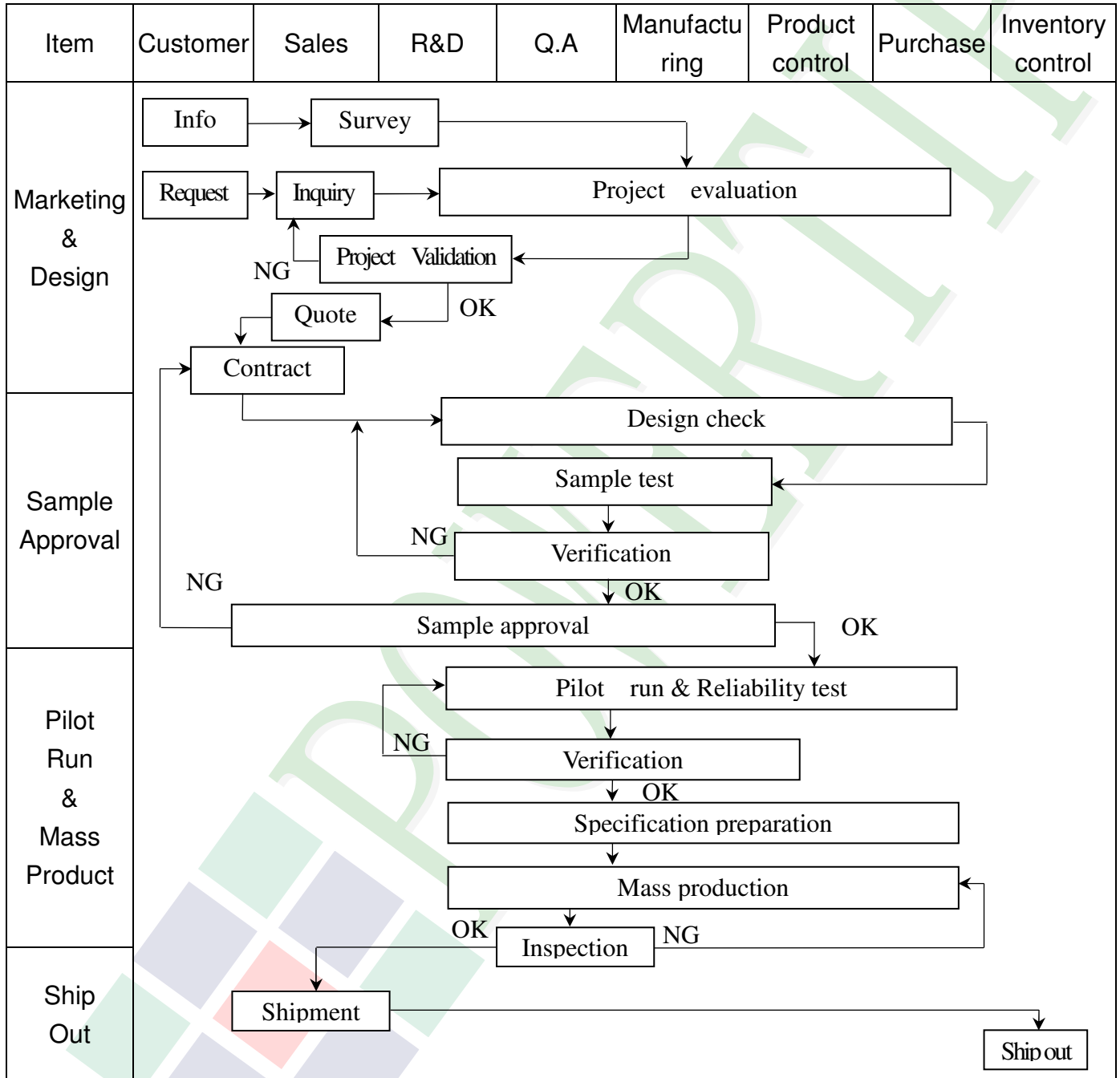

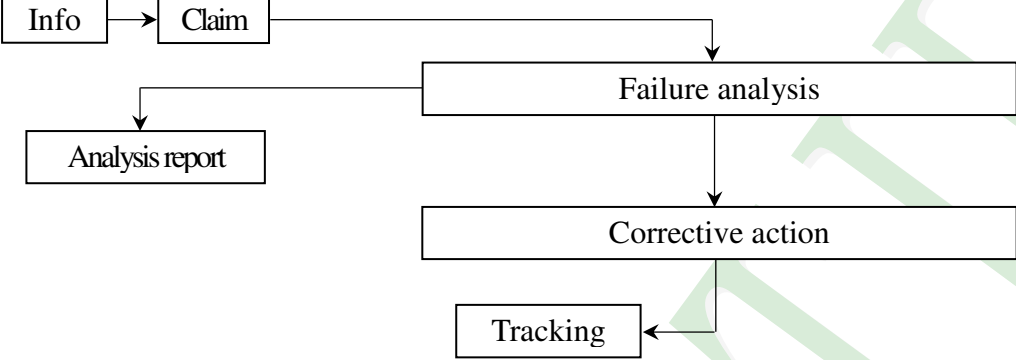
Item	Customer	Sales	R&D	Q.A	Manufacturing	Product control	Purchase	Inventory control
Sales Service	 <pre> graph TD     Info[Info] --&gt; Claim[Claim]     Claim --&gt; Failure[Failure analysis]     Failure --&gt; Report[Analysis report]     Failure --&gt; Action[Corrective action]     Action --&gt; Tracking[Tracking]           </pre>							
Q.A Activity	1. ISO 9001 Maintenance Activities 3. Equipment calibration 5. Standardization Management				2. Process improvement proposal 4. Education And Training Activities			

### 3.2. Inspection Specification

◆Scope : The document shall be applied to TFT-LCD Module for 3.5" ~15" (Ver.B01).

◆Inspection Standard : MIL-STD-105E Table Normal Inspection Single Sampling Level II.

◆Equipment : Gauge 、 MIL-STD 、 Powertip Tester 、 Sample

◆Defect Level : Major Defect AQL : 0.4 ; Minor Defect AQL : 1.5

◆OUT Going Defect Level : Sampling.

◆Standard of the product appearance test :

a. Manner of appearance test :

(1). The test best be under 20W×2 fluorescent light , and distance of view must be at 30 cm.

(2). The test direction is base on about around 45° of vertical line.

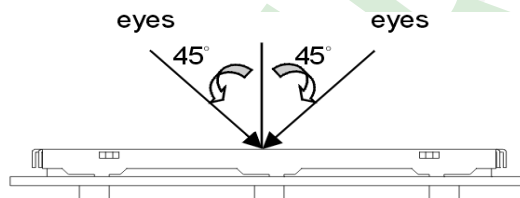

(3). Definition of area.

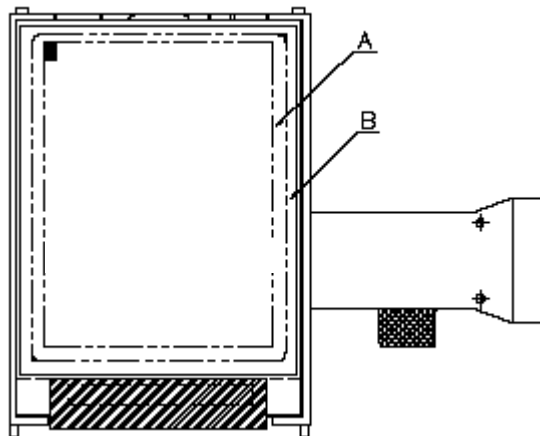

**A** area : viewing area

**B** area : Outside of viewing area

(4). Standard of inspection : (Unit : mm)

**◆Specification For TFT-LCD Module 3.5" ~15" :**

(Ver.B01)

NO	Item	Criterion	Level												
01	Product condition	1. 1 The part number is inconsistent with work order of production.	Major												
		1. 2 Mixed product types.	Major												
		1. 3 Assembled in inverse direction.	Major												
02	Quantity	2. 1 The quantity is inconsistent with work order of production.	Major												
03	Outline dimension	3. 1 Product dimension and structure must conform to structure diagram.	Major												
04	Electrical Testing	4. 1 Missing line character and icon.	Major												
		4. 2 No function or no display.	Major												
		4. 3 Display malfunction.	Major												
		4. 4 LCD viewing angle defect.	Major												
		4. 5 Current consumption exceeds product specifications.	Major												
		4. 6 Mura can not be seen through 5% ND filter, should be judged by the viewing angle of 90 degree.	Minor												
05	Dot defect (Bright dot 、 Dark dot)  On -display	<table border="1"> <thead> <tr> <th></th> <th>Item</th> <th>Acceptance (Q'ty)</th> </tr> </thead> <tbody> <tr> <td rowspan="4">Dot Defect</td> <td>Bright Dot</td> <td><math>\leq 4</math></td> </tr> <tr> <td>Dark Dot</td> <td><math>\leq 5</math></td> </tr> <tr> <td>Joint Dot</td> <td><math>\leq 3</math></td> </tr> <tr> <td>Total</td> <td><math>\leq 7</math></td> </tr> </tbody> </table>		Item	Acceptance (Q'ty)	Dot Defect	Bright Dot	$\leq 4$	Dark Dot	$\leq 5$	Joint Dot	$\leq 3$	Total	$\leq 7$	Minor
			Item	Acceptance (Q'ty)											
Dot Defect	Bright Dot	$\leq 4$													
	Dark Dot	$\leq 5$													
	Joint Dot	$\leq 3$													
	Total	$\leq 7$													
5. 1 Inspection pattern : full white , full black , Red , Green and blue screens. 5. 2 It is defined as dot defect if defect area $> 1/2$ dot. 5. 3 The distance between two dot defect $\geq 5$ mm. 5. 4 Bright dot that can not be seen through 5% ND filter.															

**◆Specification For TFT-LCD Module 3.5" ~15" :**

(Ver.B01)

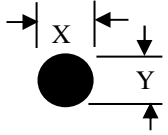
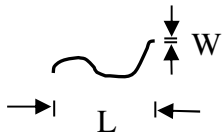
NO	Item	Criterion	Level																																												
06	Black or white dot、scratch、contamination  Round type  $\Phi = (x + y) / 2$  Line type 	<b>6.1 Round type ( Non-display or display ) :</b>  <table border="1"> <thead> <tr> <th rowspan="2">Dimension (diameter : <math>\Phi</math>)</th> <th colspan="2">Acceptance (Q'ty)</th> </tr> <tr> <th>A area</th> <th>B area</th> </tr> </thead> <tbody> <tr> <td><math>\Phi \leq 0.25</math></td> <td colspan="2">Ignore</td> </tr> <tr> <td><math>0.25 &lt; \Phi \leq 0.50</math></td> <td>5</td> <td rowspan="3">Ignore</td> </tr> <tr> <td><math>\Phi &gt; 0.50</math></td> <td>0</td> </tr> <tr> <td><b>Total</b></td> <td>5</td> </tr> </tbody> </table>	Dimension (diameter : $\Phi$ )	Acceptance (Q'ty)		A area	B area	$\Phi \leq 0.25$	Ignore		$0.25 < \Phi \leq 0.50$	5	Ignore	$\Phi > 0.50$	0	<b>Total</b>	5	Minor																													
		Dimension (diameter : $\Phi$ )		Acceptance (Q'ty)																																											
A area	B area																																														
$\Phi \leq 0.25$	Ignore																																														
$0.25 < \Phi \leq 0.50$	5	Ignore																																													
$\Phi > 0.50$	0																																														
<b>Total</b>	5																																														
<b>6.2 Line type( Non-display or display ) :</b>  <table border="1"> <thead> <tr> <th rowspan="2">module size</th> <th rowspan="2">Length (L)</th> <th rowspan="2">Width (W)</th> <th colspan="2">Acceptance (Q'ty)</th> </tr> <tr> <th>A area</th> <th>B area</th> </tr> </thead> <tbody> <tr> <td rowspan="4">3.5" to less 9"</td> <td>---</td> <td><math>W \leq 0.03</math></td> <td colspan="2">Ignore</td> </tr> <tr> <td><math>L \leq 10.0</math></td> <td><math>0.03 &lt; W \leq 0.05</math></td> <td>4</td> <td rowspan="3">Ignore</td> </tr> <tr> <td><math>L \leq 5.0</math></td> <td><math>0.05 &lt; W \leq 0.10</math></td> <td>2</td> </tr> <tr> <td>---</td> <td><math>W &gt; 0.10</math></td> <td colspan="2">As round type</td> </tr> <tr> <td colspan="3"><b>Total</b></td> <td colspan="2">5</td> </tr> <tr> <td rowspan="4">9" to 15"</td> <td>---</td> <td><math>W \leq 0.05</math></td> <td colspan="2">Ignore</td> </tr> <tr> <td><math>L \leq 10.0</math></td> <td><math>0.05 &lt; W \leq 0.10</math></td> <td>5</td> <td rowspan="3">Ignore</td> </tr> <tr> <td>---</td> <td><math>W &gt; 0.10</math></td> <td colspan="2">As round type</td> </tr> <tr> <td colspan="3"><b>Total</b></td> <td colspan="2">5</td> </tr> </tbody> </table>	module size	Length (L)	Width (W)	Acceptance (Q'ty)		A area	B area	3.5" to less 9"	---	$W \leq 0.03$	Ignore		$L \leq 10.0$	$0.03 < W \leq 0.05$	4	Ignore	$L \leq 5.0$	$0.05 < W \leq 0.10$	2	---	$W > 0.10$	As round type		<b>Total</b>			5		9" to 15"	---	$W \leq 0.05$	Ignore		$L \leq 10.0$	$0.05 < W \leq 0.10$	5	Ignore	---	$W > 0.10$	As round type		<b>Total</b>			5		
module size				Length (L)	Width (W)	Acceptance (Q'ty)																																									
	A area	B area																																													
3.5" to less 9"	---	$W \leq 0.03$	Ignore																																												
	$L \leq 10.0$	$0.03 < W \leq 0.05$	4	Ignore																																											
	$L \leq 5.0$	$0.05 < W \leq 0.10$	2																																												
	---	$W > 0.10$	As round type																																												
<b>Total</b>			5																																												
9" to 15"	---	$W \leq 0.05$	Ignore																																												
	$L \leq 10.0$	$0.05 < W \leq 0.10$	5	Ignore																																											
	---	$W > 0.10$	As round type																																												
	<b>Total</b>				5																																										
07	Polarizer Bubble	<table border="1"> <thead> <tr> <th rowspan="2">Dimension (diameter : <math>\Phi</math>)</th> <th colspan="2">Acceptance (Q'ty)</th> </tr> <tr> <th>A area</th> <th>B area</th> </tr> </thead> <tbody> <tr> <td><math>\Phi \leq 0.25</math></td> <td colspan="2">Ignore</td> </tr> <tr> <td><math>0.25 &lt; \Phi \leq 0.50</math></td> <td>4</td> <td rowspan="3">Ignore</td> </tr> <tr> <td><math>0.50 &lt; \Phi \leq 0.80</math></td> <td>1</td> </tr> <tr> <td><math>\Phi &gt; 0.80</math></td> <td>0</td> </tr> <tr> <td><b>Total</b></td> <td>5</td> <td></td> </tr> </tbody> </table>	Dimension (diameter : $\Phi$ )	Acceptance (Q'ty)		A area	B area	$\Phi \leq 0.25$	Ignore		$0.25 < \Phi \leq 0.50$	4	Ignore	$0.50 < \Phi \leq 0.80$	1	$\Phi > 0.80$	0	<b>Total</b>	5		Minor																										
Dimension (diameter : $\Phi$ )	Acceptance (Q'ty)																																														
	A area	B area																																													
$\Phi \leq 0.25$	Ignore																																														
$0.25 < \Phi \leq 0.50$	4	Ignore																																													
$0.50 < \Phi \leq 0.80$	1																																														
$\Phi > 0.80$	0																																														
<b>Total</b>	5																																														

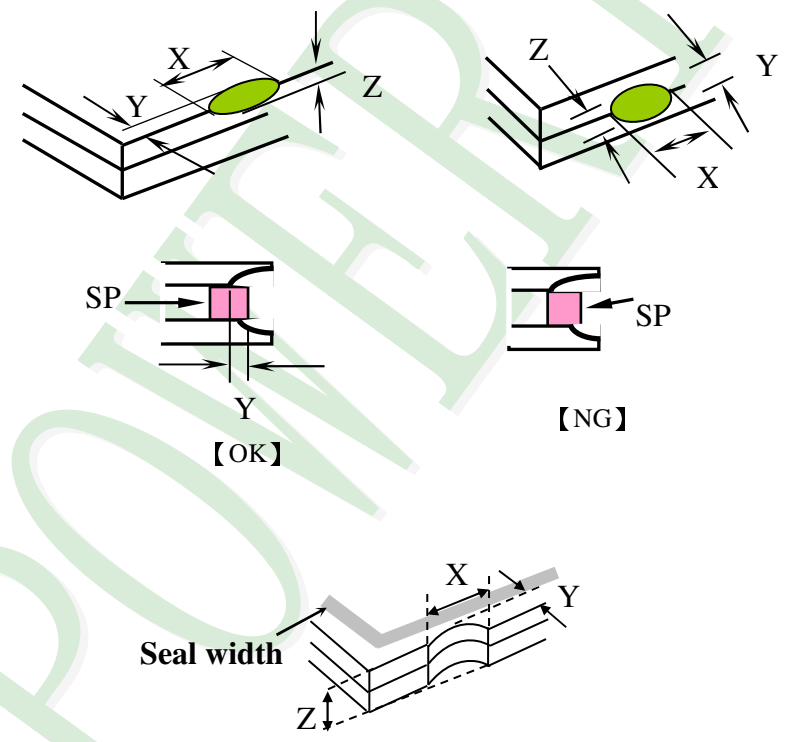

NO	Item	Criterion	Level						
08	The crack of glass	<p><b>Symbols :</b></p> <p><b>X : The length of crack</b>  <b>Z : The thickness of crack</b>  <b>t : The thickness of glass</b></p> <p><b>Y : The width of crack.</b>  <b>W : terminal length</b>  <b>a : LCD side length</b></p> <hr/> <p><b>8.1 General glass chip :</b>  <b>8.1.1 Chip on panel surface and crack between panels:</b></p> 	Minor						
		<table border="1" data-bbox="539 1579 1353 1870"> <thead> <tr> <th>X</th> <th>Y</th> <th>Z</th> </tr> </thead> <tbody> <tr> <td><math>\leq a</math></td> <td>Crack can't enter viewing area</td> <td><math>\leq 1/2 t</math></td> </tr> <tr> <td><math>\leq a</math></td> <td>Crack can't exceed the half of SP width.</td> <td><math>1/2 t &lt; Z \leq 2 t</math></td> </tr> </tbody> </table>		X	Y	Z	$\leq a$	Crack can't enter viewing area	$\leq 1/2 t$
X	Y	Z							
$\leq a$	Crack can't enter viewing area	$\leq 1/2 t$							
$\leq a$	Crack can't exceed the half of SP width.	$1/2 t < Z \leq 2 t$							

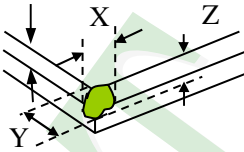
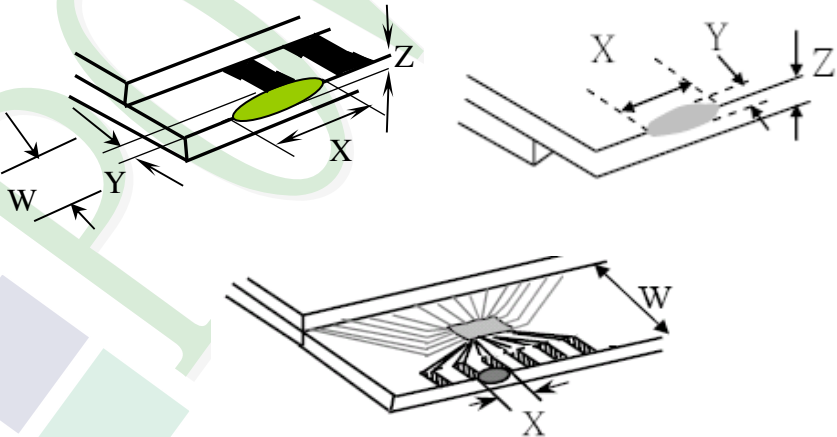
NO	Item	Criterion	Level												
08	The crack of glass	<p><b>Symbols :</b></p> <p><b>X :</b> The length of crack  <b>Z :</b> The thickness of crack  <b>t :</b> The thickness of glass</p> <p><b>Y :</b> The width of crack.  <b>W :</b> terminal length  <b>a :</b> LCD side length</p> <hr/> <p><b>8.1.2 Corner crack :</b></p>  <table border="1" data-bbox="523 768 1337 1059"> <thead> <tr> <th>X</th> <th>Y</th> <th>Z</th> </tr> </thead> <tbody> <tr> <td><math>\leq 1/5 a</math></td> <td>Crack can't enter viewing area</td> <td><math>Z \leq 1/2 t</math></td> </tr> <tr> <td><math>\leq 1/5 a</math></td> <td>Crack can't exceed the half of SP width.</td> <td><math>1/2 t &lt; Z \leq 2 t</math></td> </tr> </tbody> </table>	X	Y	Z	$\leq 1/5 a$	Crack can't enter viewing area	$Z \leq 1/2 t$	$\leq 1/5 a$	Crack can't exceed the half of SP width.	$1/2 t < Z \leq 2 t$				
		X	Y	Z											
$\leq 1/5 a$	Crack can't enter viewing area	$Z \leq 1/2 t$													
$\leq 1/5 a$	Crack can't exceed the half of SP width.	$1/2 t < Z \leq 2 t$													
		<p><b>8.2 Protrusion over terminal :</b></p> <p><b>8.2.1 Chip on electrode pad :</b></p>  <table border="1" data-bbox="560 1697 1345 1872"> <thead> <tr> <th></th> <th>X</th> <th>Y</th> <th>Z</th> </tr> </thead> <tbody> <tr> <td>Front</td> <td><math>\leq a</math></td> <td><math>\leq 1/2 W</math></td> <td><math>\leq t</math></td> </tr> <tr> <td>Back</td> <td><math>\leq a</math></td> <td><math>\leq W</math></td> <td><math>\leq 1/2 t</math></td> </tr> </tbody> </table>		X	Y	Z	Front	$\leq a$	$\leq 1/2 W$	$\leq t$	Back	$\leq a$	$\leq W$	$\leq 1/2 t$	Minor
	X	Y	Z												
Front	$\leq a$	$\leq 1/2 W$	$\leq t$												
Back	$\leq a$	$\leq W$	$\leq 1/2 t$												

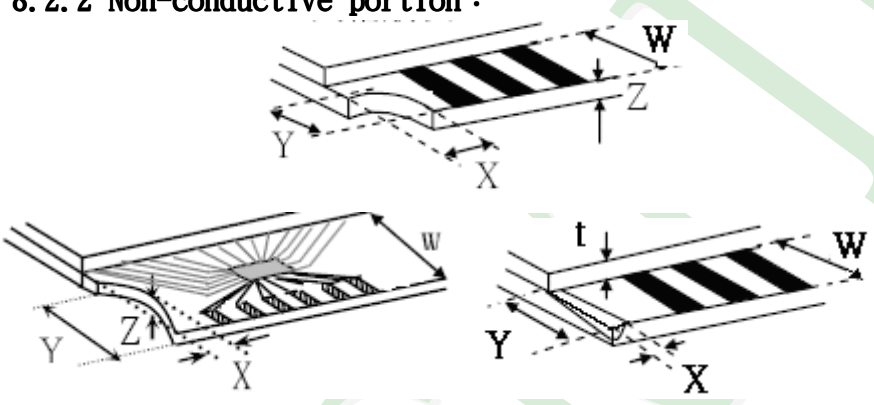
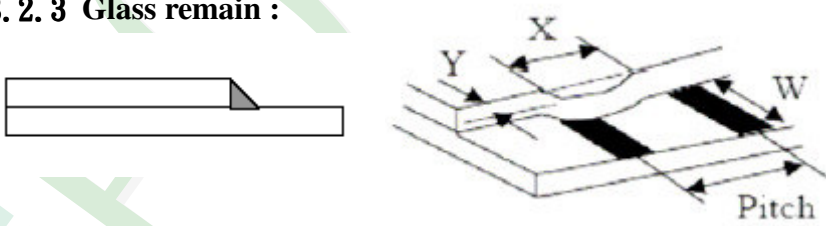
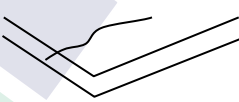
NO	Item	Criterion	Level												
08	The crack of glass	<p><b>Symbols :</b></p> <p><b>X :</b> The length of crack                      <b>Y :</b> The width of crack.  <b>Z :</b> The thickness of crack                  <b>W :</b> terminal length  <b>t :</b> The thickness of glass                   <b>a :</b> LCD side length</p> <hr/> <p><b>8.2.2 Non-conductive portion :</b></p>  <table border="1" data-bbox="625 967 1257 1093"> <thead> <tr> <th>X</th> <th>Y</th> <th>Z</th> </tr> </thead> <tbody> <tr> <td><math>\leq 1/3 a</math></td> <td><math>\leq W</math></td> <td><math>\leq t</math></td> </tr> </tbody> </table> <p>⊙ If the chipped area touches the ITO terminal, over 2/3 of  ● the ITO must remain and be inspected according to electrode terminal specifications.</p> <p><b>8.2.3 Glass remain :</b></p>  <table border="1" data-bbox="545 1523 1241 1648"> <thead> <tr> <th>X</th> <th>Y</th> <th>Z</th> </tr> </thead> <tbody> <tr> <td><math>\leq a</math></td> <td><math>\leq 1/3 W</math></td> <td><math>\leq t</math></td> </tr> </tbody> </table> <p><b>8.2.4 Cracking</b></p>  <p style="text-align: center;"><b>Not Allowed</b></p>	X	Y	Z	$\leq 1/3 a$	$\leq W$	$\leq t$	X	Y	Z	$\leq a$	$\leq 1/3 W$	$\leq t$	Minor
		X	Y	Z											
$\leq 1/3 a$	$\leq W$	$\leq t$													
X	Y	Z													
$\leq a$	$\leq 1/3 W$	$\leq t$													

**◆Specification For TFT-LCD Module 3.5" ~15" :**
**(Ver.B01)**

NO	Item	Criterion	Level
09	Backlight elements	9. 1 Backlight can't work normally.	Major
		9. 2 Backlight doesn't light or color is wrong.	Major
		9. 3 Illumination source flickers when lit.	Major
10	General appearance	10. 1 Pin type 、 quantity 、 dimension must match type in structure diagram.	Major
		10. 2 No short circuits in components on PCB or FPC .	Major
		10. 3 Parts on PCB or FPC must be the same as on the production characteristic chart .There should be no wrong parts , missing parts or excess parts.	Major
		10. 4 Product packaging must the same as specified on packaging specification sheet.	Minor
		10. 5 The folding and peeled off in polarizer are not acceptable.	Minor
		10. 6 The PCB or FPC between B/L assembled distance(PCB or FPC ) is $\leq 1.5$ mm.	Minor





## 5. PRECAUTION RELATING PRODUCT HANDLING

### 5.1 SAFETY

- 5.1.1 If the LCD panel breaks , be careful not to get the liquid crystal to touch your skin.
- 5.1.2 If the liquid crystal touches your skin or clothes , please wash it off immediately by using soap and water.

### 5.2 HANDLING

- 5.2.1 Avoid any strong mechanical shock which can break the glass.
- 5.2.2 Avoid static electricity which can damage the CMOS LSI—When working with the module , be sure to ground your body and any electrical equipment you may be using.
- 5.2.3 Do not remove the panel or frame from the module.
- 5.2.4 The polarizing plate of the display is very fragile. So , please handle it very carefully ,do not touch , push or rub the exposed polarizing with anything harder than an HB pencil lead (glass , tweezers , etc.)
- 5.2.5 Do not wipe the polarizing plate with a dry cloth , as it may easily scratch the surface of plate.
- 5.2.6 Do not touch the display area with bare hands , this will stain the display area.
- 5.2.7 Do not use ketonics solvent & aromatic solvent. Use with a soft cloth soaked with a cleaning naphtha solvent.
- 5.2.8 To control temperature and time of soldering is  $320\pm 10^{\circ}\text{C}$  and 3-5 sec.
- 5.2.9 To avoid liquid (include organic solvent) stained on LCM .

### 5.3 STORAGE

- 5.3.1 Store the panel or module in a dark place where the temperature is  $25^{\circ}\text{C} \pm 5^{\circ}\text{C}$  and the humidity is below 65% RH.
- 5.3.2 Do not place the module near organics solvents or corrosive gases.
- 5.3.3 Do not crush , shake , or jolt the module.

### 5.4 TERMS OF WARRANTY

- 5.4.1 Applicable warrant period  
The period is within thirteen months since the date of shipping out under normal using and storage conditions.
- 5.4.2 Unaccepted responsibility  
This product has been manufactured to your company's specification as a part for use in your company's general electronic products. It is guaranteed to perform according to delivery specifications. For any other use apart from general electronic equipment , we cannot take responsibility if the product is used in nuclear power control equipment , aerospace equipment , fire and security systems or any other applications in which there is a direct risk to human life and where extremely high levels of reliability are required.



# LCM包裝規格書

## LCM Packaging Specifications

Approve	Check	Contact
Jimmy	Tina	Clare

### 1. 包裝材料規格表 (Packaging Material) : (per carton)

No.	Item	Model	Dimensions (mm)	1Pcs Weight	Quantity	Total Weight
1	成品 (LCM)	PH800480T028-ZFA	105.5 X 67.2 X 2.6	0.038	160	6.08
2	氣泡袋(1)Bubble Bag	BAG0000000005	150 X 120	0.002	160	0.32
3	A2隔板(2)A2Partition	BX29300070BMBA	293 X 70 X 2.5	0.0109	88	0.9592
4	B2隔板(3)B2Partition	BX24500070BLBA	245 X 70 X 2.5	0.0094	24	0.2256
5	氣泡紙(4)Bubble Sheet	BAG280240BWABA	280 X 240	0.006	16	0.096
6	C2內盒(5)Product Box	BX31025580AABA	310 X 255 X 86	0.16	8	1.28
7	外紙箱(6)Carton	BX52732536CCBA	527 X 325 X 360	0.83	1	0.83
8						
9						

2. 一 整箱總重量 (Total LCD Weight in carton) : 9.79 Kg±10%

3. 單箱數量規格表 (Packaging Specifications and Quantity) :

(1)Quantity Of Spacer : A2隔板 X 11 , B2隔板 X 3  
 (2)Total LCM quantity in carton : quantity per box 20 x no of boxes 8 = 160

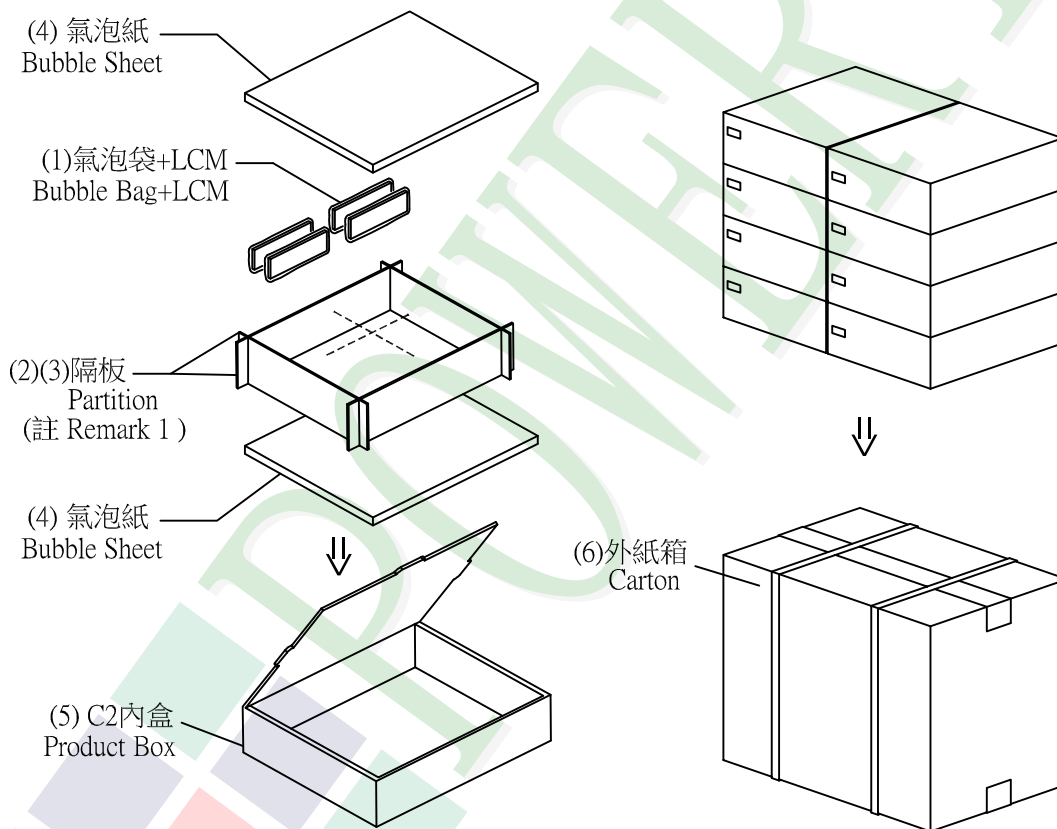

### 特 記 事 項 (REMARK)

1. LCM排放示意圖(前後間隔不放置):  
 1. LCM placed as figure showing:  
 ( First and last slot should be empty)

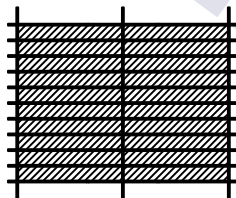

▨ 模組(LCM) X 1pcs.



ALL TECHNOLOGIES. ALL COMPETENCIES. ONE  
SPECIALIST.

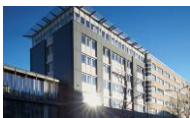

DATA MODUL AG  
Landsberger Straße 322  
DE-80687 Munich  
Phone: +49-89-56017-0

DATA MODUL WEIKERSHEIM GMBH  
Lindenstraße 8  
DE-97990 Weikersheim  
Phone: +49-7934-101-0



More information and worldwide locations can  
be found at

[www.data-modul.com](http://www.data-modul.com)