

DMC Co., Ltd.

**Analog Resistive Touchscreen
QST Series Product Specifications**

Table of Contents

1. Product Specifications..... 3

1-1. Product Applicable..... 3

1-2. Structure 3

1-3. Feature 3

1-4. Environmental Specifications..... 3

1-5. Mechanical Characteristics 3

1-6. Electrical Characteristics..... 3

1-7. Appearance..... 4

2. Testing Regulation 5

2-1. Testing Regulation 5

2-2. Environmental Specifications..... 5

2-3. Mechanical Characteristics 5

2-4. Electrical Characteristics..... 6

2-5. Appearance..... 6

3. Reliability Condition..... 7

3-1. Temperature Condition..... 7

4. Recommended Connector 7

4-1. Recommended Connector 7

5. Handling Notes..... 8

5-1. Precautions 8

5-2. Handling Notes..... 8

5-3. Construction Notes 8

5-4. Electrical & Software Notice 8

5-5. Mounting Notes 9

6. Warranty..... 11

6-1. Warranty Period..... 11

6-2. Warranty Target 11

6-3. Warranty Exceptions..... 11

6-4. Tools 11

6-5. Changes 11

6-6. RoHS Compliance 11

7. Revision History..... 12

1. Product Specifications

1-1. Product Applicable

§ This specification is applied to the analog resistive touchscreen: QST Series.

1-2. Structure

§ Dimensions, structure, and shape are referred on the drawing attached.

1-3. Feature

§ No Air vent structure, less visible spacer dots, polyimide tail

1-4. Environmental Specifications

Specification	Value
Operating Temperature	-20°C to 70°C (no condensation)
Operating Humidity	-20°C to 60°C Less than 90%RH (no condensation) Exceeding 60°C 133.8g/m ³ (no condensation)
Storage Temperature	-40°C to 80°C (no condensation)
Storage Humidity	-40°C to 60°C Less than 95%RH (no condensation) Exceeding 60°C 142.9g/m ³ (no condensation)
Chemical Resistance (top surface)	Toluene, Trichloroethylene, Athetone, Alcohol, Gasoline, Machine Oil, Ammonia, Glass Cleaner, Mayonnaise, Ketchup, Wine, Salad Oil, Vinegar, Lipstick, etc.

1-5. Mechanical Characteristics

Specification	Value
Activation Force	0.05N to 0.8N
Operating Life	Input (finger) 10,000,000 hits
	Character Input (pen) 100,000 characters
Light Transmittance	Over 80% (typical value at full wavelength)
Surface Hardness	Over 2H (by JIS pencil hardness)

1-6. Electrical Characteristics

Specification	Value
Maximum Voltage	DC6V
Maximum Current	Top Electrode 100mA
	Bottom Electrode 100mA
	Between the Top and Bottom 0.5mA
Linearity	Under ±2% (Under ±1% (typical value))
Terminal Resistance	Top Electrode Less than 1kΩ
	Bottom Electrode Less than 1kΩ
Insulation Resistance	Neighboring Terminals Over 20MΩ at 25V
	Active Area Electrodes Over 20MΩ at 25V
Chattering	Less than 10msec at ON/OFF.

1-7. Appearance

§ Scratch, dust (W = width, L = length, D = average diameter = (longest + shortest) /2)

Item	Width (mm)	Length (mm)	Acceptable Numbers	Total
Linear(Scratch/Dust) Over 0.1mm in diameter refer to the Circular.	$0.1 \geq W > 0.05$	$4 \geq L$	1pcs in $\phi 30\text{mm}$	Within 5pcs /panel
	$0.05 \geq W > 0.03$	$10 \geq L$	2pcs in $\phi 20\text{mm}$	
	$0.03 \geq W$	$20 \geq L$	Acceptable	
Circular (Scratch/Dust)	$0.4 \geq D > 0.3$ *1		1pcs in viewing area *1	
	$0.3 \geq D > 0.2$		2pcs in $\phi 30\text{mm}$	
	$0.2 \geq D$		Acceptable	

Applied only in the Viewing Area. Scratches or dusts in the outside of the Viewing Area are acceptable unless the electrical characteristics are affected.

*1 Applied to the size of 14 inches or more.

§ Dirt

Acceptable if not noticeable on a black mat.

§ Chip, crack (t = glass thickness) (applicable only for the glass)

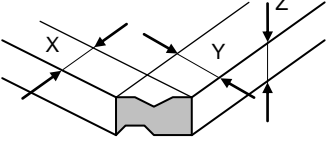
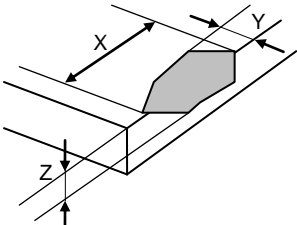
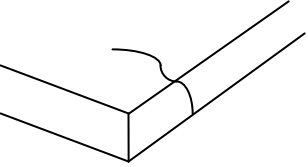
Item	Size (mm)		Acceptable Numbers
Corner 	X	≤ 3	2pcs /panel
	Y	≤ 3	
	Z	$\leq t$	
Side 	X	≤ 5	2pcs /side
	Y	≤ 3	
	Z	$\leq t$	
Crack 			Not acceptable

2. Testing Regulation

2-1. Testing Regulation

§ If the regulation is not specified, the test is performed under the supplier's regulation.

§ Tests are performed under the room temperature unless specified. The room temperature is referred as follows:

Temperature: 20°C±5°C
Humidity: 65%±10%RH

2-2. Environmental Specifications

§ Chemical Resistance Test

Condition: Tested after leaving the chemical on the surface for 12 hours being wiped off by cloth.

Judgement: Must be no effect in appearance.

2-3. Mechanical Characteristics

§ Activation Force Test

Condition: Measured by depressing the point between the dots to the conduction by the testing rod (Figure 1).

Judgement: Must satisfy the specification.

§ Operating Life Test (Finger)

Condition: Testing rod: Refer to Figure 1
Voltage: DC5V
Load: 3N
Cycle: 2 hits/sec

Judgement: Must satisfy the following:

Activation Force:	Must satisfy the specification.
Linearity:	Must satisfy the specification.
Terminal Resistance:	Must satisfy the specification.
Insulation Resistance:	Must satisfy the specification.

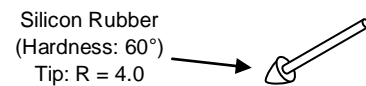

Figure 1. Testing rod 1

§ Operating Life Test (Pen)

Condition: Testing rod: Refer to Figure 2
Voltage: DC5V
Load: 2.5N
Input size: 10 x 10 mm
Input character: A to Z/minute

Judgement: Must satisfy the following:

Activation Force:	Must satisfy the specification.
Linearity:	Must satisfy the specification.
Terminal Resistance:	Must satisfy the specification.
Insulation Resistance:	Must satisfy the specification.

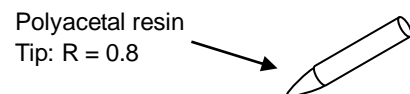

Figure 2. Testing rod 2

2-4. Electrical Characteristics

§ Terminal Resistance Test

Condition: Top and bottom electrodes are measured at the terminal.

Judgement: Must satisfy the specification.

§ Insulation Resistance Test

Neighboring Terminals: Measured by applying the reference voltage to the terminals

Active Area Electrodes: Measured by applying the reference voltage to the top and bottom electrodes.

Judgement: Must satisfy the specification.

2-5. Appearance

§ Appearance Test

Condition: Tested by an examiner with over 1.0 eyesight at 30cm away from the product under the transmittable light at over 60° the surface of the product.

Judgement: Must satisfy the specification.

3. Reliability Condition

3-1. Temperature Condition

§ Temperature Condition Test

Following tests are performed in the condition with no dew condensation:

Cold Test: Tested after leaving the parts in $-40^{\circ}\text{C}\pm 3^{\circ}\text{C}$ for 240 hours and in the room temperature for 2 hours.

Heat Test: Tested after leaving the parts in $80^{\circ}\text{C}\pm 3^{\circ}\text{C}$ for 240 hours and in the room temperature for 2 hours.

Humidity Test: Tested after leaving the parts in the temperature $60^{\circ}\text{C}\pm 3^{\circ}\text{C}$, humidity 90 to 95% for 240 hours and in the room temperature for 2 hours.

Cycle Test: Tested after 5 cycles of leaving the parts in the temperature $-30^{\circ}\text{C}\pm 3^{\circ}\text{C}$ for 1 hour and in the room temperature for 0.5 hours, then leaving the parts in the temperature $70^{\circ}\text{C}\pm 3^{\circ}\text{C}$ for 1 hour and in the room temperature for 0.5 hours.

Judgement: Must satisfy the following:

Activation Force: Must satisfy the specification.

Linearity: Must satisfy the specification.

Terminal Resistance: Must satisfy the specification.

Insulation Resistance: Must satisfy the specification.

Appearance: Must satisfy the specification.

4. Recommended Connector

4-1. Recommended Connector

Part No.	Manufacturer	Pins	Pitch
04FMS-1.0SP-GB-TF(LF)(SN)	JST Mfg. Co., Ltd	4 pins (Double-sided)	1.00mm

Or any other connector whose specifications are same as above.

5. Handling Notes

5-1. Precautions

§ This product is intended for use in standard applications (computers, office automation, and other office equipment, industrial, communications, and measurement equipment, personal and household devices, etc.) Please avoid using this product for special applications where failure or abnormal operation may directly affect human lives, or cause physical injury or property damage, or where extremely high levels of reliability are required (such as aerospace systems, vehicle operating control, atomic energy controls, medical devices for life support, etc.).

5-2. Handling Notes

- § Do not depress or scratch the product with any object with a sharp edge or hard end.
- § Do not put this product close to fire.
- § Do not wipe this product with too much load.
- § Do not strongly rub this product locally. It may affect the product's functions.
- § Do not hit the product with a hard object.
- § Do not forcibly bend or fold the product.
- § When the product is stored, make sure it is packed in a packing box and stored in a storage temperature range, eliminating any outside load.
- § Do not use or store the product under a condition where the product will be exposed to water, organic solution or acid.
- § Do not use the product under the direct sunlight.
- § Do not disassemble the product.
- § When you handle the product, Hold the product by its body. Do not hold by the tail.
- § Clean the product with a soft cloth or a soft cloth with neutral detergent or alcohol. When contaminated by chemicals, wipe them off immediately with caution not to cause injury to human body.
- § The edge of the glass is not rounded and may cause injury.

5-3. Construction Notes

- § The environmental specifications, mechanical characteristics, and electrical characteristics are only applied to the Active Area.
- § Do not use the touchscreen when the condensation occurs. The condensation inside of the touchscreen is a natural phenomenon and should disappear after the touchscreen is warmed up.

5-4. Electrical & Software Notice

The best performance can be obtained when used with the original analog resistive touchscreen controller, TSC Series. If the touchscreen controller or controller software is to be developed by the customer, please note the following:

- § There is a contact resistance between the top and bottom electrodes and it changes by the pressure of a finger or a pen. The data must be read after the contact resistance becomes stabilized.
- § The terminal resistance of the analog resistive touchscreen varies by the individual, time, and environment. The controller software must have the calibration function to adjust the input position and the display position.
- § The analog resistive touchscreen outputs 2 point input as 1 point in between the 2 points. The controller software must not be designed to have the 2 point input function.
- § For drawing applications, the line may be intermittent when the pen comes on the dot spacers. A software compensation is needed.

5-5. Mounting Notes

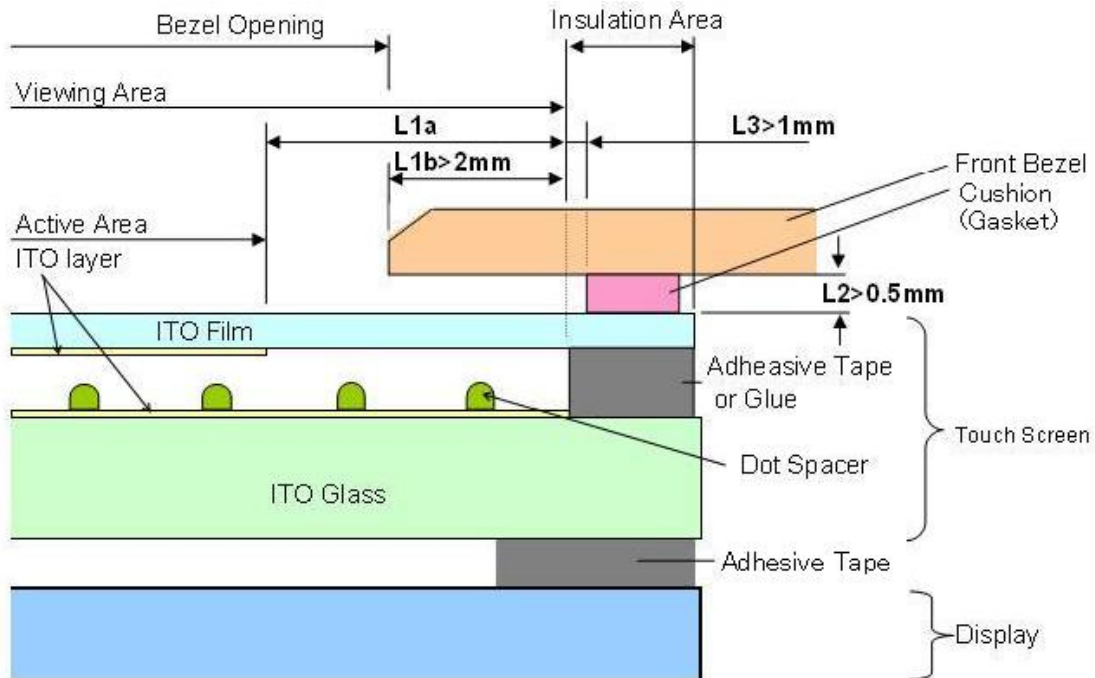
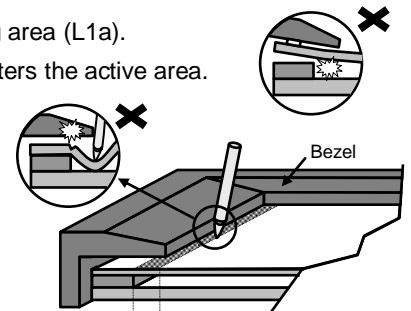

Fig.1

§ Bezel Edge

Bezel edge must be positioned in the area between the active area and viewing area (L1a). Otherwise the bezel may press the touch screen and cause input if the edge enters the active area. The area within 2mm (L1b) from the insulation area is structurally weak for the pressure, especially for pen use. The film may be forcibly bent and may cause deflection. This area must be protected by the bezel and input must be avoided.



§ Gap between the Bezel and Touchscreen

A gap of approximately 0.5mm (L2) is needed between the bezel and the touch screen surface. It may cause unexpected input if the gap is too narrow

§ Cushion (Gasket)

If a cushion is used between the bezel and the touch screen surface, the cushion must be free enough to absorb the expansion and contraction difference between the bezel and the touch screen surface. If the cushion is squashed to hard, the expansion and contraction difference may cause the distortion to the touch screen surface. The cushion must be positioned more than 1mm (L3) outward from an inside of the insulation area. (Please see the above structure Fig.1)

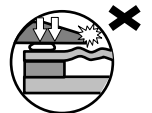

In case water-proof structure is necessary, use rubber materials as a cushion in a window frame form.

§ Mounting Touchscreen

Touchscreen must be held from the bottom such as the structure gluing the touchscreen onto the display. If the touchscreen is glued to the bezel, the adhesion between the top and bottom electrode is stressed and may come off.

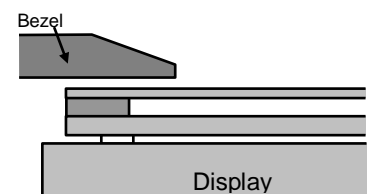

§ Tail

The tail must not be forcibly stressed or bent too hard to avoid the conduction in the insulated area and wire breaking.

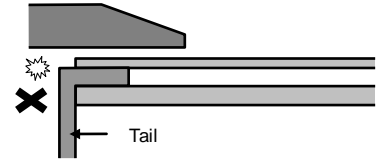
**§ Tolerance**

There is a tolerance of 0.2 to 0.3mm for the dimensions of the touchscreen and the tail. A gap must be made to absorb the tolerance in the case and the connector.

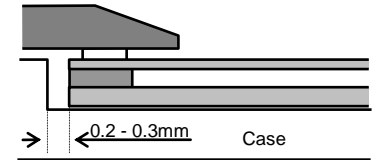

6. Warranty

6-1. Warranty Period

- § The warranty period is limited to 1 year from the date of shipping. The warranty for the initial deflection such as appearance deflection is limited to 1 month.
- § Any defected parts under proper use will be examined by the supplier and replaced by the new parts if the deflection is considered to be caused by the supplier.
- § The replacement is subject to be included in the next lot.

6-2. Warranty Target

- § The warranty only covers the product itself and does not cover any damage to others caused by using this product. Onsite repair or replacement is not supported.
- § We will do our best for delivery problem and product deflections, but the warranty for the production line is not covered.
- § Resistive touchscreens are structurally not repairable. All deflections are subject to replacement.

6-3. Warranty Exceptions

Following conditions are not covered with the warranty and subject to charge.

- § Any malfunctions and damages during transportation and transfer by the user.
- § Any malfunctions and damages caused by a natural disaster or a fire.
- § Any malfunctions and damages caused by static electricity
- § Any malfunctions and damages caused by the failure of the associated equipment.
- § If the product is remodeled, disassembled or repaired by the user.
- § If the product is glued onto the equipment and uninstalled.
- § Any malfunctions and damages caused by an improper usage and handling against the specifications and notes.

6-4. Tools

- § All the tools, such as CAD data (except for the drawing for approval), block copies (films), printing screens, and die-cut plates are not to be provided for administrative purpose.

6-5. Changes

- § Because of the manufacturing process, changing the dimensions, circuit pattern, and the tail position requires replacing most of the tools and is subject to high tooling charge. Please be careful when ordering and approving the drawing.
- § Circuit pattern and the materials that does not affect the environmental, electrical, and mechanical characteristics such as film, glass, ink and glue are subject to change for the supplier's reason or for improvement within the specifications.
- § Standard products are subject to change for improvement without notice.

6-6. RoHS Compliance

- § This product complies with RoHS

7. Revision History

Rev1 (Apr. 25, 2010)

Initial release

Rev2 (Aug.25, 2011)

6-4. Tools: The below description has been deleted.

“To maintain the quality, the printing screens and the die-cut plates are generally limited to use up to 1 year. Reorders after 1 year from the initial order or from the last renewal are subject to the tooling charge for replacing the printing screens and the die-cut plates. Reorders for the discontinued standard parts are also subject to tooling charge.”

6-6. RoHS Compliance: Description about RoHS compliance has been added.

1.3. Feature has been added.

Rev2.1 (May 24, 2012)

Address has changed as Tokyo office had moved.

Rev3 (Feb 13, 2013)

1-6. Appearance

Tip → Chip (Scribal error corrected)

5-2. Handling Notes

- Do not depress or scratch the product with any object with a sharp edge or end. → Do not depress or scratch the product with any object with a sharp edge or hard end. (Description changed)
- Do not put this product close to fire. (Description added)
- Do not wipe this product with too much load. (Description added)
- Do not strongly rub this product locally. It may affect the product' s functions. (Description added)
- Do not hit the product with a hard object. (Description added)

© 2013 DMC Co., Ltd.

This document can be freely distributed, but any alternation to this document is prohibited.

DMC Co., Ltd.

<http://www.dmccoltd.com/english/>

11F Nisseki Takanawa Bldg., 2-18-10 Takanawa, Minato-ku, Tokyo 108-0074, Japan

Phone: +81-3-6721-6731 (Japanese), 6736 (English) Fax: +81-3-6721-6732