

# SMARC<sup>®</sup> conga-SMC1

Detailed description of the congatec SMARC 3.5 “ application carrier board

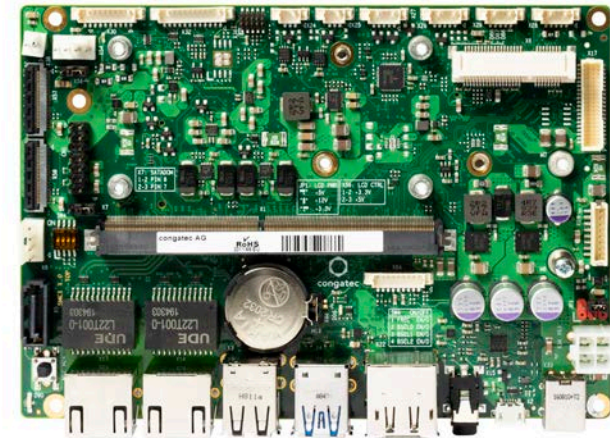

***User's Guide***

Revision 1.2

# Revision History

---

Revision	Date (yyyy-mm-dd)	Author	Changes
0.1	2020-08-28	AEM	<ul style="list-style-type: none"><li>• Preliminary release</li></ul>
1.0	2020-09-16	AEM	<ul style="list-style-type: none"><li>• Added section 4.17 "Test Mode/Wireless-Disable Mode"</li><li>• Official release</li></ul>
1.1	2021-07-31	AEM	<ul style="list-style-type: none"><li>• Added License Information for x86 and ARM products</li><li>• Changed congatec AG to congatec GmbH</li></ul>
1.2	2021-11-08	AEM	<ul style="list-style-type: none"><li>• Changed SMARC specification, revision 2.0 to revision 2.1 in table 4 "Feature Summary"</li></ul>

---

# Preface

---

This user's guide provides information about the components, features and connectors available on the congatec SMARC 3.5 " carrier board.

## Software Licenses (congatec x86 Products)

### Notice regarding Open Source software

The congatec products contains Open Source software that has been released by programmers under specific licensing requirements such as the "General Public License" (GPL) Version 2 or 3, the "Lesser General Public License" (LGPL), the "ApacheLicense" or similar licenses.

You can find the specific details at <https://www.congatec.com/en/licenses/>. Search for the revision of the BIOS/UEFI or Board Controller Software (as shown in the POST screen or BIOS setup) to get the complete product related license information. To the extent that any accompanying material such as instruction manuals, handbooks etc. contain copyright notices, conditions of use or licensing requirements that contradict any applicable Open Source license, these conditions are inapplicable.

The use and distribution of any Open Source software contained in the product is exclusively governed by the respective Open Source license. The Open Source software is provided by its programmers without ANY WARRANTY, whether implied or expressed, of any fitness for a particular purpose, and the programmers DECLINE ALL LIABILITY for damages, direct or indirect, that result from the use of this software.

### OEM/ CGUTL BIOS

BIOS/UEFI modified by customer via the congatec System Utility (CGUTL) is subject to the same license as the BIOS/UEFI it is based on. You can find the specific details at <https://www.congatec.com/en/licenses/>.

## Software Licenses (congatec ARM Products)

### Notice regarding Open Source software

This product contains Open Source software that has been released by programmers under specific licensing requirements such as the "General Public License" (GPL) Version 2 or 3, the "Lesser General Public License" (LGPL), the "ApacheLicense" or similar licenses. You can find the specific details at <https://www.congatec.com/en/licenses/>.

Enter the following command "license" in the bootloader to get the complete product related license information. To the extent that any accompanying material such as instruction manuals, handbooks etc. contain copyright notices, conditions of use or licensing requirements that contradict any applicable Open Source license, these conditions are inapplicable. The use and distribution of any Open Source software contained in the product is exclusively governed by the respective Open Source license.

---

The Open Source software is provided by its programmers without ANY WARRANTY, whether implied or expressed, of any fitness for a particular purpose, and the programmers DECLINE ALL LIABILITY for damages, direct or indirect, that result from the use of this software.

congatec's liability with regards to the open source Software is as set out in congatec's Software License Information.

## Disclaimer

The information contained within this user's guide, including but not limited to any product specification, is subject to change without notice.

congatec AG provides no warranty with regard to this user's guide or any other information contained herein and hereby expressly disclaims any implied warranties of merchantability or fitness for any particular purpose with regard to any of the foregoing. congatec AG assumes no liability for any damages incurred directly or indirectly from any technical or typographical errors or omissions contained herein or for discrepancies between the product and the user's guide. In no event shall congatec AG be liable for any incidental, consequential, special, or exemplary damages, whether based on tort, contract or otherwise, arising out of or in connection with this user's guide or any other information contained herein or the use thereof..

## Intended Audience

This user's guide is intended for technically qualified personnel. It is not intended for general audiences.

## Lead-Free Designs (RoHS)

All congatec AG designs are created from lead-free components and are completely RoHS compliant.

## Electrostatic Sensitive Device



All congatec AG products are electrostatic sensitive devices. They are enclosed in static shielding bags, and shipped enclosed in secondary packaging (protective packaging). The secondary packaging does not provide electrostatic protection.

Do not remove the device from the static shielding bag or handle it, except at an electrostatic-free workstation. Also, do not ship or store electronic devices near strong electrostatic, electromagnetic, magnetic, or radioactive fields unless the device is contained within its original packaging. Be aware that failure to comply with these guidelines will void the congatec AG Limited Warranty

---

## Symbols

The following symbols are used in this user's guide:



### Warning

*Warnings indicate conditions that, if not observed, can cause personal injury.*



### Caution

*Cautions warn the user about how to prevent damage to hardware or loss of data.*



### Note

*Notes call attention to important information that should be observed.*



### Connector Type

*Describes the connector that should be used with the congatec SMARC™ 3.5 " carrier board.*



### Link to connector layout diagram

*This link icon is located in the top left corner of each page. It provides a direct link to the connector layout diagram on page 12 of this document.*

## Copyright Notice

Copyright © 2020, congatec AG. All rights reserved. All text, pictures and graphics are protected by copyrights. No copying is permitted without written permission from congatec AG.

congatec AG has made every attempt to ensure that the information in this document is accurate yet the information contained within is supplied "as-is".

---

## Trademarks

Product names, logos, brands, and other trademarks featured or referred to within this user's guide, or the congatec website, are the property of their respective trademark holders. These trademark holders are not affiliated with congatec AG, our products, or our website.

## Warranty

congatec AG makes no representation, warranty or guaranty, express or implied regarding the products except its standard form of limited warranty ("Limited Warranty") per the terms and conditions of the congatec entity, which the product is delivered from. These terms and conditions can be downloaded from [www.congatec.com](http://www.congatec.com). congatec AG may in its sole discretion modify its Limited Warranty at any time and from time to time.

The products may include software. Use of the software is subject to the terms and conditions set out in the respective owner's license agreements, which are available at [www.congatec.com](http://www.congatec.com) and/or upon request.

Beginning on the date of shipment to its direct customer and continuing for the published warranty period, congatec AG represents that the products are new and warrants that each product failing to function properly under normal use, due to a defect in materials or workmanship or due to non conformance to the agreed upon specifications, will be repaired or exchanged, at congatec's option and expense.

Customer will obtain a Return Material Authorization ("RMA") number from congatec AG prior to returning the non conforming product freight prepaid. congatec AG will pay for transporting the repaired or exchanged product to the customer.

Repaired, replaced or exchanged product will be warranted for the repair warranty period in effect as of the date the repaired, exchanged or replaced product is shipped by congatec, or the remainder of the original warranty, whichever is longer. This Limited Warranty extends to congatec's direct customer only and is not assignable or transferable.

Except as set forth in writing in the Limited Warranty, congatec makes no performance representations, warranties, or guarantees, either express or implied, oral or written, with respect to the products, including without limitation any implied warranty (a) of merchantability, (b) of fitness for a particular purpose, or (c) arising from course of performance, course of dealing, or usage of trade.

congatec AG shall in no event be liable to the end user for collateral or consequential damages of any kind. congatec shall not otherwise be liable for loss, damage or expense directly or indirectly arising from the use of the product or from any other cause. The sole and exclusive remedy against congatec, whether a claim sound in contract, warranty, tort or any other legal theory, shall be repair or replacement of the product only.

## Certification



congatec AG is certified to DIN EN ISO 9001 standard.



## Technical Support

congatec AG technicians and engineers are committed to providing the best possible technical support for our customers so that our products can be easily used and implemented. We request that you first visit our website at [www.congatec.com](http://www.congatec.com) for the latest documentation, utilities and drivers, which have been made available to assist you. If you still require assistance after visiting our website then contact our technical support department by email at [support@congatec.com](mailto:support@congatec.com)

## Terminology

Term	Description
ARM	Advanced RISC Machines
CAN	Controller Area Network
cBC	congatec Board Controller
CSI	Camera Serial Interface
DP	DisplayPort
eDP	Embedded DisplayPort
eSPI	Enhanced Serial Peripheral Interface
GbE	Gigabit Ethernet
GHz	Gigahertz
GPIO	General Purpose Input Output
HDA	High Definition Audio
I <sup>2</sup> C Bus	Inter-Integrated Circuit Bus
kB	Kilobyte
kHz	Kilohertz
LVDS	Low Voltage Differential Signalling
MB	Megabyte
Mbit	Megabit
MHz	Megahertz
N.A	Not available
N.C	Not connected
OTG	On-The-Go
PCH	Platform Controller Hub
PCIe	PCI Express
SATA	Serial ATA
SDIO	Secure Digital Input Output
SM Bus	System Management Bus
SPI	Serial Peripheral Interface
USB	Universal Serial Bus

# Contents

1	Introduction .....	10	4.6	MIPI-CSI Connectors.....	32
1.1	SMARC™ Concept .....	10	4.6.1	CSI0 Interface.....	32
1.2	conga-SMC1 .....	10	4.6.2	CSI1 Interface.....	33
1.2.1	Order Number .....	10	4.7	USB Connectors.....	34
1.2.2	Options Information.....	11	4.7.1	Micro USB Type-AB (OTG).....	35
1.2.3	Optional Accessories .....	11	4.7.2	Dual Stacked USB 2.0 Type-A.....	36
2	Connector Layout .....	12	4.7.3	Dual Stacked USB 3.0 Type-A.....	36
3	Specifications .....	14	4.8	SATA Connectors .....	37
3.1	Feature List .....	14	4.8.1	Standard SATA Port .....	37
3.2	Mechanical Dimensions .....	15	4.8.2	SATA Power Connector.....	37
3.3	Environmental Specifications.....	15	4.9	Gigabit Ethernet (GbE) .....	38
4	Connector Description.....	16	4.10	Audio Connectors.....	38
4.1	Power Supply Connectors.....	21	4.10.1	Audio Jack .....	38
4.1.1	DC Power Jack.....	21	4.10.2	Audio Header .....	39
4.1.2	Mini-Fit 4-Pin Connector.....	22	4.11	COM Port Headers .....	40
4.1.3	Power Status LEDs .....	22	4.11.1	COM 0 and 2 (RS232/RS422/RS485) .....	40
4.1.4	VIN_PWR_BAD# Control .....	23	4.11.2	COM 1 and 3 (RS232) .....	41
4.1.5	CMOS Battery Connector.....	23	4.12	GPIO Header .....	42
4.2	Extension Sockets .....	24	4.13	I <sup>2</sup> C Bus/SM Bus Header .....	43
4.2.1	Mini Card Socket.....	25	4.14	eSPI/SPI1 Header.....	43
4.2.2	M.2 Key B Socket.....	26	4.14.1	SPI Device Header .....	44
4.2.3	M.2 Key E Socket.....	26	4.15	Boot Selection Switch .....	45
4.3	SIM Card Slot.....	27	4.16	Force Recovery Switch.....	45
4.4	Micro-SD Card Slot .....	27	4.17	Test Mode/Wireless-Disable Mode.....	46
4.5	Display Connectors.....	28	4.18	CAN Bus Header.....	46
4.5.1	DisplayPort++ .....	28	4.19	CPU Fan Header .....	47
4.5.2	HDMI.....	29	4.20	Front Panel Header.....	48
4.5.3	Optional eDP .....	29	4.21	Feature Connector .....	49
4.5.4	LVDS.....	29	5	Additional Features.....	50
4.5.4.1	Panel Voltage Selection Jumper.....	30	5.1	Buttons.....	50
4.5.4.2	LCD Control Voltage Selection Jumper.....	31	5.2	Debug Feature—Internal Use Only .....	50
4.5.4.3	Backlight Power Header .....	31	6	Mechanical Dimensions .....	51



# List of Tables

Table 1	Order Description .....	10	Table 37	X32 Pinout Description .....	48
Table 2	conga-SMC1 Variants.....	11	Table 38	X31 Pinout Description .....	49
Table 3	Cables.....	11	Table 39	DIP SW6.1 - Test Mode Selection .....	50
Table 4	Feature Summary .....	14			
Table 5	SMARC Edge Finger Connector Pinout.....	16			
Table 6	X33 Pinout Description .....	21			
Table 7	X44 Pinout Description .....	22			
Table 8	D90 LED Status.....	22			
Table 9	SW6.2 - VIN_PWR_BAD# Configuration.....	23			
Table 10	SW6.3 - UIM Route Configuration .....	27			
Table 11	SW6.4 - SD Card Write Protection .....	27			
Table 12	X17 Pinout Description .....	29			
Table 13	JP1 Pinout Description.....	30			
Table 14	X56 Pinout Description .....	31			
Table 15	X19 Pinout Description .....	31			
Table 16	X57 Pinout Description .....	32			
Table 17	X58 Pinout Description .....	33			
Table 18	X7 Pinout Description .....	37			
Table 19	X8 Pinout Description .....	37			
Table 20	GbE LED Description.....	38			
Table 21	X15 Jack Pinout Description .....	39			
Table 22	X64 Pinout Description .....	39			
Table 23	X26/X27 Pinout Description .....	40			
Table 24	DIP SW3 - COM Port Configuration .....	40			
Table 25	X28/X29 Pinout Description .....	41			
Table 26	X37 Pinout Description .....	42			
Table 27	X30 Pinout Description .....	43			
Table 28	CN1 Pinout Description .....	43			
Table 29	X36 Pinout Description .....	44			
Table 30	DIP SW4 - Boot Source Configuration .....	45			
Table 31	DIP SW4.1 Configuration.....	45			
Table 32	Switch SW5 Configuration .....	45			
Table 33	X59 Pinout Description .....	46			
Table 34	X24/X25 Pinout Description .....	46			
Table 35	X38 Pinout Description .....	47			
Table 36	X54 Pinout Description .....	47			

# 1 Introduction

## 1.1 SMARC™ Concept

The Standardization Group for Embedded Technologies e.V (SGET) defined the SMARC standard for small form factor computer modules that target low power, low cost and high performance applications. The SMARC connector and interfaces are optimized for high-speed communication, and are suitable for ARM SoCs and low power x86 SoCs.

The SMARC standard bridges the gap between the COM Express standard and the Qseven standard by offering most of the interfaces defined in the COM Express specification at a lower power. With a footprint of 82 mm x 50 mm or 82 mm x 80 mm, the SMARC standard promotes the design of highly integrated, energy-efficient systems.

Due to its small size and lower power demands, PC appliance designers can design low cost devices as well as explore a huge variety of product development options—from compact space-saving designs to fully functional systems. This solution allows scalability, product diversification and faster time to market.

## 1.2 conga-SMC1

The conga-SMC1 carrier board is designed based on the SMARC 2.1 Specification. With a footprint of 82 mm x 50 mm, the conga-SMC1 provides most of the functional requirements for any SMARC application. These functions include, but are not limited to a rich complement of contemporary high bandwidth serial interfaces such as PCI Express, Serial ATA, USB 3.0/2.0, and Gigabit Ethernet. .

By combining the scalability of SMARC modules, the conga-SMC1 carrier board provides manufacturers and developers with a platform to jump-start the development of ARM-based or x86-based SMARC systems. This helps to reduce product design cycle and encourages rapid innovation in system design, to meet the ever-changing needs of the market.

The conga-SMC1 is an ideal platform for developing ARM-based or x86-based embedded systems because of the various features and capabilities it offers.

### 1.2.1 Order Number

Table 1 Order Description

Part Number	Product Name	Description
020750	conga-SMC1/SMARC-ARM	3.5 " carrier board for SMARC-based ARM modules
020751	conga-SMC1/SMARC-x86	3.5 " carrier board for SMARC-based x86 modules



## 1.2.2 Options Information

The conga-SMC1 is available in two variants—ARM-based and x86-based variants. The table below shows the different configurations available.

Table 2 conga-SMC1 Variants

Features	Description	
Part Number	020750	020751
USB	1 x USB OTG 2 x USB 3.0 Type A 2x USB 2.0 Type A	2 x USB 3.0 Type A 2x USB 2.0 Type A
Audio Codec	WM8904 ultra low I2S codec	ALC888S-VD 7.1 channel HDA codec

## 1.2.3 Optional Accessories

Table 3 Cables

Cables	Part No.	conga-SMC1 Connector	Description
cab-Pico-ITX-Buttons-LED	14000147	X32	15 cm internal buttons and LEDs cable
cab-CAN-cable	14000149	X24, X25	15 cm CAN bus adapter cable with termination (DSUB9 male)
cab-Pico-ITX-GPIO	14000151	X30, X31, X37	15 cm GPIO cable with open end
cab-Pico-ITX-RS232	14000152	X26, X27, X28, X29	15 cm 5-wire RS232 cable adapter (DSUB9 male)
cab-Pico-ITX-RS422	14000153	X26, X27	15 cm 5-wire RS422 cable adapter (DSUB9 male)
cab-Pico-ITX-RS485	14000154	X26, X27	15 cm 5-wire RS485 cable adapter (DSUB9 male)
cab-Backlight ZHR-8	14000253	X19	50 cm backlight cable with ZHR-8 connector and open end
cab-LVDS SHDR-40V	14000254	X17	50 cm, 40-pin LVDS cable with JST SHDR-40 connector and open end
cab-Backlight ZHR-8 51146-0600	14000255	X19	50 cm backlight cable with ZHR-8 connector and Molex 51146-0600
cab-LVDS SHDR-40V FI-X30HL	14000256	X17	50 cm, 40-pin LVDS cable with JST SHDR-40 and JAE FI-X30HL
cab-ThinMini-ITX-Floppy to SATA Power	14000260	X8	20 cm Delock 85248 cable for SATA power
SATA III cable straight/straight	48000029	X5	30 cm SATA III cable with straight-straight connectors
SATA III cable down/straight	48000030	X5	30 cm SATA III cable with down-straight connectors



## 2 Connector Layout

The connector layout picture below shows each connector and its name designator. Jumpers and their respective pins are also shown. Select the Adobe 'Zoom-In-Tool' and zoom in on a given component to see its designator. Hover over the component and the 'Zoom-In-Tool' will change indicating there is a link.

Click on the link to navigate to the area in the document where the component is described. Use the mouse icon in the top left hand corner of the destination page to return to the connector layout picture.

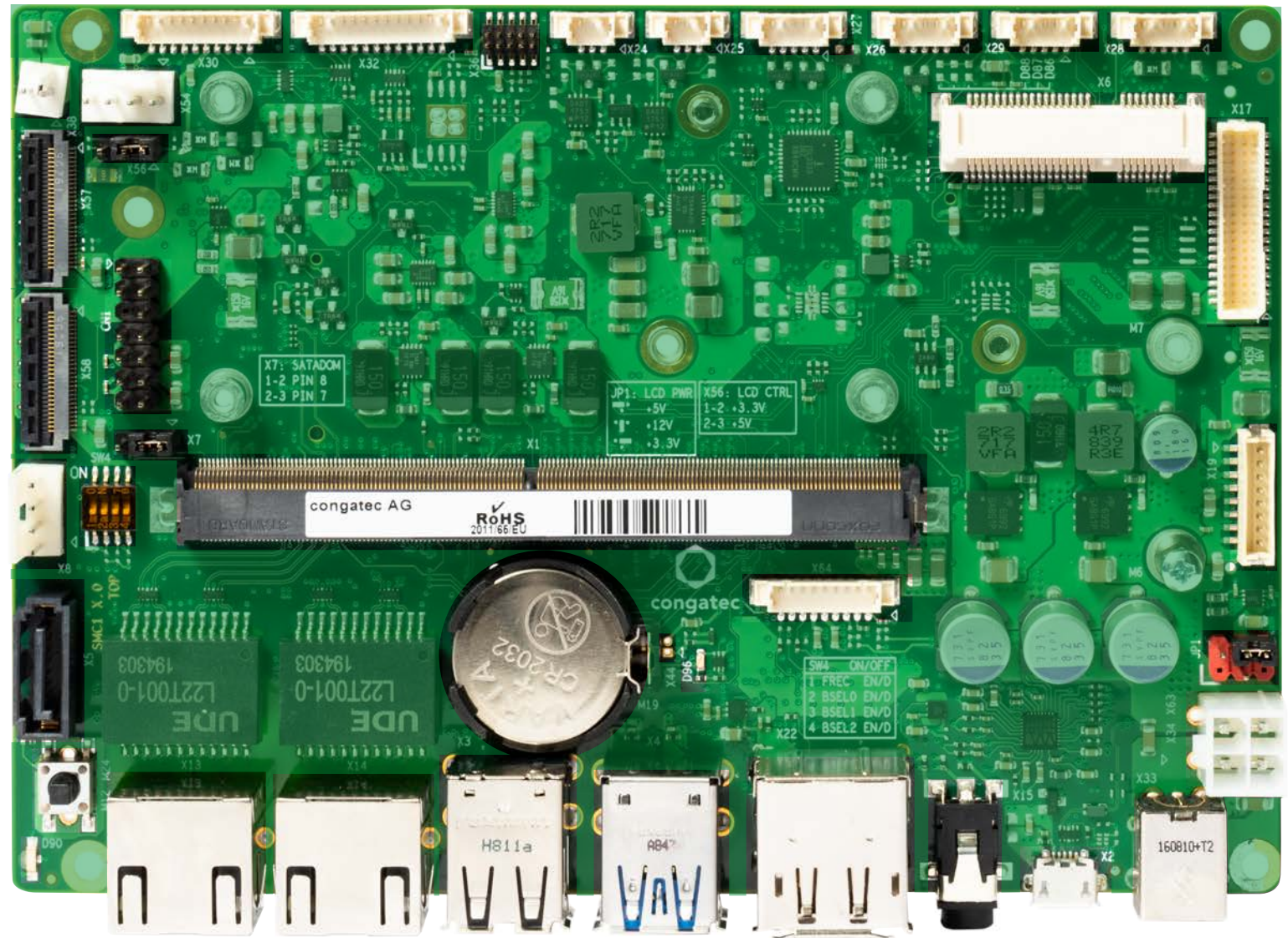

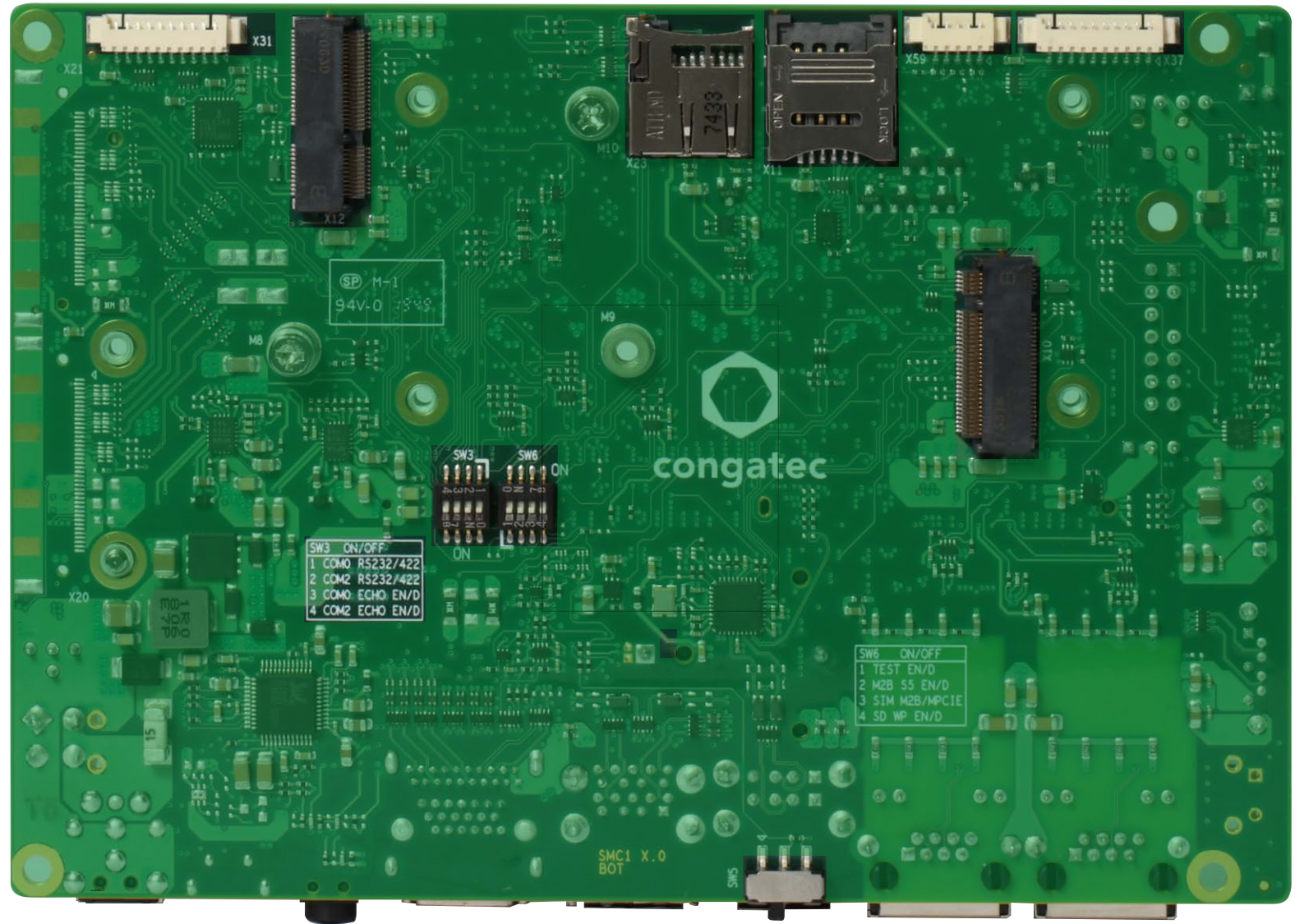



# 3 Specifications

## 3.1 Feature List

Table 4 Feature Summary

<b>Form Factor</b>	3.5 " form factor (146 mm x 102 mm)— SMARC® specification, revision 2.1	
<b>Supported Modules</b>	ARM-based and x86-based SMARC modules	
<b>Back Panel Connectors</b>	1 x DC-IN 2 x Gigabit Ethernet RJ45 port 1 x HDMI port 1 x DP++	1 x Audio-Out/MIC jack 1 x USB OTG <sup>1</sup> 2 x USB 3.0 host ports 2 x USB 2.0 host ports
<b>Onboard Connectors and Features</b>	Extension Sockets: <ul style="list-style-type: none"> <li>- 1 x M.2 key B, type 2280/2242/3042 (PCIe x2/USB/SIM)</li> <li>- 1 x M.2 key E, type 2230 (PCIe x1/USB)</li> <li>- 1 x Mini Card full-size or half-size (PCIe x1/USB)</li> </ul> SATA Connectors <ul style="list-style-type: none"> <li>- 1 x Standard SATA 3.0/SATADOM</li> <li>- 1 x SATA power header (5 V and 12 V)</li> </ul> 1 x Internal audio header (Line-Out, DMIC) 1 x Mini-FIT power connector 1 x LVDS connector 1 x Backlight power connector 1 x CPU fan header 2 x CAN headers 2 x MIPI-CSI2	1 x Micro-SIM card slot 2 x RS 232/422/485 header (COM 0 and COM 2) 2 x RS 232 header (COM 1 and COM 3) 1 x Front panel header (power button, reset,sleep, LEDs) 1 x Feature connector (batlow, battery charging, GbE SDP, watchdog) 1 x GPIO header 1 x SPI/eSPI header 1 x SMB/I2C header 1 x Micro-SD slot 1 x CR2032 CMOS/RTC battery 1 x Power button 1 x Power status LED
<b>Optional Onboard Interfaces</b>	2x eDP with LVDS overlay (bottom-side)	
<b>Other Features</b>	Boot from external BIOS flash	



- Note**
- <sup>1</sup> Available only on ARM-based variant (PN:020750)
  - <sup>2</sup> The module must also support the features for them to function. Refer to the module's user's guide for information about supported features.



## 3.2 Mechanical Dimensions

The conga-SMC1 has the following dimensions:

- length of  $146 \pm 0.1$  mm
- width of  $102 \pm 0.1$  mm
- height of 25.1 mm (19.3 mm top-side, 1.6 mm PCB and 4.2 mm bottom-side)

## 3.3 Environmental Specifications

Temperature	Operation: 0°C to 60°C	Storage: -20° to +70°C (commercial temperature)
-------------	------------------------	---

Humidity	Operation: 10% to 90%	Storage: 5% to 95%
----------	-----------------------	--------------------



### Note

*The above operating temperatures must be strictly adhered to at all times. The maximum operating temperature refers to any measurable spot on the modules surface.*

*Humidity specifications are for non-condensing conditions.*



## 4 Connector Description

Table 5 SMARC Edge Finger Connector Pinout

P-PIN	Primary (Top) Side	S-Pin	Secondary (Bottom) Side
		S1	CSI1_TX+ / I2C_CAM1_CK
P1	SMB_ALERT#	S2	CSI1_TX- / I2C_CAM1_DAT
P2	GND	S3	GND
P3	CSI1_CK+	S4	RSVD <sup>2</sup>
P4	CSI1_CK-	S5	CSI0_TX- / I2C_CAM0_CK
P5	GBE1_SDP	S6	CAM_MCK
P6	GBE0_SDP	S7	CSI0_TX+ / I2C_CAM0_DAT
P7	CSI1_RX0+	S8	CSI0_CK+
P8	CSI1_RX0-	S9	CSI0_CK-
P9	GND	S10	GND
P10	CSI1_RX1+	S11	CSI0_RX0+
P11	CSI1_RX1-	S12	CSI0_RX0-
P12	GND	S13	GND
P13	CSI1_RX2+	S14	CSI0_RX1+
P14	CSI1_RX2-	S15	CSI0_RX1-
P15	GND	S16	GND
P16	CSI1_RX3+	S17	GBE1_MDI0+
P17	CSI1_RX3-	S18	GBE1_MDI0-
P18	GND	S19	GBE1_LINK100#
P19	GBE0_MDI3-	S20	GBE1_MDI1+
P20	GBE0_MDI3+	S21	GBE1_MDI1-
P21	GBE0_LINK100#	S22	GBE1_LINK1000#
P22	GBE0_LINK1000#	S23	GBE1_MDI2+
P23	GBE0_MDI2-	S24	GBE1_MDI2-
P24	GBE0_MDI2+	S25	GND
P25	GBE0_LINK_ACT#	S26	GBE1_MDI3+
P26	GBE0_MDI1-	S27	GBE1_MDI3-
P27	GBE0_MDI1+	S28	GBE1_CTREF





P-PIN	Primary (Top) Side	S-Pin	Secondary (Bottom) Side
P28	GBE0_CTREF	S29	PCIE_D_TX+
P29	GBE0_MDIO-	S30	PCIE_D_TX-
P30	GBE0_MDIO+	S31	GBE1_LINK_ACT#
P31	SPI0_CS1#	S32	PCIE_D_RX+
P32	GND	S33	PCIE_D_RX-
P33	SDIO_WP	S34	GND
P34	SDIO_CMD	S35	USB4+
P35	SDIO_CD#	S36	USB4-
P36	SDIO_CK	S37	USB3_VBUS_DET <sup>2</sup>
P37	SDIO_PWR_EN	S38	AUDIO_MCK
P38	GND	S39	I2S0_LRCK <sup>2,3</sup>
P39	SDIO_D0	S40	I2S0_SDOUT <sup>2,3</sup>
P40	SDIO_D1	S41	I2S0_SDIN <sup>2,3</sup>
P41	SDIO_D2	S42	I2S0_CK <sup>2,3</sup>
P42	SDIO_D3	S43	ESPI_ALERT0#
P43	SPI0_CS0#	S44	ESPI_ALERT1#
P44	SPI0_CK	S45	MDIO_CLK <sup>1</sup>
P45	SPI0_DIN	S46	MDIO_DAT <sup>1</sup>
P46	SPI0_DO	S47	GND
P47	GND	S48	I2C_GP_CK
P48	SATA_TX+	S49	I2C_GP_DAT
P49	SATA_TX-	S50	HDA_SYNC / I2S2_LRCK
P50	GND	S51	HDA_SDO / I2S2_SDOUT
P51	SATA_RX+	S52	HDA_SDI / I2S2_SDIN
P52	SATA_RX-	S53	HDA_CK / I2S2_CK
P53	GND	S54	SATA_ACT#
P54	ESPI_CS0#	S55	USB5_EN_OC#
P55	ESPI_CS1#	S56	ESPI_IO_2
P56	ESPI_CK	S57	ESPI_IO_3
P57	ESPI_IO_1	S58	ESPI_RESET#
P58	ESPI_IO_0	S59	USB5+
P59	GND	S60	USB5-



P-PIN	Primary (Top) Side	S-Pin	Secondary (Bottom) Side
P60	USB0+	S61	GND
P61	USB0-	S62	USB3_SSTX+
P62	USB0_EN_OC#	S63	USB3_SSTX-
P63	USB0_VBUS_DET	S64	GND
P64	USB0_OTG_ID	S65	USB3_SSRX+
P65	USB1+	S66	USB3_SSRX-
P66	USB1-	S67	GND
P67	USB1_EN_OC#	S68	USB3+
P68	GND	S69	USB3-
P69	USB2+	S70	GND
P70	USB2-	S71	USB2_SSTX+
P71	USB2_EN_OC#	S72	USB2_SSTX-
P72	RSVD <sup>2</sup>	S73	GND
P73	RSVD <sup>2</sup>	S74	USB2_SSRX+
P74	USB3_EN_OC#	S75	USB2_SSRX-
	Key		Key
P75	PCIE_A_RST#	S76	PCIE_B_RST#
P76	USB4_EN_OC#	S77	PCIE_C_RST#
P77	PCIE_B_CKREQ#	S78	PCIE_C_RX+
P78	PCIE_A_CKREQ#	S79	PCIE_C_RX-
P79	GND	S80	GND
P80	PCIE_C_REFCK+	S81	PCIE_C_TX+
P81	PCIE_C_REFCK-	S82	PCIE_C_TX-
P82	GND	S83	GND
P83	PCIE_A_REFCK+	S84	PCIE_B_REFCK+
P84	PCIE_A_REFCK-	S85	PCIE_B_REFCK-
P85	GND	S86	GND
P86	PCIE_A_RX+	S87	PCIE_B_RX+
P87	PCIE_A_RX-	S88	PCIE_B_RX-
P88	GND	S89	GND



P-PIN	Primary (Top) Side	S-Pin	Secondary (Bottom) Side
P89	PCIE_A_TX+	S90	PCIE_B_TX+
P90	PCIE_A_TX-	S91	PCIE_B_TX-
P91	GND	S92	GND
P92	HDMI_D2+	S93	DP0_LANE0+
P93	HDMI_D2-	S94	DP0_LANE0-
P94	GND	S95	DP0_AUX_SEL
P95	HDMI_D1+	S96	DP0_LANE1+
P96	HDMI_D1-	S97	DP0_LANE1-
P97	GND	S98	DP0_HPD
P98	HDMI_D0+	S99	DP0_LANE2+
P99	HDMI_D0-	S100	DP0_LANE2-
P100	GND	S101	GND
P101	HDMI_CK+	S102	DP0_LANE3+
P102	HDMI_CK-	S103	DP0_LANE3-
P103	GND	S104	USB3_OTG_ID
P104	HDMI_HPD	S105	DP0_AUX+
P105	HDMI_CTRL_CK	S106	DP0_AUX-
P106	HDMI_CTRL_DAT	S107	LCD1_BKLT_EN
P107	DP1_AUX_SEL <sup>1</sup>	S108	LVDS1_CK+ / eDP1_AUX+ / DSI1_CLK+
P108	GPIO0 / CAM0_PWR#	S109	LVDS1_CK- / eDP1_AUX- / DSI1_CLK-
P109	GPIO1 / CAM1_PWR#	S110	GND
P110	GPIO2 / CAM0_RST#	S111	LVDS1_0+ / eDP1_TX0+ / DSI1_D0+
P111	GPIO3 / CAM1_RST#	S112	LVDS1_0- / eDP1_TX0- / DSI1_D0-
P112	GPIO4 / HDA_RST#	S113	eDP1_HPD
P113	GPIO5 / PWM_OUT	S114	LVDS1_1+ / eDP1_TX1+ / DSI1_D1+
P114	GPIO6 / TACHIN	S115	LVDS1_1- / eDP1_TX1- / DSI1_D1-
P115	GPIO7	S116	LCD1_VDD_EN
P116	GPIO8	S117	LVDS1_2+ / eDP1_TX2+ / DSI1_D2+
P117	GPIO9	S118	LVDS1_2- / eDP1_TX2- / DSI1_D2-
P118	GPIO10	S119	GND
P119	GPIO11	S120	LVDS1_3+ / eDP1_TX3+ / DSI1_D3+
P120	GND	S121	LVDS1_3- / eDP1_TX3- / DSI1_D3-
P121	I2C_PM_CK	S122	LCD1_BKLT_PWM



P-PIN	Primary (Top) Side	S-Pin	Secondary (Bottom) Side
P122	I2C_PM_DAT	S123	GPIO13
P123	BOOT_SELO#	S124	GND
P124	BOOT_SEL1#	S125	LVDS0_0+ / eDP0_TX0+ / DSI0_D0+
P125	BOOT_SEL2#	S126	LVDS0_0- / eDP0_TX0- / DSI0_D0-
P126	RESET_OUT#	S127	LCD0_BKLT_EN
P127	RESET_IN#	S128	LVDS0_1+ / eDP0_TX1+ / DSI0_D1+
P128	POWER_BTN#	S129	LVDS0_1- / eDP0_TX1- / DSI0_D1-
P129	SER0_TX	S130	GND
P130	SER0_RX	S131	LVDS0_2+ / eDP0_TX2+ / DSI0_D2+
P131	SER0_RTS#	S132	LVDS0_2- / eDP0_TX2- / DSI0_D2-
P132	SER0_CTS#	S133	LCD0_VDD_EN
P133	GND	S134	LVDS0_CK+ / eDP0_AUX+ / DSI0_CLK+
P134	SER1_TX	S135	LVDS0_CK- / eDP0_AUX- / DSI0_CLK-
P135	SER1_RX	S136	GND
P136	SER2_TX	S137	LVDS0_3+ / eDP0_TX3+ / DSI0_D3+
P137	SER2_RX	S138	LVDS0_3- / eDP0_TX3- / DSI0_D3-
P138	SER2_RTS#	S139	I2C_LCD_CK
P139	SER2_CTS#	S140	I2C_LCD_DAT
P140	SER3_TX	S141	LCD0_BKLT_PWM
P141	SER3_RX	S142	GPIO12
P142	GND	S143	GND
P143	CAN0_TX	S144	eDP0_HPD
P144	CAN0_RX	S145	WDT_TIME_OUT#
P145	CAN1_TX	S146	PCIE_WAKE#
P146	CAN1_RX	S147	VDD_RTC
P147	VDD_IN	S148	LID#
P148	VDD_IN	S149	SLEEP#
P149	VDD_IN	S150	VIN_PWR_BAD#
P150	VDD_IN	S151	CHARGING#
P151	VDD_IN	S152	CHARGER_PRSENT#
P152	VDD_IN	S153	CARRIER_STBY#
P153	VDD_IN	S154	CARRIER_PWR_ON
P154	VDD_IN	S155	FORCE_RECOV#



P-PIN	Primary (Top) Side	S-Pin	Secondary (Bottom) Side
P155	VDD_IN	S156	BATLOW#
P156	VDD_IN	S157	TEST#
		S158	GND



- Note**
- Not supported*
  - Not connected*
  - Optional connection to M.2 key E socket (assembly option)*

## 4.1 Power Supply Connectors

The conga-SMC1 provides a DC power jack and a 4-pin Mini-Fit connector. The attached SMARC or ARM module turns on when you press the power button M12. The power input is protected by a 15 A non-resettable fuse.



*We recommend a maximum input current of 8 A.*

### 4.1.1 DC Power Jack

The conga-SMC1 provides DC power jack X33. The power input has a 15A fuse and reverse voltage protection.

Table 6 X33 Pinout Description

Pin	Function
Inner Shell	+12-24V $\pm$ 5%
Outer Shell	GND



X33: DC power plug (7.4 x 5.1 mm)

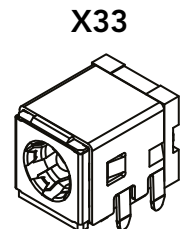



## 4.1.2 Mini-Fit 4-Pin Connector

The conga-SMC1 provides an internal 4-pin Mini-Fit connector X34.

Table 7 X44 Pinout Description

Pin	Signal	Description
1	GND	Ground
2	GND	Ground
3	+12V-24V	Power supply +12-24V ± 5%
4	+12V-24V	Power supply +12-24V ± 5%

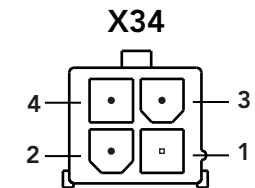

The conga-SMC1 offers an optional right-angle, 2-pin Weidmuller OMNIMATE SL 5.08HC/02/90 connector (BOM option).

### Connector Type

X34: 2 x 2-pin, 4.2 mm pitch Mini-Fit connector (Molex 87427-0442)

Possible Mating Connector: Molex 39012040

## 4.1.3 Power Status LEDs

The bi-color LED D90 shows the power state of the conga-SMC1 as described in the table below. Optionally, you can connect an LED to pins 9 and 10 of connector X32 for power state indication (see section 4.20 "Front Panel Header").

Table 8 D90 LED Status

LED Status	ACPI State	Description
Green - Steady on	S0	System on and running
Red - Steady on	Pseudo G3	Deep sleep with minimum power consumption
Green - Blinking	S3-S5	Standby or Suspend to RAM/Disk



## 4.1.4 VIN\_PWR\_BAD# Control

With switch 2 of DIP SW6, you can connect or disconnect the power bad indication to the SMARC module. The signal indicates that the SMARC module power (+5 V) is running and stable (active high).

Table 9 SW6.2 - VIN\_PWR\_BAD# Configuration

Switch	Configuration	Description
SW6.2	OFF	Disconnect optional VIN_PWR_BAD# signal (default)
	ON	Connect optional VIN_PWR_BAD# signal

SW6.2

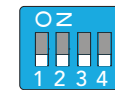

## 4.1.5 CMOS Battery Connector

The conga-SMC1 provides battery holder M19 for attaching CR2032 CMOS battery. The battery supplies power to maintain the CMOS settings and real time clock.

The conga-SMC1 also offers an optional (BOM option) 2-pin connector X44 for external RTC backup solution.

M19



X44

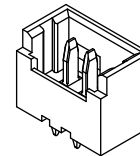

### Warning

*Danger of explosion if battery is incorrectly replaced. Replace only with the same or equivalent type recommended by the manufacturer. Dispose of used batteries according to the manufacturer's instructions.*



### Connector Type

X44: 1.25 mm, 2-pin PicoBlade header (Molex 530470210)

Possible Mating Connector: Molex 51021-0200



## 4.2 Extension Sockets

The conga-SMC1 provides the following extension sockets:

- Mini Card—full or half size (PCIe x1/USB/SIM)
- M.2 key B, type 2280/3042 (PCIe x2/USB/SIM)
- M.2 key E, type 2230 (PCIe x1/USB)

The PCIe lanes are routed as shown below:

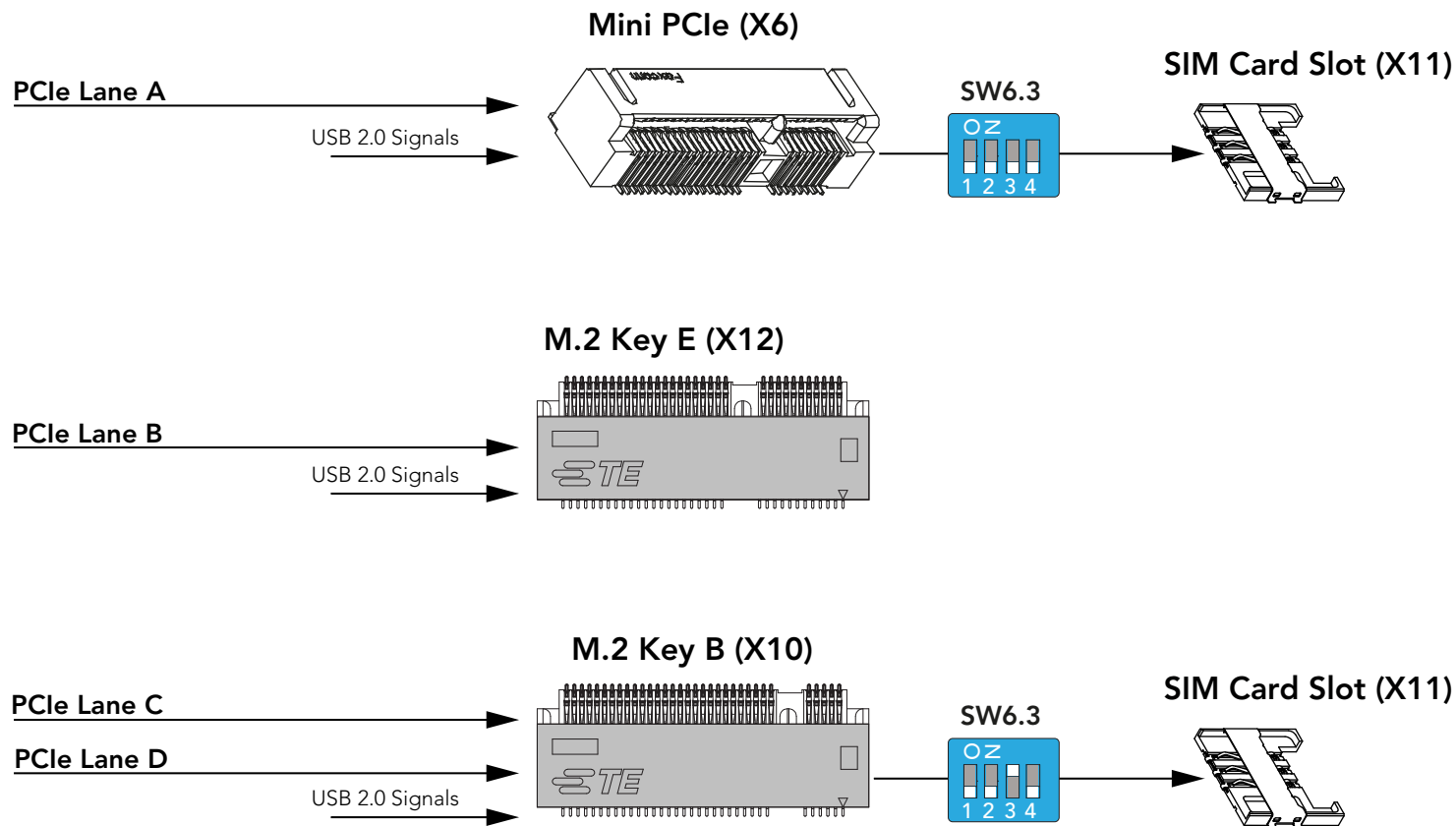





## PCIe Link Configuration

The illustration below shows the recommended PCIe configuration for SMARC modules.

Module		PCI Express Lanes			
		0	1	2	3
		Carrier board devices			
conga-SMC1	Connector	X6	X12	X10	
	Possible Configuration	x1	x1 (Wifi)	x2 (PCIe SSD)	
		x1	x1 (Wifi)	x1 (WWAN)	Disable

### 4.2.1 Mini Card Socket

The conga-SMC1 provides a Mini Card socket X6. The socket supports full or half size PCIe or USB 2.0 cards or both.

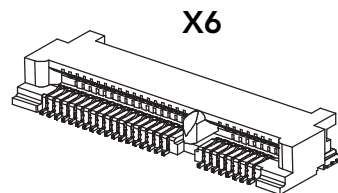

#### Note

Use switch 3 of DIP SW6 to route the UIM signals from mini Card socket to M.2 type B socket.

#### Connector Type

X6: Mini PCIe card



## 4.2.2 M.2 Key B Socket

The conga-SMC1 provides an M.2 key B, type 2280/3042 socket X10 for connecting a PCIe WLAN card.

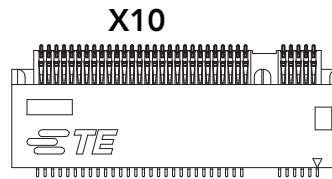

### Note

Use switch 3 of DIP SW6 to route the UIM signals from mini Card socket to M.2 type B socket.

### Connector Type

X10: M.2 card size 2280/3042

## 4.2.3 M.2 Key E Socket

The conga-SMC1 provides an M.2 key E, type 2230 socket (X12) for connecting a PCIe WLAN card.

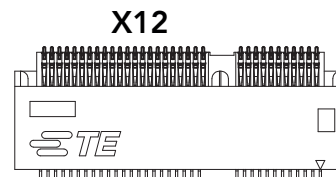

### Connector Type

X12: M.2 card size 2230



## 4.3 SIM Card Slot

The conga-SMC1 features a micro-SIM card slot on connector X11. The slot is connected to the UIM interface of the mPCIe slot by default. To route the UIM signals from the mPCIe slot to M.2 type B socket, use switch 3 of DIP SW6.

Table 10 SW6.3 - UIM Route Configuration

Switch	Configuration	Description
SW6.3	OFF	Route SIM card signals from mPCIe slot (default)
	ON	Route SIM card signals from M.2 key B socket



### Connector Type

X11: Micro-SIM Card

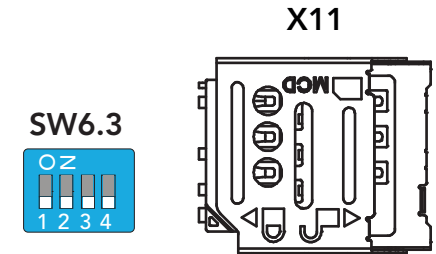

## 4.4 Micro-SD Card Slot

The conga-SMC1 features a micro-SD card slot on connector X23. Use switch 4 of DIP SW6 to control the SD card write protection.

Table 11 SW6.4 - SD Card Write Protection

Switch	Configuration	Description
SW6.4	OFF	Enable SD card write protection
	ON	Disable SD card write protection (default)



### Connector Type

X23: Micro-SD card

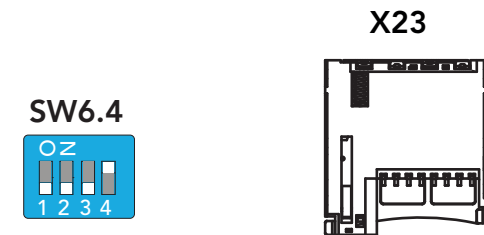



## 4.5 Display Connectors

The conga-SMC1 provides the following display interfaces:

- dual-mode DisplayPort (DP++)
- native HDMI
- optional eDP
- LVDS/DSI

### 4.5.1 DisplayPort++

The conga-SMC1 provides a DP++ port on connector X22 (upper port). You can connect a DP++ to HDMI dongle to the DP++ port if your module supports it.

**X22**

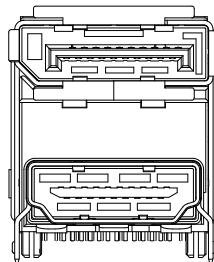

#### Connector Type

X22: Standard DP cable



## 4.5.2 HDMI

The conga-SMC1 provides an HDMI port on connector X22 (lower port). To use this port, the attached ARM or x86 module must support native HDMI functionality.

**X22**

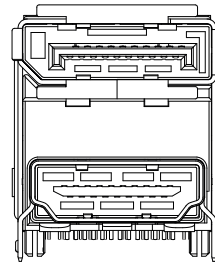

### Connector Type

X22: HDMI cable

## 4.5.3 Optional eDP

The conga-SMC1 offers two optional eDP connectors (X20 and X21) via BOM option. Alternatively, a MIPI-DSI interface can be routed to connectors X20 or X21 or both if the ARM or x86 module supports it.

## 4.5.4 LVDS

The conga-SMC1 supports a dual-channel LVDS panel on connector X17. Use jumper JP1 to set the LCD power to 3.3 V, 5 V or 12 V.

**Table 12 X17 Pinout Description**

Pin	Signal	Pin	Signal
1	VCC (fuse with 1.5 A hold current at 25°C)	2	VCC (fuse with 1.5 A hold current at 25°C)
3	VCC (fuse with 1 A hold current at 25°C)	4	VCC (fuse with 1.5 A hold current at 25°C)
5	VCC_EDID (+3.3 V)	6	GND
7	I2C_LCD_CK (EDID_CLK)	8	I2C_LCD_DAT (EDID_DATA)
9	N.C	10	LCD0_VDD_EN (enable for external VCC source; 3.3V or 5V level output control via X56)
11	GND	12	GND

**X17**

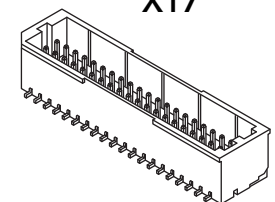



13	LVDS0_0-	14	LVDS0_1-
15	LVDS0_0+	16	LVDS0_1+
17	GND	18	GND
19	LVDS0_2-	20	LVDS0_CK-
21	LVDS0_2+	22	LVDS0_CK+
23	GND	24	GND
25	LVDS0_3-	26	LVDS1_0-
27	LVDS0_3+	28	LVDS1_0+
29	GND	30	GND
31	LVDS1_1-	32	LVDS1_2-
33	LVDS1_1+	34	LVDS1_2+
35	GND	36	GND
37	LVDS1_CK-	38	LVDS1_3-
39	LVDS1_CK+	40	LVDS1_3+



**Note**  
LVDS0 is the primary (ODD) LVDS channel and LVDS1 is the secondary (EVEN) LVDS channel.

### Connector Type

X17: 40-pin, 1 mm pitch header (JST BM40B-SRDS-G-TF)  
Possible Mating Connector: JST SHDR-40V-S-B

#### 4.5.4.1 Panel Voltage Selection Jumper

The conga-SMC1 (connector X17) supports 3.3V, 5V and 12V LCD panels. Use jumper JP1 to set the panel voltage.

Table 13 JP1 Pinout Description

Jumper	Panel Voltage
2-4	5V
3-4	12V
4-6	3.3V (default)

### Connector Type

JP1: 2.54 mm grid jumper

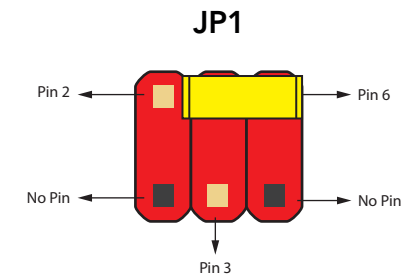



#### 4.5.4.2 LCD Control Voltage Selection Jumper

The conga-SMC1 supports LCD power enable and backlight control signals with 3.3 V or 5 V. Use jumper X56 to select the voltage level.

Table 14 X56 Pinout Description

Jumper	LCD Control Voltage
1-2	3.3V (default)
2-3	5V

Jumper X56

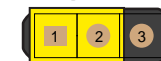

#### Connector Type

X56: 2.54 mm grid jumper

#### 4.5.4.3 Backlight Power Header

The conga-SMC1 provides header X19. The backlight power is protected by a 1.5 A resettable fuse (hold current at 25°C).

Table 15 X19 Pinout Description

Pin	Signal Name	Description
1	+12V	12 V backlight inverter power (1.5 A fuse)
2	+12V	12 V backlight inverter power (1.5 A fuse)
3	GND	Backlight ground
4	GND	Backlight ground
5	LVDS_BKLT_EN	Backlight enable
6	LVDS_BKLT_CTRL	Backlight control
7	+5V	5 V backlight inverter power (1.5 A fuse)
8	+5V	5 V backlight inverter power (1.5 A fuse)

X19

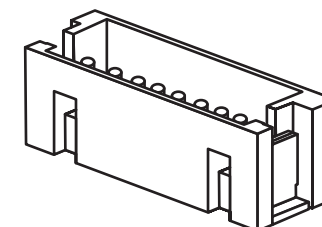

#### Note

The backlight enable and control signals are 3.3 V or 5 V output signals. Select the voltage level with jumper X56.

#### Connector Type

X19: 2 mm, 8-pin Crimp style connector (JST B8B-ZR-SM4-TF)

Possible Mating Connector: JST ZHR-8



## 4.6 MIPI-CSI Connectors

The conga-SMC1 provides two MIPI-CSI connectors (X57 and X58). Each connector supports one camera interface. Each camera has a maximum current of 500 mA.

### 4.6.1 CSI0 Interface

The CSI0 interface—the first camera interface (X57) supports up to two differential data lanes

Table 16 X57 Pinout Description

Pin	Signal	Pin	Signal
1	GND	15	CSI0_RX0-
2	N.C	16	GND
3	N.C	17	N.C
4	GND	18	N.C
5	N.C	19	GND
6	N.C	20	I2C_CAM0_CK
7	GND	21	I2C_CAM0_DAT
8	CSI0_CK+	22	GND
9	CSI0_CK-	23	N.C
10	GND	24	N.C
11	CSI0_RX1+	25	+V5S
12	CSI0_RX1-	26	+V5S
13	GND	27	+V5S
14	CSI0_RX0+	28	GND

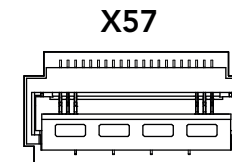

#### Connector Type

X57: 0.5 mm pitch, 28-pin flat foil connector (Hirose FH41-28S-0.5SH(05))





## 4.6.2 CSI1 Interface

The CSI1 interface—second camera interface (X58) supports up to four differential data lanes

Table 17 X58 Pinout Description

Pin	Signal	Pin	Signal
1	GND	15	CSI1_RX0-
2	CSI1_RX3+	16	GND
3	CSI1_RX3-	17	N.C
4	GND	18	N.C
5	CSI1_RX2+	19	GND
6	CSI1_RX2-	20	I2C_CAM1_CK
7	GND	21	I2C_CAM1_DAT
8	CSI1_CK+	22	GND
9	CSI1_CK-	23	N.C
10	GND	24	N.C
11	CSI1_RX1+	25	+V5S
12	CSI1_RX1-	26	+V5S
13	GND	27	+V5S
14	CSI1_RX0+	28	GND

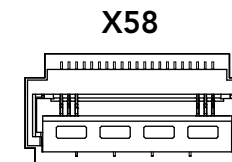

### Connector Type

X58: 0.5 mm pitch, 28-pin flat foil connector (Hirose FH41-28S-0.5SH(05))



## 4.7 USB Connectors

The conga-SMC1 provides the following USB connectors:

- Micro USB Type-AB (ARM-based variant only)
- Stacked Dual USB 2.0 Type-A
- Stacked Dual USB 3.0 Type-A

The USB signals are also routed to M.2 and mPCIe interfaces as shown below:

### ARM-Based Variants (PN: 020750)

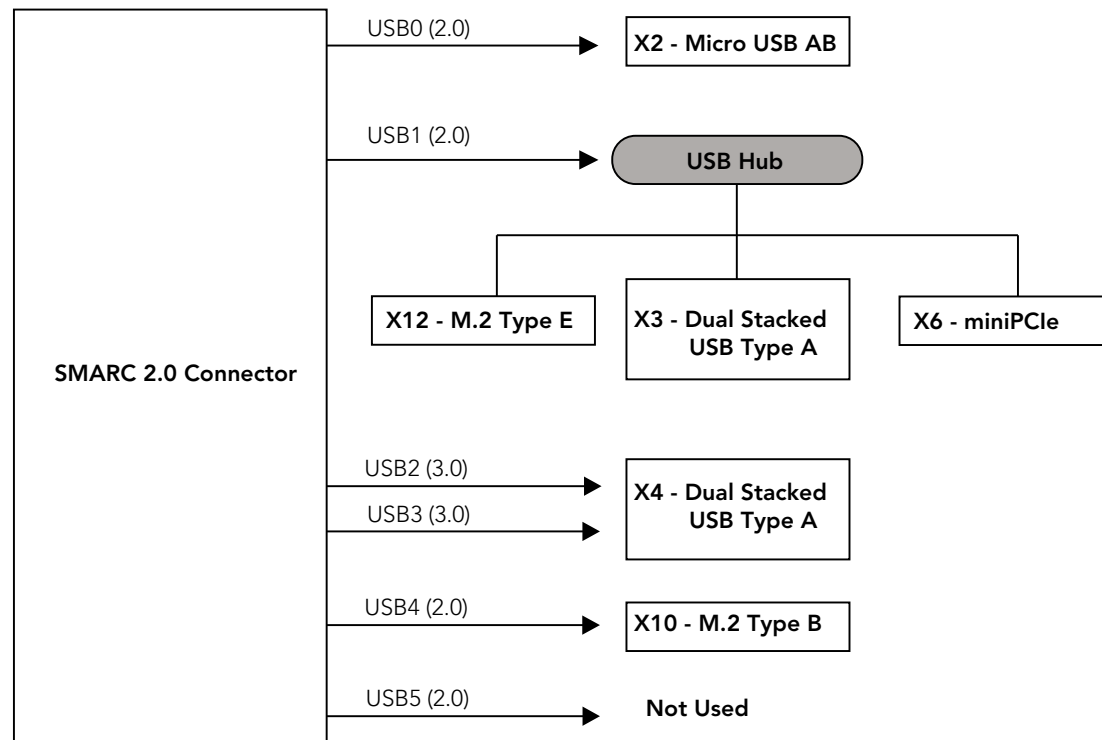



## x86-Based Variants (PN: 020751)

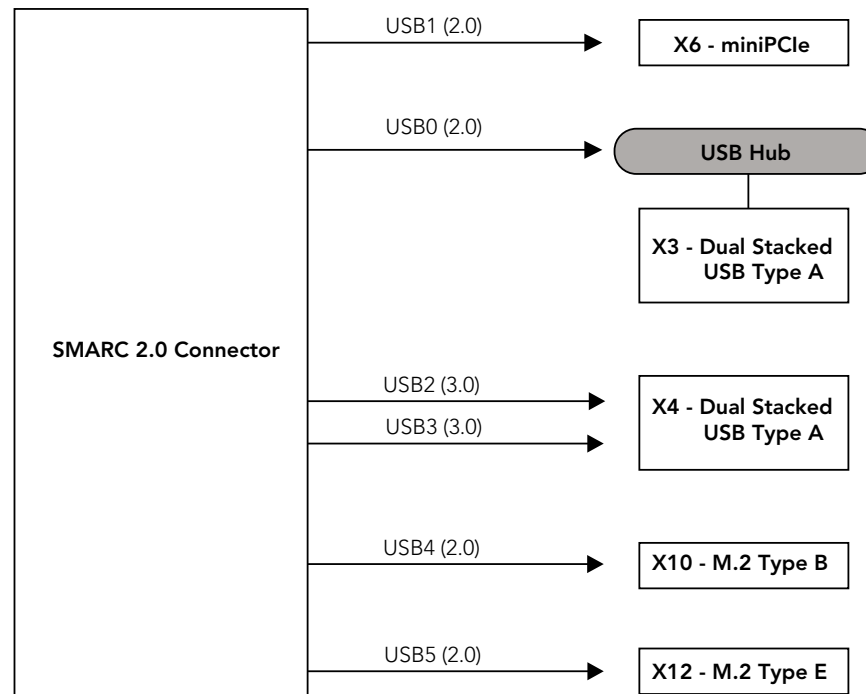

### 4.7.1 Micro USB Type-AB (OTG)

The conga-SMC1 features a micro USB Type-AB port with OTG capability on connector X2.

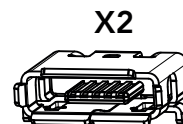

#### Note

*Available only on ARM-based variant.*

#### Connector Type

X2: Micro USB Type AB receptacle



## 4.7.2 Dual Stacked USB 2.0 Type-A

The conga-SMC1 provides two USB 2.0 ports via connector X3. Each port provides up to 500 mA.

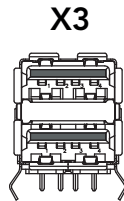

### Connector Type

X3: USB Type A receptacle

## 4.7.3 Dual Stacked USB 3.0 Type-A

The conga-SMC1 provides two USB 3.0 ports via connector X4. Each port provides up to 1 A.

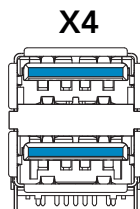

### Connector Type

X4: USB Type A receptacle



## 4.8 SATA Connectors

The conga-SMC1 provides a standard SATA 3.0 port and a SATA power header.

### 4.8.1 Standard SATA Port

The conga-SMC1 provides a standard SATA port via connector X5. The port supports SATA, SATADOM pin 7 or SATADOM pin 8 devices. The maximum output current for a SATADOM device is 500 mA. For SATADOM devices, use jumper X7 to configure the power source (pin 7 or 8).

To show SATA port activity, connect an LED to pin 11 and 12 of the front panel connector X32.

Table 18 X7 Pinout Description

Jumper	SATADOM Power Source
1-2	SATADOM Pin 8 (default)
2-3	SATADOM Pin 7

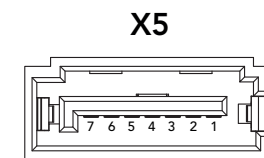
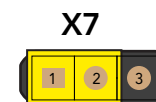

#### Connector Type

X5: Standard SATA cable

### 4.8.2 SATA Power Connector

The conga-SMC1 provides a 4-pin SATA power connector X8 for HDD or SSD.

Table 19 X8 Pinout Description

Pin	Signal
1	+5 V (1.5 A fuse)
2	GND
3	GND
4	+12 V (1.5 A fuse)

#### Connector Type

X8: 2.5 mm pitch, 4-pin header (TE 171825-4) )

Possible Mating Connector: TE 171822-4

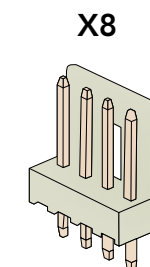



## 4.9 Gigabit Ethernet (GbE)

The conga-SMC1 provides two GbE connectors (X13 and X14). The software definable pins for the GbE interfaces are connected to pins 6 and 7 of connector X31. These pins may be used to synchronize all clocks within a network (via PTP) or for hardware or software-control purposes.

Table 20 GbE LED Description

LED Left Side	Description	LED Right Side	Description
Off	No link	Off	10 Mbps link speed
Steady On	Link established, no activity detected	Orange	100 Mbps link speed
Blinking	Link established, activity detected	Green	1000 Mbps link speed

**X13/X14**

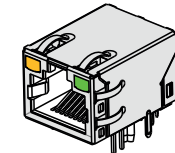

### Connector Type

X13, X14: RJ45 cable plug

## 4.10 Audio Connectors

The conga-SMC1 features two audio codecs—HDA (Realtek ALC888S-VD) codec on x86-based variant and I<sup>2</sup>S (Cirrus Logic WM8904) codec on ARM-based variant. The codecs support the following signals:

- audio-OUT and MIC-IN signals via audio jack X15
- digital MIC and Line-OUT signals via audio header X64

### 4.10.1 Audio Jack

The conga-SMC1 provides headphone-OUT or stereo Line-OUT and MIC-IN signals on connector X15. The pinout of the connector is compliant with the Cellular Telecommunications Industry Association (CTIA) standard by default.

For Open Mobile Terminal Platform (OMTP) standard, you need a customized conga-SMC1 variant (BOM option).



*Jack detection is not supported.*



Table 21 X15 Jack Pinout Description

Pin	Jack	Signal	Description
1	Tip	OUT_L	Left audio out
2	First Ring	OUT_R	Right audio out
3	Second Ring	A_GND	Analog ground
3	Sleeve	MIC	Microphone input

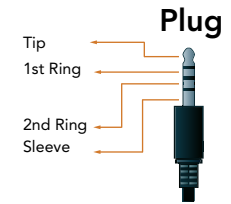

### Connector Type

X15: 3.5 mm TRRS audio plug

## 4.10.2 Audio Header

The conga-SMC1 provides digital MIC and LINE-OUT signals on internal audio header X64.

Table 22 X64 Pinout Description

Pin	Signal	Description
1	HDA_I2S_FRONT_R	Analog front - right channel
2	HDA_I2S_FRONT_L	Analog front - left channel
3	A_GND	Analog ground (return path for analog front)
4	N.C./HDA_FRONT_JD	For I2S (PN: 020750): Not connected For HDA (PN: 020751): Jack detection for analog front output
5	+5V	5 V power supply (protected by 500 mA resetable fuse)
6	VCC	3.3 V power supply for HDA DMIC or 1.8 V power supply for I2S DMIC (protected by 500 mA resetable fuse)
7	DMIC_DATA	Serial data from digital MIC For I2S (PN: 020750): 1.8 V level For HDA (PN: 020751): 3.3 V level
8	GND	Ground reference for DMIC
9	DMIC_CLK	Digital MIC serial clock For I2S (PN: 020750): 1.8 V level For HDA (PN: 020751): 3.3 V level

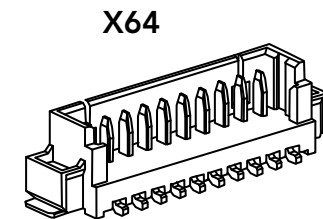

### Connector Type

X64: 9-pin, 1.25 mm pitch picoblade header (Molex 0533980971)

Possible Mating Connector: Molex 0510210900



## 4.11 COM Port Headers

The conga-SMC1 provides four COM ports:

- COM port 0 and 2 via ISL3333 transceiver
- COM port 1 and 3 via ISL3243E transceiver

### 4.11.1 COM 0 and 2 (RS232/RS422/RS485)

The conga-SMC1 provides COM port 0 on pin header X26 and COM port 2 on pin header X27. Both ports support RS 232 or RS422/RS485 voltage level. Use DIP SW3 to select the serial communication standard.



- Note**
1. If 120 ohm bus termination is required, add a termination resistor to the cable or cable adapter.
  2. RS485 mode supports Tx output control and Rx echo cancellation if the attached module supports active-low RTS signal.
  3. For 2-wire RS485, connect pin 2 to pin 5 and pin 3 to pin 4 externally.

Table 23 X26/X27 Pinout Description

Pin	RS232	RS422/RS485	Description
1	GND	GND	Ground
2	TXD	TX-	Transmit Data/Transmit Data -
3	RTS#	TX+	Request to Send/Transmit Data +
4	CTS#	RX+	Clear to Send/Receive Data +
5	RXD	RX-	Receive Data/Receive Data -

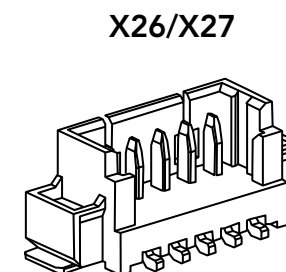
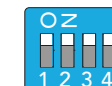

Table 24 DIP SW3 - COM Port Configuration

Switch	Configuration	Description
SW3.1	OFF	COM 0 RS422/RS485 standard
	ON	COM 0 RS232 standard (default)
SW3.2	OFF	COM 2 RS422/RS485 standard
	ON	COM 2 RS232 standard (default)

**SW3**







SW3.3	OFF	COM 0 RS485 standard with echo cancellation
	ON	COM 0 RS422 standard (default)
SW3.4	OFF	COM 2 RS485 standard with echo cancellation
	ON	COM 2 RS422 standard (default)

### Connector Type

X26,X27: 5-pin, 1.25 mm pitch picoblade header (Molex 0533980571)

Possible Mating Connector: Molex 0510210500

## 4.11.2 COM 1 and 3 (RS232)

The conga-SMC1 provides COM port 1 on pin header X28 and COM port 3 on pin header X29. Both ports support only RS 232 voltage level, without flow control.

Table 25 X28/X29 Pinout Description

Pin	Signal	Description
1	GND	Ground
2	TXD	Transmit data
3	N.C	Not connected
4	N.C	Not connected
5	RXD	Receive data

### Connector Type

X28,X29: 5-pin, 1.25 mm pitch picoblade header (Molex 0533980571)

Possible Mating Connector: Molex 0510210500

X28/X29

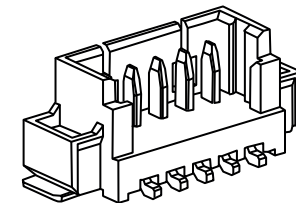



## 4.12 GPIO Header

The conga-SMC1 provides up to eight GPIOs on connector X37. All I/O signals have 1.8 V level. The 3.3V is provided through a 500mA resettable fuse.

Table 26 X37 Pinout Description

Pin	Signal	Description
1	GPIO4/N.C	General Purpose Input Output 4 on ARM-based variant (PN: 020750) Not connected on x86-based variant (PN: 020751)
2	GPIO12	General Purpose Input Output 12 Optional GPIO5/fan's PWM output
3	GPIO13	General Purpose Input Output 13 Optional GPIO6/fan's tachometer input
4	GPIO7	General Purpose Input Output 7
5	GND	Ground
6	GPIO8	General Purpose Input Output 8
7	GPIO9	General Purpose Input Output 9
8	GPIO10	General Purpose Input Output 10
9	GPIO11	General Purpose Input Output 11
10	+ 3.3 V	3.3 V supply (runtime)

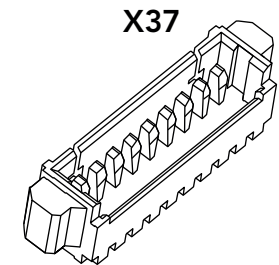

### Note

1. On x86 variant, pin 1 is not connected because GPIO4 is used for HD audio reset.
2. Pins 2 and 3 are for GPIO12 and GPIO13 respectively because we used GPIO5 and GPIO6 for fan control by default.

### Connector Type

X37: 10-pin, 1.25 mm pitch picoblade header (Molex 0532611071)

Possible Mating Connector: Molex 0510211000



## 4.13 I<sup>2</sup>C Bus/SM Bus Header

The conga-SMC1 provides header X30 for I<sup>2</sup>C/SM bus signals. All I/O signals have 1.8 V level. The 3.3 V is provided through a 500 mA resettable fuse.

Table 27 X30 Pinout Description

Pin	Signal	Description
1	N.C	Not connected
2	I2C_GP_DAT	General purpose I2C data
3	GND	Ground reference
4	I2C_GP_CK	General purpose I2C clock output
5	+3.3 V	+3.3 V runtime power output with 500 mA fuse
6	SMB_ALERT_1V8#	SMBus Alert signal from external device. Should be driven by open drain/collector output
7	I2C_PM_DAT/SMB_DAT	Power management I2C data or SM bus data on x86 variant
8	GND	Ground reference
9	I2C_PM_CK/SMB_CLK	Power management I2C clock output or SM bus clock output on x86 variant
10	+ 3.3 V	+3.3 V power output with 500 mA (standby)

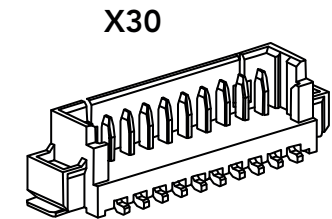

Use pin 5 (runtime power) for I2C devices and pin 10 (standby power) for I2C\_PM/SMBus devices.

### Connector Type

X30: 10-pin, 1.25 mm pitch picoblade header (Molex 0533981071)

Possible Mating Connector: Molex 0510211000

## 4.14 eSPI/SPI1 Header

The conga-SMC1 provides eSPI/SPI signals on connector CN1 for general purpose SPI add-on modules. All I/O signals have 1.8 V level.

Table 28 CN1 Pinout Description

Pin	Signal	Description	Pin	Signal	Description
1	GND	Ground	2	ESPI_CS0#	ESPI master chip select output for first eSPI device
3	ESPI_CK	ESPI master clock output	4	ESPI_IO3	ESPI master data input/output 3
5	Empty		6	ESPI_IO2	ESPI master data input/output 2

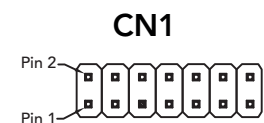



7	ESPI_RESET#	ESPI reset output	8	ESPI_IO1	ESPI master data input/output 1 Master input, slave output in single I/O mode
9	+V3.3S	3.3 V runtime power	10	ESPI_IO0	ESPI master data input/output 0 Master output, slave input in single I/O mode
11	ESPI_ALERT1#	ESPI open drain alert signal 1. The eSPI add-on module should use open drain output	12	ESPI_CS1#	ESPI master chip select output for second eSPI device
13	+V3.3A	3.3 V standby power	14	ESPI_ALERT0#	ESPI open drain alert signal 0. The eSPI add-on module should use an open drain output

### Connector Type

CN1: 2.54 mm, 2 x 7-pin header (without pin 5)

## 4.14.1 SPI Device Header

The conga-SMC1 provides connector X36 for external BIOS flash (boot from carrier SPI). With the SPI BIOS flash, you can evaluate a custom BIOS or load BIOS/bootloader default settings (recovery). However, you need an SPI flash with a PCB adapter that connects to X36. For more information, contact congatec support.

To select X36 as boot source, set DIP SW4.4 to ON position. For more information about boot selection, see section 4.15 “Boot Selection Switch”.

Table 29 X36 Pinout Description

Pin	Signal	Description	Pin	Signal	Description
1	SPIO_CS0#	SPI flash CS# pin	2	VDD	1.8 V power supply
3	SPIO_DIN	SPI flash input pin	4	SPIO_HOLD#	SPI flash HOLD# pin
5	SPIO_WP#	SPI flash WP# pin	6	SPIO_CLK	SPI clock input
7	GND	Ground	8	SPIO_DOOUT	SPI flash output pin
9	N.C	Not connected	10	N.C	Not connected by default

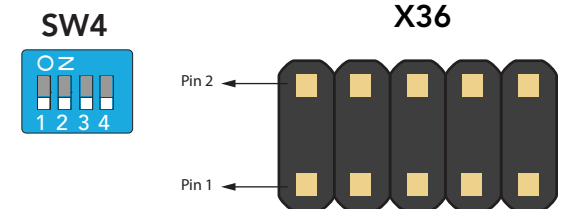

### Note

Use only 1.8 V SPI flash.

### Connector Type

X36: 1.27 mm, 2x5 pin female



## 4.15 Boot Selection Switch

Use DIP SW4.2–SW4.4 to select the BIOS or bootloader boot source as shown in the table below. Alternatively, connect an external switch to pins 1 and 2 of connector X59.

Table 30 DIP SW4 - Boot Source Configuration

Switch	Configuration	Description
SW4.2	OFF	Disable Boot select 0 (default)
	ON	Enable Boot select 0
SW4.3	OFF	Disable Boot select 1 (default)
	ON	Enable Boot select 1
SW4.4	OFF	Disable Boot select 2 (default)
	ON	Enable Boot select 2

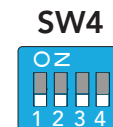

## 4.16 Force Recovery Switch

Use switch 1 of DIP SW4 or slide switch SW5 to operate the SMARC module in force recovery mode. Alternatively, connect an external switch to pins 1 and 2 of connector X59.

The green LED D96 lights when the force recovery mode is enabled. For more information about this mode, refer to the module's manual.

Table 31 DIP SW4.1 Configuration

Switch	Configuration	Description
SW4.1	OFF	Normal operation (default)
	ON	Force recovery mode

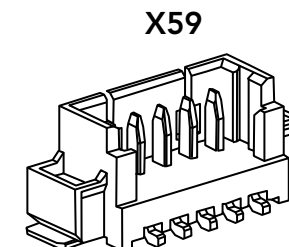
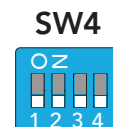
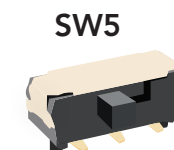

Table 32 Switch SW5 Configuration

Switch	Configuration	Description
SW5	1-2	Normal operation (default)
	2-3	Force recovery mode





## 4.17 Test Mode/Wireless-Disable Mode

On conga-SMC1, connector X59 provides the following functions:

- force recovery (see section 4.16 “Force Recovery Switch”)
- module-specific test function
- wireless-disable mode

To activate any of these functions, connect the corresponding signal at pins 1, 3 or 5 to GND (pins 2 or 4).

Table 33 X59 Pinout Description

Pin	Signal	Description
1	FORCE_RECOV#	Force recovery
2	GND	Ground
3	TEST#	Module-specific test function
4	GND	Ground
5	WDIS#	Wireless disable

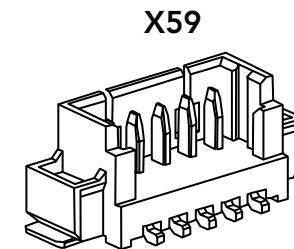

### Connector Type

X59: 5-pin, 1.25 mm pitch picoblade header (Molex 0532610571)

Possible Mating Connector: Molex 0510210500

## 4.18 CAN Bus Header

The conga-SMC1 provides two CAN buses—CAN 0 on connector X24 and CAN 1 on connector X25. The CAN buses do not have resistor termination. For CAN bus termination, use a cable adapter with internal resistor termination.

Additionally, connector X38 may be used for powering CAN devices or auxiliary fan.

Table 34 X24/X25 Pinout Description

X24 - CAN 0		X25 - CAN 1	
Pin	Signal	Pin	Signal
1	CAN0_H	1	CAN1_H
2	CAN0_L	2	CAN1_L
3	GND	3	GND

**X24/X25**

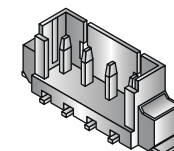
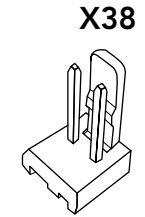



Table 35 X38 Pinout Description

Pin	Signal
1	GND
2	+12 VDC (500 mA fuse)



 **Connector Type**

X24,X25: 3-pin, 1.25 mm pitch PicoBlade header (Possible Mating Connector: Molex 0510210200)  
 X38: 2.54 mm pitch, 2-pin Molex 22272021 (Mating Connector: Molex 2695)

## 4.19 CPU Fan Header

The conga-SMC1 provides pin header X54 for connecting a 3-pin or 4-pin 12 V CPU fan. The recommended maximum power rating for the fan is 4W.

Table 36 X54 Pinout Description

Pin	Signal
1	GND
2	+12 VDC (500 mA fuse)
3	FAN_TACHOIN
4	FAN_CTRL

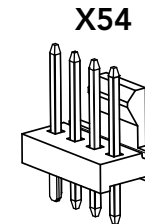

 **Note**

1. The connector and pinout complies with 4-Wire Pulse PWM Controlled Fans Specification, Revision 1.3
2. FAN\_TACHOIN fan output shall provide two pulses per revolution.
3. The fan must pull up the FAN\_CTRL signal to high logic level

 **Connector Type**

X54: 2.54 mm, 4-pin grid female fan connector



## 4.20 Front Panel Header

The conga-SMC1 provides X32 for front panel features such as lid switch, sleep, reset and power buttons, as well as status LEDs.

Table 37 X32 Pinout Description

Pin	Signal Name	Description
1	LID#	Triggers sleep, hibernation, shutdown or wake state (system behavior depends on ACPI settings of the OS)
2	GND	Ground
3	SLEEP#	Triggers sleep or hibernation state (system behavior depends on ACPI settings of the Operating System)
4	GND	Ground
5	RESET_IN#	Triggers hard reset (system behavior depends on ACPI settings of the Operating System)
6	GND	Ground
7	POWER_BTN#	Triggers power-up sequence, active on rising edge
8	GND	Ground
9	PWR_LED (anode)	LED indicates the system is running (Note: pin 9 has an onboard series resistor)
10	GND (cathode)	Main color (runtime state (S0)): pin 9 for anode and pin 10 for cathode
11	SATA_LED (anode)	LED indicates activity on the SATA connector X5
12	SATA_ACT# (cathode)	(onboard series resistor makes it possible to connect the LEDs directly to the pins)

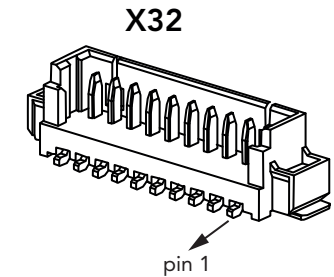

### Connector Type

X32: 12-pin, 1.25 mm pitch (Molex 53398-1271)

Possible Mating Connector: Molex 0510211200





## 4.21 Feature Connector

The conga-SMC1 provides X31 for management and miscellaneous signals.

Table 38 X31 Pinout Description

Pin	Signal Name	I/O Level	Description
1	CARRIER_STBY#	1.8 V	Input signal that indicates the system is in suspend state (active low)
2	RESET_OUT#	1.8 V	System reset output (for external active devices)
3	BATLOW#	1.8 V to 5 V	Input signal that indicates the external battery is low Note: Connect to open-drain output
4	WDT_TIME_OUT#	1.8 V	Watchdog timer output (driven only during runtime)
5	GND		Ground
6	GBE0_SDP	3.3 V	Output signals for hardware implementation of Precision Time Protocol (PTP)
7	GBE1_SDP		
8	CHARGING#	1.8 V to 5 V	Input signal that is held low when the battery is charging Note: Connect to open-drain output
9	CHARGER_PRSENT#	1.8 V to 5 V	Input signal that indicates the presence of a battery charger. Note: Connect to open-drain output
10	VCC	3.3 V	Power source

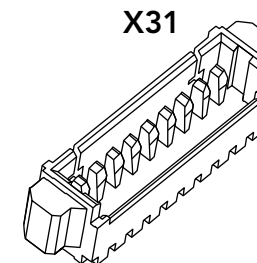

### Connector Type

X31: 10-pin, 1.25 mm pitch picoblade header (Molex 0532611071)

Possible Mating Connector: Molex 0510211000



# 5 Additional Features

## 5.1 Buttons

The conga-SMC1 features an onboard power button M12. The SMARC module starts when you press the power-on button M12. The other button signals—power, reset and sleep buttons as well as LID and LED signals are available via the front panel header X32.

**M12**

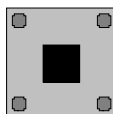

### Note

*The conga-SMC1 offers an optional right-angle button (BOM option)*

## 5.2 Debug Feature—Internal Use Only

The conga-SMC1 provides a JTAG interface via test points TP7-TP10. This interface is used for programming and debugging the congatec board controller (internal use only). Use switch 1 of DIP SW6 to enable test mode.

**Table 39** DIP SW6.1 - Test Mode Selection

Switch	Configuration	Description
SW6.1	OFF	Disable test mode
	ON	Enable test mode

**SW6**

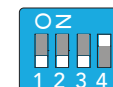



# 6 Mechanical Dimensions

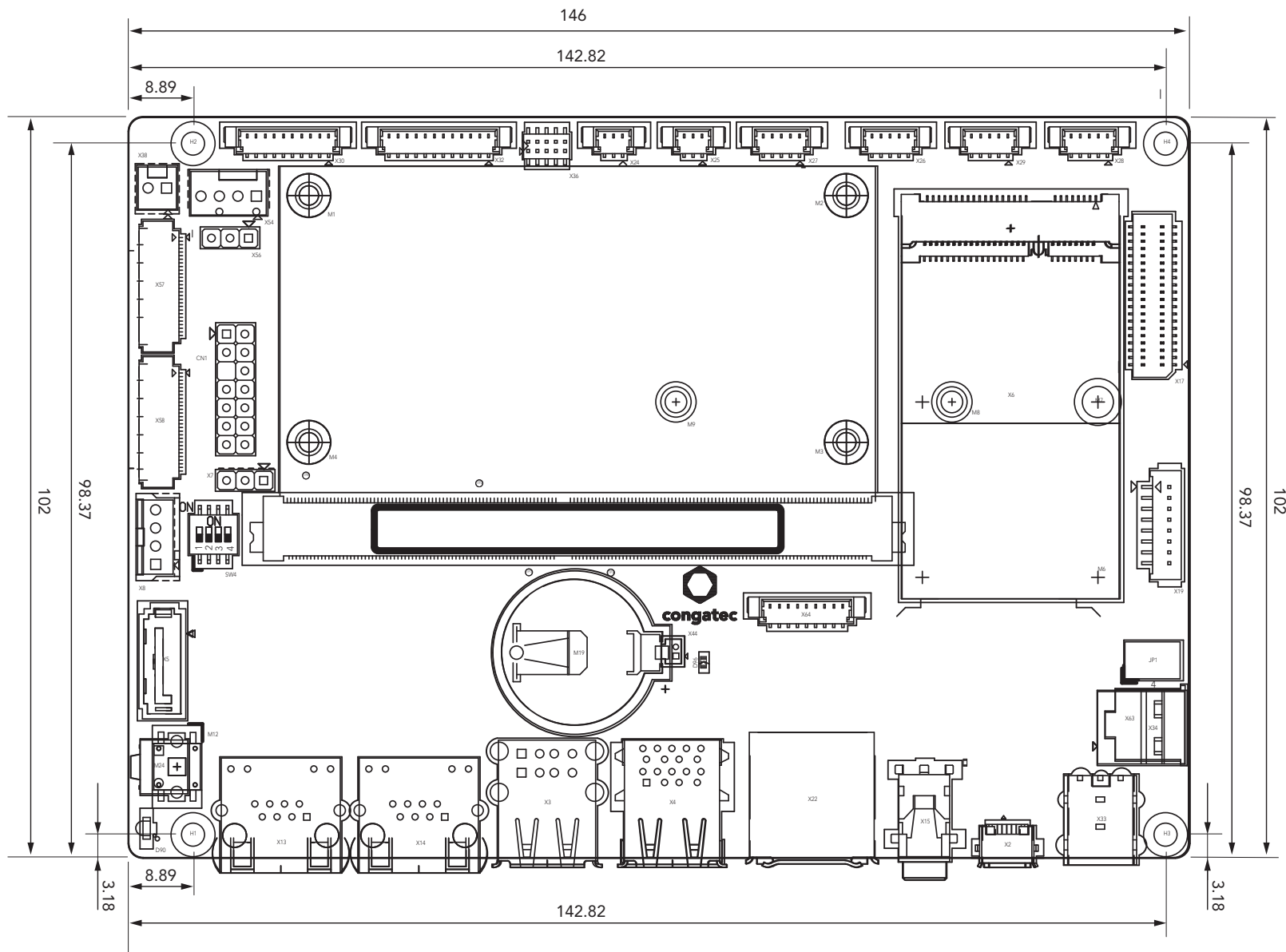

All dimensions are in millimeters.