



SPECIFICATION



TCG104VGLACANN-AN00
10.4" - VGA - LVDS

Version: 0.0
Date: 19.03.2015

Note: This specification is subject to change without prior notice

www.data-modul.com

SPEC

| | |
|----------|-----------------------|
| Spec No. | TQ3C-8EAF0-E1YAG41-00 |
| Date | March 19, 2015 |

TYPE : TCG104VGLACANN-AN00

< 10.4 inch VGA transmissive color TFT with LED backlight >

CONTENTS

1. Application
2. Construction and outline
3. Mechanical specifications
4. Absolute maximum ratings
5. Electrical characteristics
6. Optical characteristics
7. Interface signals
8. Input timing characteristics
9. Lot number identification
10. Warranty
11. Precautions for use
12. Reliability test data
13. Outline drawing



KYOCERA DISPLAY CORPORATION

This specification is subject to change without notice.
Consult Kyocera before ordering.

| Original Issue Date | Designed by: Engineering dept. | | | Confirmed by: QA dept. | |
|---------------------|--------------------------------|-------------|----------|------------------------|-----------|
| | Prepared | Checked | Approved | Checked | Approved |
| March 19, 2015 | M. Koyama | Y. Yamazaki | W. Yano | O. Sato | I. Hamada |

| | | |
|-----------------------------------|---------------------------------|-----------|
| Spec No. TQ3C-8EAF0-E1YAG41-00 | Part No. TCG104VGLACANN-AN00 | Page - |
|-----------------------------------|---------------------------------|-----------|

Warning

1. This Kyocera LCD module has been specifically designed for use only in electronic devices and industrial machines in the area of audio control, office automation, industrial control, home appliances, etc. The module should not be used in applications where the highest level of safety and reliability are required and module failure or malfunction of such module results in physical harm or loss of life, as well as enormous damage or loss. Such fields of applications include, without limitation, medical, aerospace, communications infrastructure, atomic energy control. Kyocera expressly disclaims any and all liability resulting in any way to the use of the module in such applications.

2. Customer agrees to indemnify, defend and hold Kyocera harmless from and against any and all actions, claims, damages, liabilities, awards, costs, and expenses, including legal expenses, resulting from or arising out of Customer's use, or sale for use, or Kyocera modules in applications.

Caution

1. Kyocera shall have the right, which Customer hereby acknowledges, to immediately scrap or destroy tooling for Kyocera modules for which no Purchase Orders have been received from the Customer in a two-year period.

| | | |
|-----------------------------------|---------------------------------|-----------|
| Spec No. TQ3C-8EAF0-E1YAG41-00 | Part No. TCG104VGLACANN-AN00 | Page - |
|-----------------------------------|---------------------------------|-----------|

Revision record

| Date | | Designed by : Engineering dept. | | | Confirmed by : QA dept. | |
|---------|------|---------------------------------|--------------|----------|-------------------------|----------|
| | | Prepared | Checked | Approved | Checked | Approved |
| | | | | | | |
| Rev.No. | Date | Page | Descriptions | | | |
| | | | | | | |

1. Application

This document defines the specification of TCG104VGLACANN-AN00. (RoHS Compliant)

2. Construction and outline

| | |
|--------------------|---|
| LCD | : Transmissive color dot matrix type TFT |
| Backlight system | : LED |
| Polarizer | : Anti-Glare treatment |
| Additional circuit | : Timing controller, Power supply (3.3V input) (with constant current circuit for LED Backlight) |

3. Mechanical specifications

| Item | Specification | Unit |
|-----------------------|---|------|
| Outline dimensions 1) | 230(W)×180.2(H)×(10.5)(D) | mm |
| Active area | 211.2(W)×158.4(H) (26.4cm/10.4 inch(Diagonal)) | mm |
| Dot format | 640×(R,G,B)(W)×480(H) | dot |
| Dot pitch | 0.11(W)×0.33(H) | mm |
| Base color 2) | Normally White | - |
| Mass | 500 | g |

1) Projection not included. Please refer to outline for details.

2) Due to the characteristics of the LCD material, the color varies with environmental temperature.

4. Absolute maximum ratings

4-1. Electrical absolute maximum ratings

| Item | Symbol | Min. | Max. | Unit | |
|-----------------------|-----------------|-----------------|------|---------|---|
| Supply voltage(+3.3V) | V _{DD} | 0 | 4.0 | V | |
| Supply voltage(+24V) | V _{IN} | -0.3 | 26 | V | |
| Input signal voltage | 1) | V _{I1} | -0.3 | VDD+0.3 | V |
| | 2) | V _{I2} | -0.3 | VDD+0.3 | V |
| | 3) | V _{I3} | -0.3 | 14 | V |

- 1) SC
- 2) RxIN0-/+, RxIN1-/+, RxIN2-/+, RxIN3-/+, CK IN-/+, BLBRT, BLEN

4-2. Environmental absolute maximum ratings

| Item | Symbol | Min. | Max. | Unit |
|--------------------------|------------------|------|------|------|
| Operating temperature 1) | T _{OP} | -20 | 70 | °C |
| Storage temperature 2) | T _{STO} | -30 | 80 | °C |
| Operating humidity 3) | H _{OP} | 10 | 4) | %RH |
| Storage humidity 3) | H _{STO} | 10 | 4) | %RH |
| Vibration | - | 5) | 5) | - |
| Shock | - | 6) | 6) | - |

- 1) Operating temperature means a temperature which operation shall be guaranteed. Since display performance is evaluated at 25°C, another temperature range should be confirmed.
- 2) Temp. = -30°C < 48h , Temp. = 80°C < 168h
Store LCD at normal temperature/humidity. Keep them free from vibration and shock.
An LCD that is kept at a low or a high temperature for a long time can be defective due to other conditions, even if the low or high temperature satisfies the standard.
(Please refer to “Precautions for Use” for details.)
- 3) Non-condensing
- 4) Temp. ≤ 40°C, 85%RH Max.
Temp. > 40°C, Absolute humidity shall be less than 85%RH at 40°C.
- 5)

| | | |
|-----------------|-------------|---|
| Frequency | 10~55 Hz | Acceleration value (0.3~9 m/s ²) |
| Vibration width | 0.15mm | |
| Interval | 10-55-10 Hz | 1 minutes |

2 hours in each direction X, Y, Z (6 hours total)

EIAJ ED-2531

- 6) Acceleration: 490 m/s², Pulse width: 11 ms
3 times in each direction: ±X, ±Y, ±Z
EIAJ ED-2531

5. Electrical characteristics

5-1. LCD

Temp. = -20~70°C

| Item | Symbol | Condition | Min. | Typ. | Max. | Unit |
|---|------------------|-----------------------|---------------------|------|--------------------------|-------|
| Supply voltage 1) | V _{DD} | - | 3.0 | 3.3 | 3.6 | V |
| Current consumption | I _{DD} | 2) | - | 170 | 220 | mA |
| Permissive input ripple voltage | V _{RP} | V _{DD} =3.3V | - | - | 100 | mVp-p |
| Input signal voltage 3) | V _{IL} | "Low" level | 0 | - | 0.2V _{DD} | V |
| | V _{IH} | "High" level | 0.8V _{DD} | - | V _{DD} | V |
| Input reek current 3) | I _{OL} | V _{I3} =0V | -10 | - | 10 | μA |
| | I _{OH} | V _{I3} =3.3V | - | - | 350 | μA |
| Differential input voltage 4) | V _{ID} | - | 100 | - | 600 | mV |
| Differential input threshold voltage 4) | V _{TL} | "Low" level | -100 | - | - | mV |
| | V _{TH} | "High" level | - | - | 100 | mV |
| LVDS Common mode voltage 4) | V _{ICM} | | V _{ID} /2 | 1.2 | 2.4- V _{ID} /2 | |
| Terminator | R ₁ | - | - | 100 | - | Ω |

1) V_{DD}-turn-on conditions

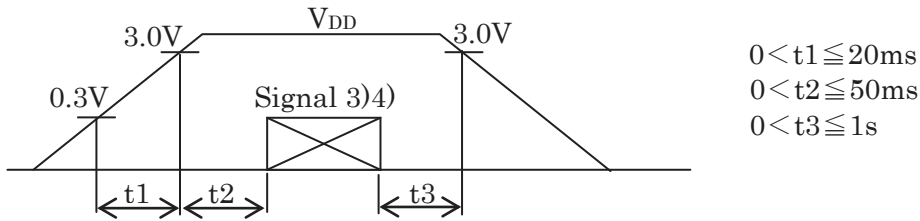

2) Display pattern:

V_{DD} = 3.3V, Temp. = 25°C

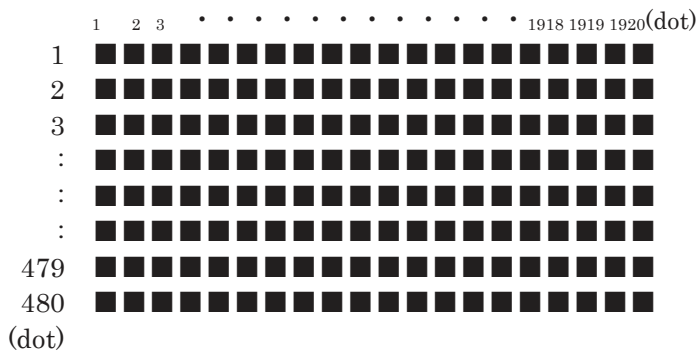

3) Input signal : SC

- 4) Input signal : RxIN3+, RxIN3-, RxIN2+, RxIN2-, RxIN1+, RxIN1-, RxIN0+, RxIN0-
CK IN+, CK IN-

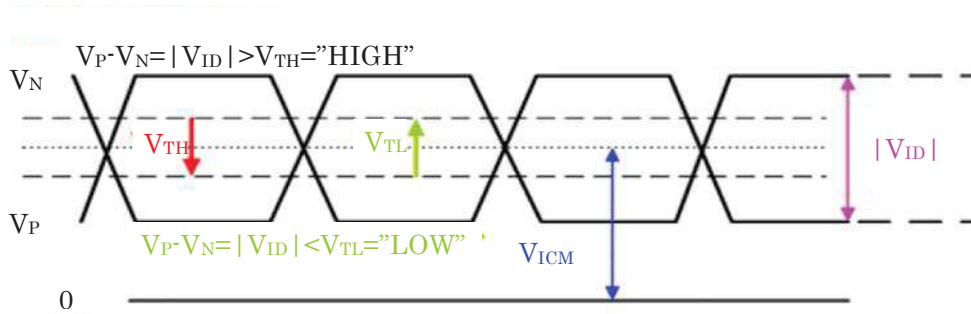

5-2. Constant current circuit for LED Backlight

Temp. = -20~70°C

| Item | Symbol | Condition | Min. | Typ. | Max. | Unit |
|----------------------------------|-----------------|-----------------|------|--------|------|-------|
| Supply voltage | 1) V_{IN} | - | 22.8 | 24.0 | 25.2 | V |
| Current consumption | I_{IN} | 2) | - | 310 | 410 | mA |
| Permissible input ripple voltage | V_{RP_BL} | $V_{IN}=24.0V$ | - | - | 100 | mVp-p |
| BLBRT Input signal voltage | V_{IL_BLBRT} | "Low" level | 0 | - | 0.8 | V |
| | V_{IH_BLBRT} | "High" level | 2.3 | - | 13.2 | V |
| BLBRT Input pull-up resistance | R_{IN_BLBRT} | $V_{IN}=24.0V$ | - | 10 | - | kΩ |
| | | $V_{IN}=0V$ | - | 1.6 | - | kΩ |
| BLEN Input signal voltage | V_{IL_BLEN} | "Low" level | 0 | - | 0.8 | V |
| | V_{IH_BLEN} | "High" level | 2.3 | - | 13.2 | V |
| BLEN Input pull-up resistance | R_{IN_BLEN} | $V_{IN}=24.0V$ | - | 10 | - | kΩ |
| | | $V_{IN}=0V$ | - | 1.6 | - | kΩ |
| PWM Frequency | 3) f_{PWM} | - | 200 | - | 10k | Hz |
| PWM Duty ratio | 3) D_{PWM} | $f_{PWM}=200Hz$ | 1 | - | 100 | % |
| | | $f_{PWM}=2kHz$ | 10 | - | 100 | % |
| | | $f_{PWM}=10kHz$ | 50 | - | 100 | % |
| Operating life time | 4), 5) T | Temp.=25° C | - | 70,000 | - | h |
| | | Temp.=70° C | - | 53,000 | - | h |

1) V_{IN} -turn-on conditions

2) $V_{IN} = 24V$, Temp. = 25°C, $D_{PWM} = 100\%$

3) PWM Timing Diagram

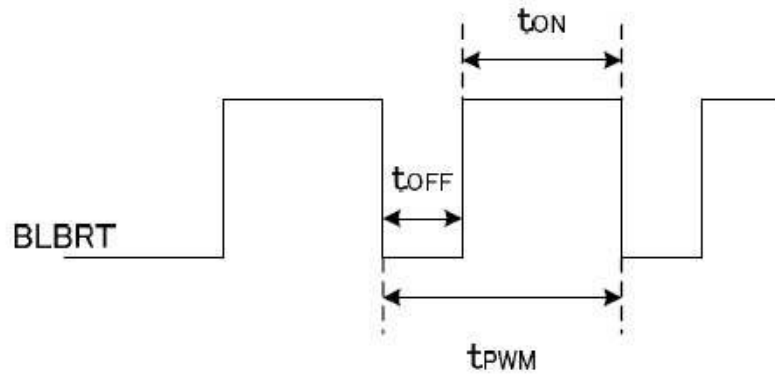

$t_{ON}, t_{OFF} \geq 50 \mu s$.

In case of lower frequency, the deterioration of the display quality, flicker etc., may occur.

- 4) When brightness decrease 50% of minimum brightness.
The average life of a LED will decrease when the LCD is operating at higher temperatures.
- 5) Life time is estimated data.(Condition : $I_F=15mA$, $T_a=25^\circ C$ in chamber).

6. Optical characteristics

Measuring spot = ϕ 6.0mm, Temp. = 25°C

| Item | Symbol | Condition | Min. | Typ. | Max. | Unit | |
|--|----------------|----------------------------|---------------------------|-------|-------|-------------------|----|
| Response time | Rise | τ_r | $\theta = \phi = 0^\circ$ | - | 10 | - | ms |
| | Down | τ_d | $\theta = \phi = 0^\circ$ | - | 20 | - | ms |
| Viewing angle range View direction : 6 o'clock (Gray inversion) | θ UPPER | CR \geq 10 | - | 60 | - | deg. | |
| | θ LOWER | | - | 70 | - | | |
| | ϕ LEFT | | - | 70 | - | deg. | |
| | ϕ RIGHT | | - | 70 | - | | |
| Contrast ratio | CR | $\theta = \phi = 0^\circ$ | 350 | 500 | - | - | |
| Brightness | L | IF=70mA/Line Temp.=25°C | 1,050 | 1,500 | - | cd/m ² | |
| | | IF=70mA/Line Temp.=70°C | 840 | 1,200 | - | cd/m ² | |
| Chromaticity coordinates | Red | x | $\theta = \phi = 0^\circ$ | 0.556 | 0.606 | 0.656 | - |
| | | y | | 0.289 | 0.339 | 0.389 | |
| | Green | x | $\theta = \phi = 0^\circ$ | 0.286 | 0.336 | 0.386 | |
| | | y | | 0.503 | 0.553 | 0.603 | |
| | Blue | x | $\theta = \phi = 0^\circ$ | 0.102 | 0.152 | 0.202 | |
| | | y | | 0.067 | 0.117 | 0.167 | |
| | White | x | $\theta = \phi = 0^\circ$ | 0.256 | 0.306 | 0.356 | |
| | | y | | 0.281 | 0.331 | 0.381 | |

6-1. Definition of contrast ratio

$$\text{CR(Contrast ratio)} = \frac{\text{Brightness with all pixels "White"}}{\text{Brightness with all pixels "Black"}}$$

6-2. Definition of response time

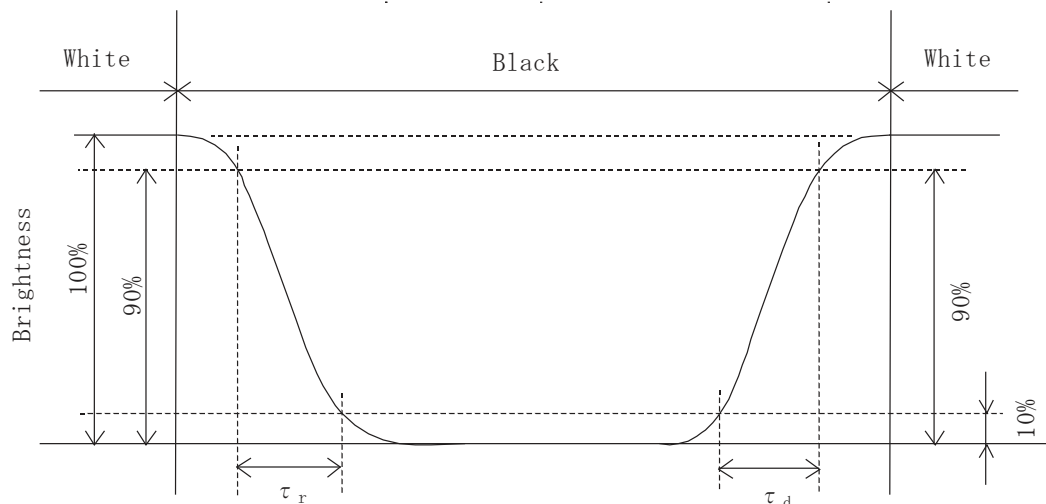

6-3. Definition of viewing angle

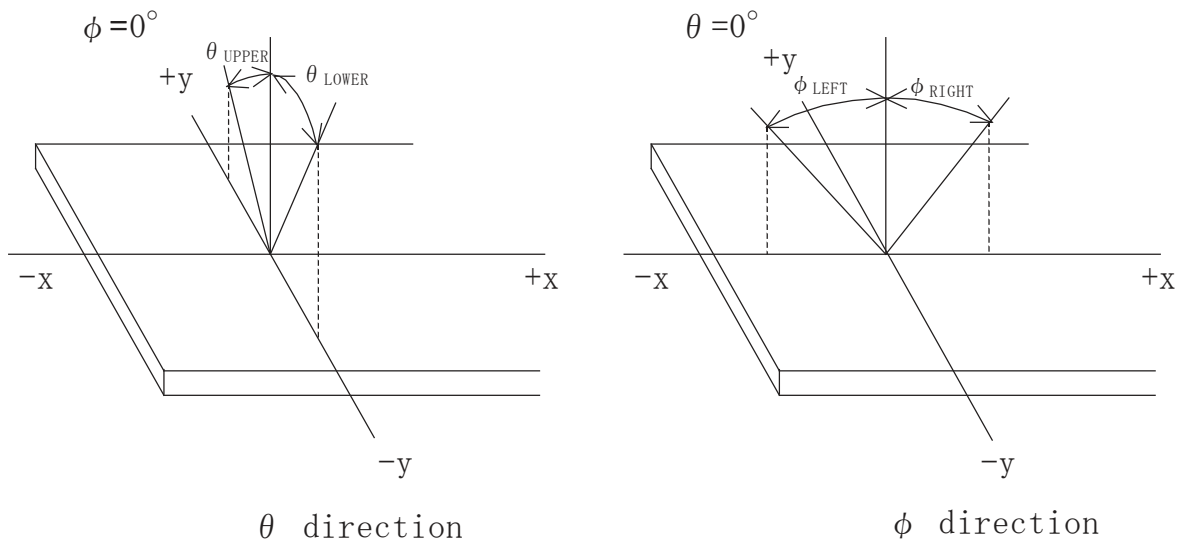

6-4. Brightness measuring points

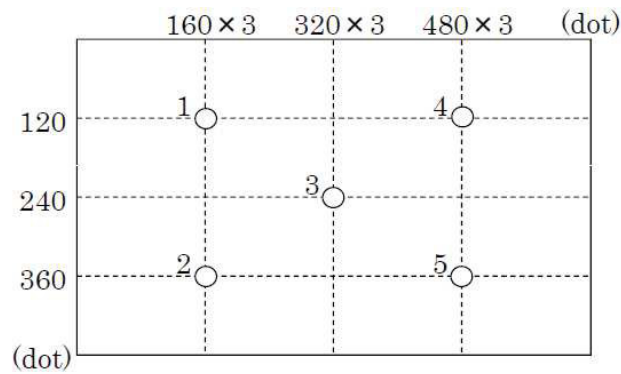

- 1) Rating is defined as the white brightness at center of display screen(3).
- 2) 5 minutes after LED is turned on. (Ambient Temp.=25°C)

7. Interface signals

7-1. Interface signals

| No. | Symbol | Description | Note |
|-----|-----------------|--|------|
| 1 | V _{DD} | +3.3V power supply | |
| 2 | V _{DD} | +3.3V power supply | |
| 3 | GND | GND | |
| 4 | GND | GND | |
| 5 | RxIN0- | LVDS receiver signal CH0(-) | LVDS |
| 6 | RxIN0+ | LVDS receiver signal CH0(+) | LVDS |
| 7 | GND | GND | |
| 8 | RxIN1- | LVDS receiver signal CH1(-) | LVDS |
| 9 | RxIN1+ | LVDS receiver signal CH1(+) | LVDS |
| 10 | GND | GND | |
| 11 | RxIN2- | LVDS receiver signal CH2(-) | LVDS |
| 12 | RxIN2+ | LVDS receiver signal CH2(+) | LVDS |
| 13 | GND | GND | |
| 14 | CK IN1- | LVDS receiver signal CK(-) | LVDS |
| 15 | CK IN1+ | LVDS receiver signal CK(+) | LVDS |
| 16 | GND | GND | |
| 17 | RxIN3- | LVDS receiver signal CH3(-) | LVDS |
| 18 | RxIN3+ | LVDS receiver signal CH3(+) | LVDS |
| 19 | NC | No Connect | 1) |
| 20 | SC | Scan direction control(GND: Normal、 High: Reverse) | 2) |

LCD connector : FI-SE20P-HFE (JAE)

1) Pin 19 is not connected to the internal display circuits. A connection on this pin will not impact the module operation in any way.

2)



SC = L



SC = H

7-2. LED

| No. | Symbol | Description | Note |
|-----|-----------------|-----------------------------------|------|
| 1 | V _{IN} | +24V power supply | |
| 2 | V _{IN} | +24V power supply | |
| 3 | BLBRT | PWM signal(Brightness adjustment) | |
| 4 | BLEN | ON/OFF terminal voltage | |
| 5 | GND | GND | |
| 6 | GND | GND | |
| 7 | GND | GND | |
| 8 | GND | GND | |
| 9 | V _{IN} | +24V power supply | |
| 10 | V _{IN} | +24V power supply | |

LCD connector : FI-S10P-HFE (JAE)

8. Input timing characteristics

8-1. Timing Characteristics

| Item | | Symbol | Min. | Typ. | Max. | Unit | Note |
|--------------------|---------------------------|--------|-------|------|-------|---------|------|
| Clock (CK) | Frequency | 1/Tc | 22.66 | 25.2 | 27.69 | MHz | |
| Enable signal (DE) | Horizontal Period | Th | 750 | 800 | 850 | Tc | |
| | | | 27.1 | 31.7 | - | μs | 1) |
| | Horizontal display period | Thd | 640 | | | Tc | |
| | Vertical Period | Tv | 490 | 525 | 590 | Th | |
| | Vertical display period | Tvd | 480 | | | Th | |
| Refresh rate | | fv | 50 | 60 | 70 | Hz | 2) |

1) Please set a clock frequency, a vertical dormant period, and the horizontal dormant period so that the Horizontal Period should not reach less than Min. value.

2) If the refresh rate reach less than Min. value, the deterioration of the display quality, flicker etc., may occur. ($fv=1/Tv$)

Vertical Timing Diagram

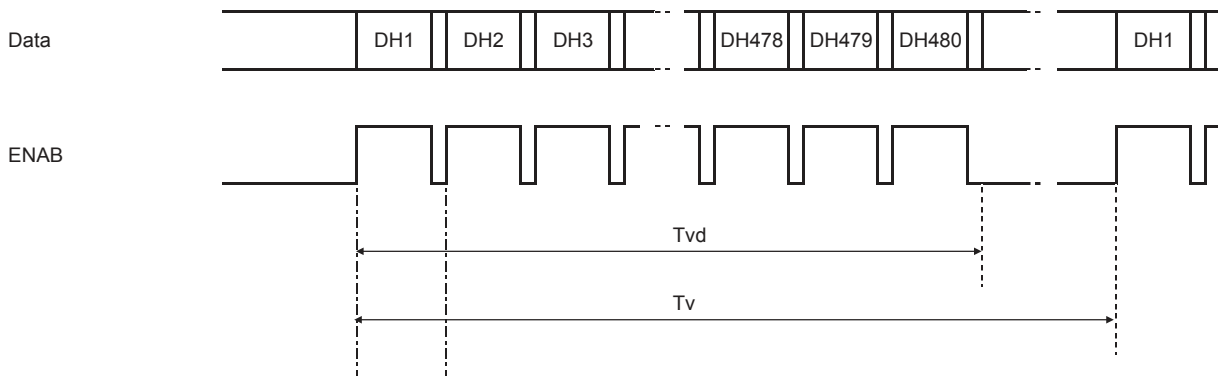

Horizontal Timing Diagram

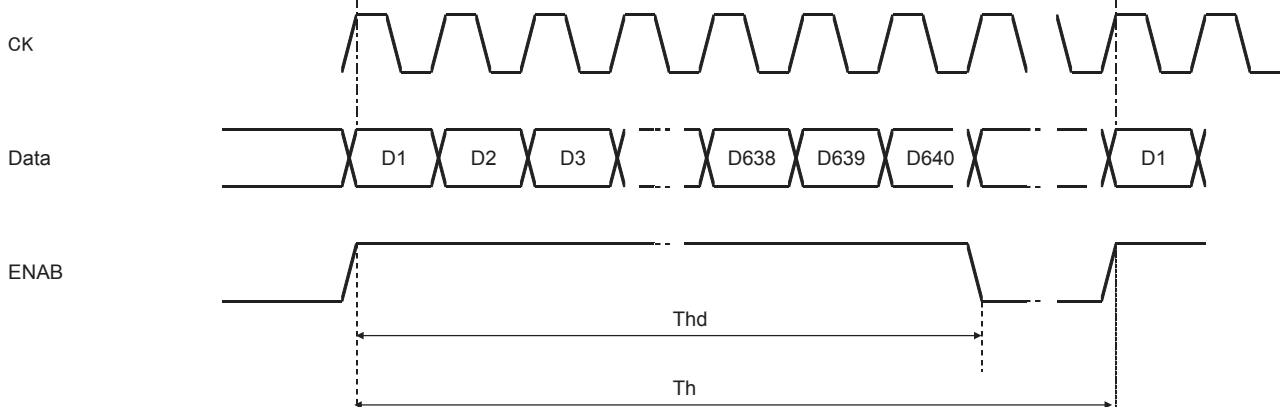

8-2. Data
8-2-1.8bit Input

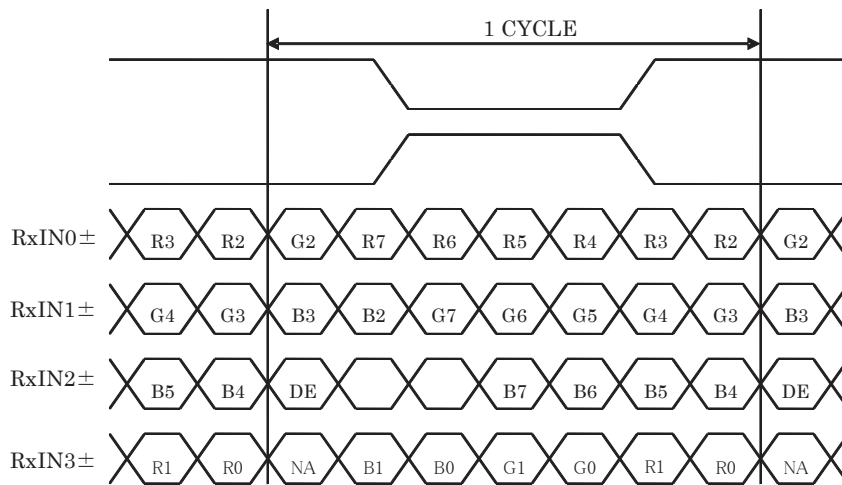

8-2-2.6bit Input

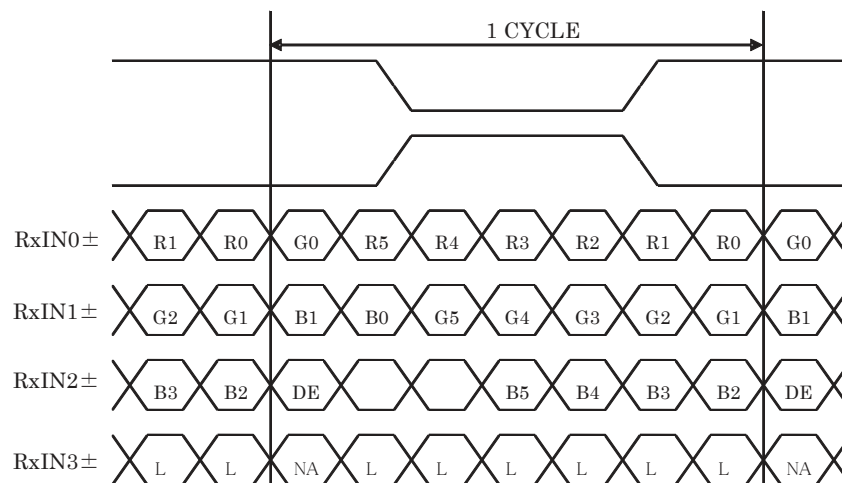

8-3. Input Data Signals and Display position on the screen

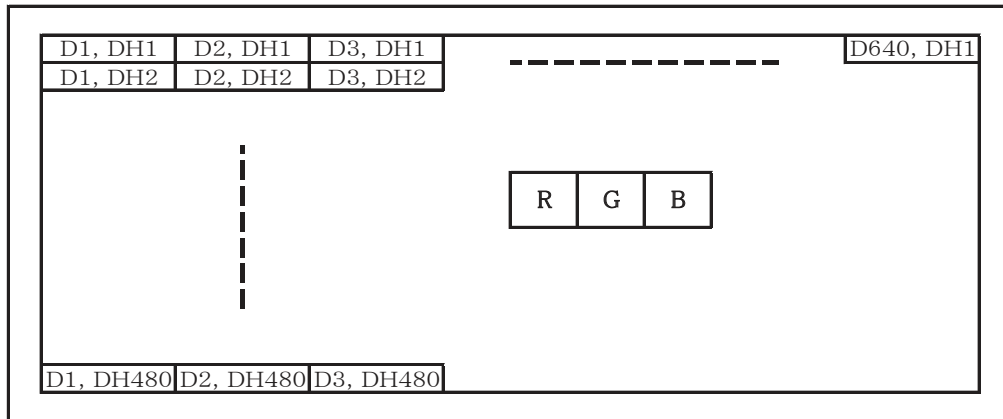

9. Lot number identification

The lot number shall be indicated on the back of the backlight case of each LCD.

TCG104VGLACANN-AN00 - □□ - □□ - □ MADE IN □□□□□
 ↓ ↓ ↓ ↓ ↓
 1 2 3 4 5

- No1. - No5. above indicate
1. Year code
 2. Month code
 3. Date
 4. Version Number
 5. Country of origin (Japan or China)

| | | | | | | |
|------|------|------|------|------|------|------|
| Year | 2015 | 2016 | 2017 | 2018 | 2019 | 2020 |
| Code | 5 | 6 | 7 | 8 | 9 | 0 |

| | | | | | | |
|-------|------|------|------|------|-----|------|
| Month | Jan. | Feb. | Mar. | Apr. | May | Jun. |
| Code | 1 | 2 | 3 | 4 | 5 | 6 |

| | | | | | | |
|-------|------|------|------|------|------|------|
| Month | Jul. | Aug. | Sep. | Oct. | Nov. | Dec. |
| Code | 7 | 8 | 9 | X | Y | Z |

| | | |
|-----------------------------------|---------------------------------|------------|
| Spec No. TQ3C-8EAF0-E1YAG41-00 | Part No. TCG104VGLACANN-AN00 | Page 12 |
|-----------------------------------|---------------------------------|------------|

10. Warranty

10-1. Incoming inspection

Please inspect the LCD within one month after your receipt.

10-2. Production warranty

Kyocera warrants its LCD's for a period of 12 months from the ship date. Kyocera shall, by mutual agreement, replace or re-work defective LCD's that are shown to be Kyocera's responsibility.

| | | |
|-----------------------------------|---------------------------------|------------|
| Spec No. TQ3C-8EAF0-E1YAG41-00 | Part No. TCG104VGLACANN-AN00 | Page 13 |
|-----------------------------------|---------------------------------|------------|

11. Precautions for use

11-1. Installation of the LCD

- 1) A transparent protection plate shall be added to protect the LCD and its polarizer
- 2) The LCD shall be installed so that there is no pressure on the LSI chips.
- 3) The LCD shall be installed flat, without twisting or bending.
- 4) A transparent protection sheet is attached to the polarizer. Please remove the protection film slowly before use, paying attention to static electricity.

11-2. Static electricity

- 1) Since CMOS ICs are mounted directly onto the LCD glass, protection from static electricity is required.
- 2) Workers should use body grounding. Operator should wear ground straps.

11-3. LCD operation

- 1) The LCD shall be operated within the limits specified. Operation at values outside of these limits may shorten life, and/or harm display images.
- 2) Please select the best display pattern based on your evaluation because flicker, lines or nonuniformity or unevenness can be visible depending on display patterns.

11-4. Storage

- 1) The LCD shall be stored within the temperature and humidity limits specified.
Store in a dark area, and protect the LCD from direct sunlight or fluorescent light.
- 2) Always store the LCD so that it is free from external pressure onto it.

11-5. Usage

- 1) **DO NOT** store in a high humidity environment for extended periods. Polarizer degradation bubbles, and/or peeling off of the polarizer may result.
- 2) The front polarizer is easily scratched or damaged. Prevent touching it with any hard material, and from being pushed or rubbed.
- 3) The LCD screen may be cleaned by wiping the screen surface with a soft cloth or cotton pad using a little Ethanol.
- 4) Water may cause damage or discoloration of the polarizer. Clean condensation or moisture from any source immediately.
- 5) Always keep the LCD free from condensation during testing. Condensation may permanently spot or stain the polarizer.
- 6) Do not disassemble LCD because it will result in damage.
- 7) This Kyocera LCD has been specifically designed for use in general electronic devices, but not for use in a special environment such as usage in an active gas. Hence, when the LCD is supposed to be used in a special environment, evaluate the LCD thoroughly beforehand and do not expose the LCD to chemicals such as an active gas.
- 8) Please do not use solid-base image pattern for long hours because a temporary afterimage may appear. We recommend using screen saver etc. in cases where a solid-base image pattern must be used.
- 9) Liquid crystal may leak when the LCD is broken. Be careful not to let the fluid go into your eyes and mouth. In the case the fluid touches your body; rinse it off right away with water and soap.

12. Reliability test data

| Test item | Test condition | Test time | Judgement |
|--------------------------------|--------------------------------------|-----------|--|
| High temp. atmosphere | 80°C | 240h | Display function : No defect Display quality : No defect Current consumption : No defect |
| Low temp. atmosphere | -30°C | 240h | Display function : No defect Display quality : No defect Current consumption : No defect |
| High temp. humidity atmosphere | 40°C 90% RH | 240h | Display function : No defect Display quality : No defect Current consumption : No defect |
| Temp. cycle | -30°C 0.5h R.T. 0.5h 80°C 0.5h | 10cycles | Display function : No defect Display quality : No defect Current consumption : No defect |
| High temp. operation | 70°C | 500h | Display function : No defect Display quality : No defect Current consumption : No defect |

- 1) Each test item uses a test LCD only once. The tested LCD is not used in any other tests.
- 2) The LCD is tested in circumstances in which there is no condensation.
- 3) The reliability test is not an out-going inspection.
- 4) The result of the reliability test is for your reference purpose only.
The reliability test is conducted only to examine the LCD's capability.

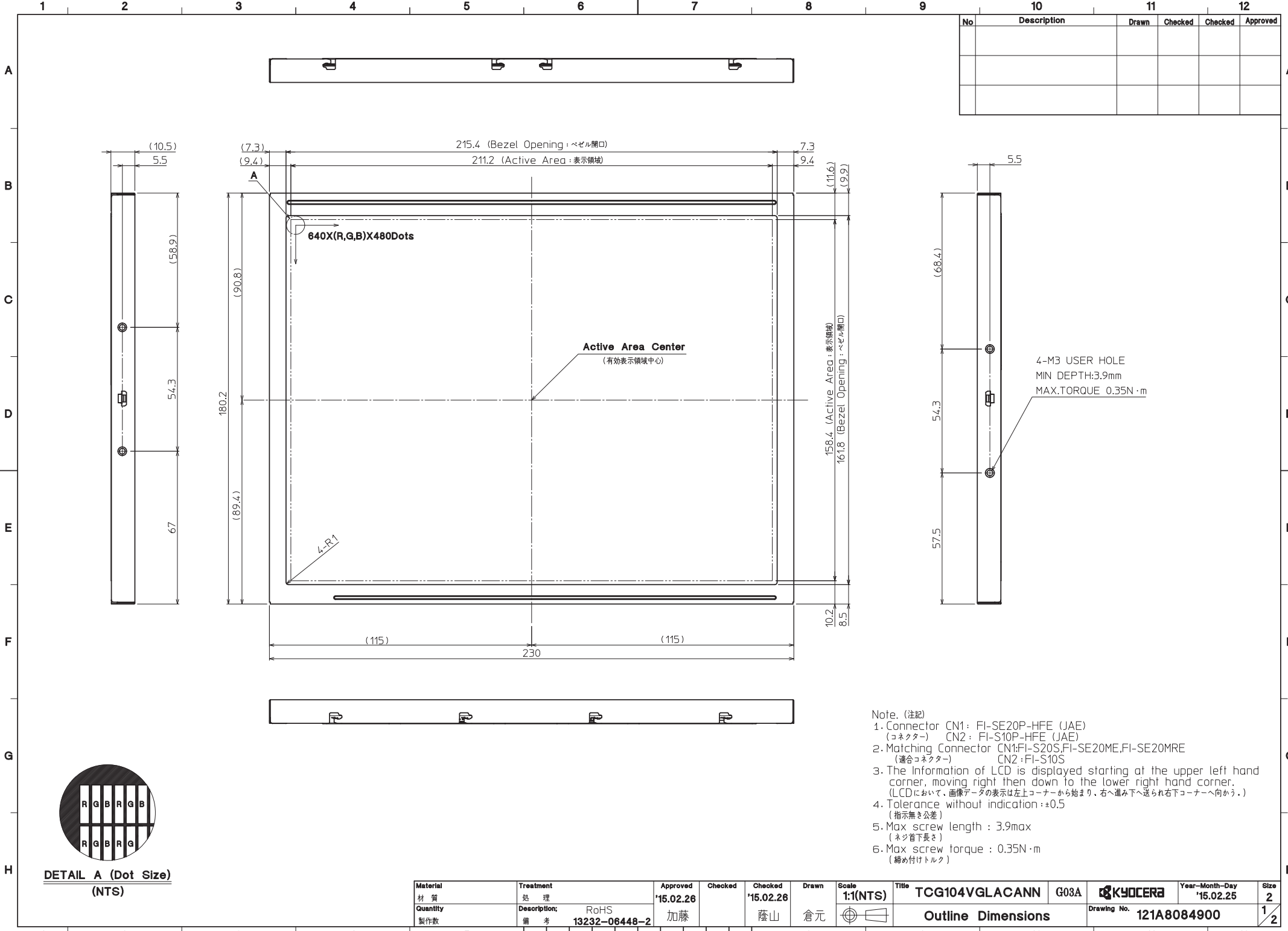

| No | Description | Drawn | Checked | Checked | Approved |
|----|-------------|-------|---------|---------|----------|
| | | | | | |
| | | | | | |

- Note. (注記)
- Connector CN1: FI-SE20P-HFE (JAE)
(コネクタ) CN2: FI-S10P-HFE (JAE)
 - Matching Connector CN1:FI-S20S,FI-SE20ME,FI-SE20MRE
(適合コネクタ) CN2:FI-S10S
 - The Information of LCD is displayed starting at the upper left hand corner, moving right then down to the lower right hand corner.
(LCDにおいて、画像データの表示は左上コーナーから始まり、右へ進み下へ送られ右下コーナーへ向かう。)
 - Tolerance without indication : ±0.5
(指示無き公差)
 - Max screw length : 3.9max
(ネジ首下長さ)
 - Max screw torque : 0.35N·m
(締め付けトルク)





DETAIL A (Dot Size)
(NTS)

| | | | | | | | | | |
|-----------------|--|-----------------------|---------|----------------------|-------------|-------------------|------------------------------|-----------------------------|-----------|
| Material 材質 | Treatment 処理 | Approved '15.02.26 | Checked | Checked '15.02.26 | Drawn 倉元 | Scale 1:1(NTS) | Title TCG104VGLACANN G03A | Year-Month-Day '15.02.25 | Size 2 |
| Quantity 製作数 | Description 備考 RoHS 13232-06448-2 | 加藤 | | 蔭山 | | | Outline Dimensions | Drawing No. 121A8084900 | 1/2 |

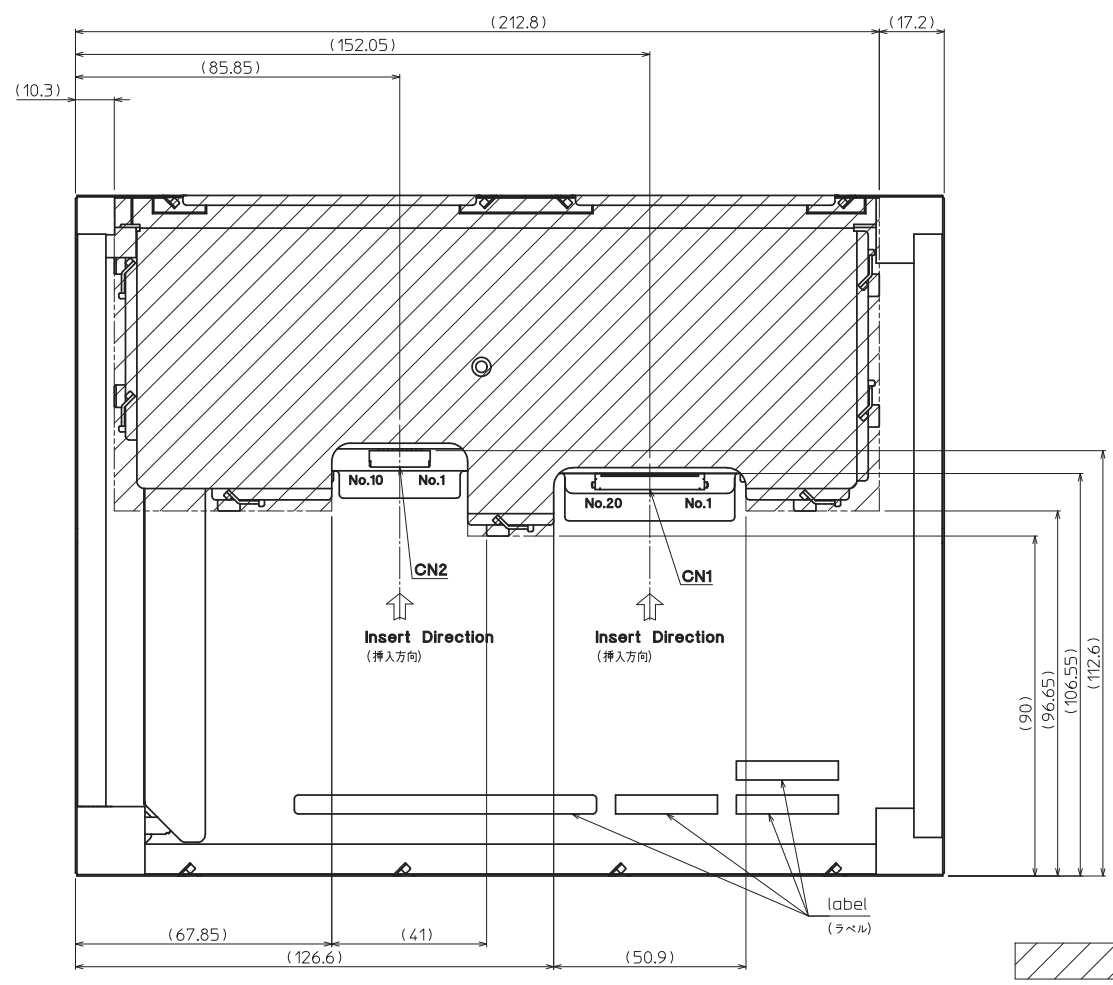
| No | Description | Drawn | Checked | Checked | Approved |
|----|-------------|-------|---------|---------|----------|
| | | | | | |
| | | | | | |



 Projected part is 10.5mm thickness.
(厚み10.5mm)

| | | | | | | | | | |
|-----------------|--------------------|-----------------------|---------|----------------------|-------------|---|------------------------------|-----------------------------|-----------|
| Material 材質 | Treatment 処理 | Approved '15.02.26 | Checked | Checked '15.02.26 | Drawn 倉元 | Scale 1:1 | Title TCG104VGLACANN G03A | Year-Month-Day '15.02.25 | Size 2 |
| Quantity 製作数 | Description: 備考 | RoHS 13232-06448-2 | 加藤 | 蔭山 | 倉元 |  | Outline Dimensions | Drawing No. 121A8084900 | 2/2 |

| | |
|----------|-----------------------|
| Spec No. | TQ3C-8EAF0-E2YAG41-00 |
| Date | March 19, 2015 |

KYOCERA INSPECTION STANDARD

TYPE : TCG104VGLACANN-AN00

KYOCERA DISPLAY CORPORATION

| Original Issue Date | Designed by : Engineering dept. | | | Confirmed by : QA dept. | |
|---------------------|---------------------------------|--------------|----------|-------------------------|----------|
| | Prepared | Checked | Approved | Checked | Approved |
| March 19, 2015 | M. Koyama | Y. Yamaguchi | W. Yano | O. Sato | I. Kamae |

Spec No.
TQ3C-8EAF0-E2YAG41-00

Part No.
TCG104VGLACANN-AN00

Page
-

Revision record

| Date | | Designed by : Engineering dept. | | | Confirmed by : QA dept. | |
|---------|------|---------------------------------|--------------|----------|-------------------------|----------|
| | | Prepared | Checked | Approved | Checked | Approved |
| | | | | | | |
| Rev.No. | Date | Page | Descriptions | | | |
| | | | | | | |

Visuals specification

1) Note

| | Note | |
|-------------------------------|---|--|
| General | <p>1. Customer identified anomalies not defined within this inspection standard shall be reviewed by Kyocera, and an additional standard shall be determined by mutual consent.</p> <p>2. This inspection standard about the image quality shall be applied to any defect within the active area and shall not be applicable to outside of the area.</p> <p>3. Inspection conditions</p> <p>Luminance : 500 Lux min.</p> <p>Inspection distance : 300 mm.</p> <p>Temperature : 25 ± 5°C</p> <p>Direction : Directly above</p> | |
| Definition of inspection item | Dot defect | <p>Bright dot defect</p> <p>The dot is constantly “on” when power applied to the LCD, even when all “Black” data sent to the screen. Inspection tool: 5% Transparency neutral density filter. Count dot: If the dot is visible through the filter. Don't count dot: If the dot is not visible through the filter.</p> <div style="text-align: center;"> </div> |
| | | <p>Black dot defect</p> <p>The dot is constantly “off” when power applied to the LCD, even when all “White” data sent to the screen.</p> |
| | | <p>Adjacent dot</p> <p>Adjacent dot defect is defined as two or more bright dot defects or black dot defects.</p> <div style="text-align: center;"> </div> |
| | External inspection | <p>Bubble, Scratch, Foreign particle (Polarizer, Cell, Backlight)</p> <p>Visible operating (all pixels “Black” or “White”) and non operating.</p> |
| | Appearance inspection | Does not satisfy the value at the spec. |
| Definition of size | <p>Definition of circle size</p> <div style="text-align: center;"> <p>$d = (a + b) / 2$</p> </div> | <p>Definition of linear size</p> <div style="text-align: center;"> </div> |

2) Standard

| Classification | | Inspection item | Judgement standard | | | | | | | | | | | | | | | | |
|--|--|--|--|-----------------------|-------------------|-------------------|-------------------|--------------------|--------------------|---------------------|--------------------|--------------------|--------------------|-----------|-----------|-----------|-----------|---|-------------------------------|
| Defect (in LCD glass) | Dot defect | Bright dot defect | Acceptable number : 4 Bright dot spacing : 5 mm or more | | | | | | | | | | | | | | | | |
| | | Black dot defect | Acceptable number : 5 Black dot spacing : 5 mm or more | | | | | | | | | | | | | | | | |
| | | 2 dot join | Bright dot defect | Acceptable number : 2 | | | | | | | | | | | | | | | |
| | | | Black dot defect | Acceptable number : 3 | | | | | | | | | | | | | | | |
| | | 3 or more dots join | Acceptable number : 0 | | | | | | | | | | | | | | | | |
| | | Total dot defects | Acceptable number : 5 Max | | | | | | | | | | | | | | | | |
| | Others | White dot, Dark dot (Circle) | <table border="1"> <thead> <tr> <th>Size (mm)</th> <th>Acceptable number</th> </tr> </thead> <tbody> <tr> <td>$d \leq 0.2$</td> <td>(Neglected)</td> </tr> <tr> <td>$0.2 < d \leq 0.4$</td> <td>5</td> </tr> <tr> <td>$0.4 < d \leq 0.5$</td> <td>3</td> </tr> <tr> <td>$0.5 < d$</td> <td>0</td> </tr> </tbody> </table> | | | Size (mm) | Acceptable number | $d \leq 0.2$ | (Neglected) | $0.2 < d \leq 0.4$ | 5 | $0.4 < d \leq 0.5$ | 3 | $0.5 < d$ | 0 | | | | |
| Size (mm) | Acceptable number | | | | | | | | | | | | | | | | | | |
| $d \leq 0.2$ | (Neglected) | | | | | | | | | | | | | | | | | | |
| $0.2 < d \leq 0.4$ | 5 | | | | | | | | | | | | | | | | | | |
| $0.4 < d \leq 0.5$ | 3 | | | | | | | | | | | | | | | | | | |
| $0.5 < d$ | 0 | | | | | | | | | | | | | | | | | | |
| External inspection (Defect on Polarizer or between Polarizer and LCD glass) | Polarizer (Scratch) | <table border="1"> <thead> <tr> <th>Width (mm)</th> <th>Length (mm)</th> <th>Acceptable number</th> </tr> </thead> <tbody> <tr> <td>$W \leq 0.1$</td> <td>—</td> <td>(Neglected)</td> </tr> <tr> <td rowspan="2">$0.1 < W \leq 0.3$</td> <td>$L \leq 5.0$</td> <td>(Neglected)</td> </tr> <tr> <td>$5.0 < L$</td> <td>0</td> </tr> <tr> <td>$0.3 < W$</td> <td>—</td> <td>0</td> </tr> </tbody> </table> | | | Width (mm) | Length (mm) | Acceptable number | $W \leq 0.1$ | — | (Neglected) | $0.1 < W \leq 0.3$ | $L \leq 5.0$ | (Neglected) | $5.0 < L$ | 0 | $0.3 < W$ | — | 0 | |
| | | Width (mm) | Length (mm) | Acceptable number | | | | | | | | | | | | | | | |
| | | $W \leq 0.1$ | — | (Neglected) | | | | | | | | | | | | | | | |
| | | $0.1 < W \leq 0.3$ | $L \leq 5.0$ | (Neglected) | | | | | | | | | | | | | | | |
| | $5.0 < L$ | | 0 | | | | | | | | | | | | | | | | |
| | $0.3 < W$ | — | 0 | | | | | | | | | | | | | | | | |
| | Polarizer (Bubble) | <table border="1"> <thead> <tr> <th>Size (mm)</th> <th>Acceptable number</th> </tr> </thead> <tbody> <tr> <td>$d \leq 0.2$</td> <td>(Neglected)</td> </tr> <tr> <td>$0.2 < d \leq 0.3$</td> <td>5</td> </tr> <tr> <td>$0.3 < d \leq 0.5$</td> <td>3</td> </tr> <tr> <td>$0.5 < d$</td> <td>0</td> </tr> </tbody> </table> | | | Size (mm) | Acceptable number | $d \leq 0.2$ | (Neglected) | $0.2 < d \leq 0.3$ | 5 | $0.3 < d \leq 0.5$ | 3 | $0.5 < d$ | 0 | | | | | |
| | | Size (mm) | Acceptable number | | | | | | | | | | | | | | | | |
| | | $d \leq 0.2$ | (Neglected) | | | | | | | | | | | | | | | | |
| | | $0.2 < d \leq 0.3$ | 5 | | | | | | | | | | | | | | | | |
| $0.3 < d \leq 0.5$ | 3 | | | | | | | | | | | | | | | | | | |
| $0.5 < d$ | 0 | | | | | | | | | | | | | | | | | | |
| Foreign particle (Circular shape) | <table border="1"> <thead> <tr> <th>Size (mm)</th> <th>Acceptable number</th> </tr> </thead> <tbody> <tr> <td>$d \leq 0.2$</td> <td>(Neglected)</td> </tr> <tr> <td>$0.2 < d \leq 0.4$</td> <td>5</td> </tr> <tr> <td>$0.4 < d \leq 0.5$</td> <td>3</td> </tr> <tr> <td>$0.5 < d$</td> <td>0</td> </tr> </tbody> </table> | | | Size (mm) | Acceptable number | $d \leq 0.2$ | (Neglected) | $0.2 < d \leq 0.4$ | 5 | $0.4 < d \leq 0.5$ | 3 | $0.5 < d$ | 0 | | | | | | |
| | Size (mm) | Acceptable number | | | | | | | | | | | | | | | | | |
| | $d \leq 0.2$ | (Neglected) | | | | | | | | | | | | | | | | | |
| | $0.2 < d \leq 0.4$ | 5 | | | | | | | | | | | | | | | | | |
| $0.4 < d \leq 0.5$ | 3 | | | | | | | | | | | | | | | | | | |
| $0.5 < d$ | 0 | | | | | | | | | | | | | | | | | | |
| Foreign particle (Linear shape) Scratch | <table border="1"> <thead> <tr> <th>Width (mm)</th> <th>Length (mm)</th> <th>Acceptable number</th> </tr> </thead> <tbody> <tr> <td>$W \leq 0.03$</td> <td>—</td> <td>(Neglected)</td> </tr> <tr> <td rowspan="3">$0.03 < W \leq 0.1$</td> <td>$L \leq 2.0$</td> <td>(Neglected)</td> </tr> <tr> <td>$2.0 < L \leq 4.0$</td> <td>3</td> </tr> <tr> <td>$4.0 < L$</td> <td>0</td> </tr> <tr> <td>$0.1 < W$</td> <td>—</td> <td>(According to circular shape)</td> </tr> </tbody> </table> | | | Width (mm) | Length (mm) | Acceptable number | $W \leq 0.03$ | — | (Neglected) | $0.03 < W \leq 0.1$ | $L \leq 2.0$ | (Neglected) | $2.0 < L \leq 4.0$ | 3 | $4.0 < L$ | 0 | $0.1 < W$ | — | (According to circular shape) |
| | Width (mm) | Length (mm) | Acceptable number | | | | | | | | | | | | | | | | |
| | $W \leq 0.03$ | — | (Neglected) | | | | | | | | | | | | | | | | |
| | $0.03 < W \leq 0.1$ | $L \leq 2.0$ | (Neglected) | | | | | | | | | | | | | | | | |
| | | $2.0 < L \leq 4.0$ | 3 | | | | | | | | | | | | | | | | |
| $4.0 < L$ | | 0 | | | | | | | | | | | | | | | | | |
| $0.1 < W$ | — | (According to circular shape) | | | | | | | | | | | | | | | | | |



ALL TECHNOLOGIES. ALL COMPETENCIES. ONE SPECIALIST.



DATA MODUL AG
Landsberger Straße 322
DE-80687 Munich
Phone: +49-89-56017-0

DATA MODUL WEIKERSHEIM GMBH
Lindenstraße 8
DE-97990 Weikersheim
Phone: +49-7934-101-0



More information and worldwide locations can be found at

www.data-modul.com